

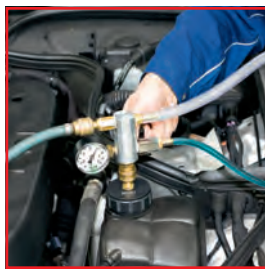

**Specialty Tools**

	<b>Engine</b>		<p>Engine Timing / Timing Belt Spark- and Glow Plug Cylinder Head Valve / Piston Fuel System/Fuel Injection Cooling System / Hose Connection Diagnostics Exhaust System / Lambda Probe</p>	<p>Page 192 ▶ Page 204 ▶ Page 206 ▶ Page 207 ▶ Page 208 ▶ Page 210 ▶ Page 212 ▶ Page 215 ▶</p>	<b>Engine</b>
	<b>Gearbox</b>		<p>Clutch Flywheel</p>	Page 217 ▶	
	<b>Oil Service</b>			Page 219 ▶	<b>Oil Service</b>
	<b>Brakes</b>			Page 223 ▶	
	<b>Chassis</b>		<p>Spring Vice / Shock Absorbers Wheel Bearing / Wheel Hub Silent Block Cardan Shafts Wheels / Tyres</p>	<p>Page 230 ▶ Page 242 ▶ Page 255 ▶ Page 257 ▶ Page 258 ▶</p>	<b>Chassis</b>
	<b>Electricity/ Battery Service</b>		<p>Electrical Testing Battery Service Connections / Plug Connections Generator</p>	<p>Page 261 ▶ Page 262 ▶ Page 263 ▶ Page 266 ▶</p>	
	<b>Body and Interior Equipment</b>		<p>Body Repair Wiper Arm Steering Wheel / Airbag</p>	<p>Page 268 ▶ Page 274 ▶ Page 276 ▶</p>	<b>Body and Interior Equipment</b>
	<b>Borescope / Inspection</b>		<p>Borescope Stethoscope</p>	Page 277 ▶	

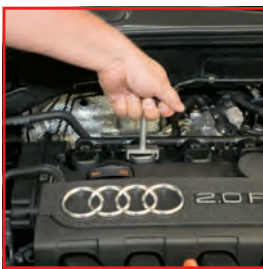

# Engine

Tools for the following fields of application:

- ✓ Engine Timing / Timing Belt
- ✓ Spark- and Glow Plug
- ✓ Cylinder Head
- ✓ Valve / Piston
- ✓ Fuel System / Injection Technology
- ✓ Cooling System / Hose Connection
- ✓ Exhaust System / Lambda Probe
- ✓ Diagnostics



## Engine Timing / Timing Belt

### Pulley Extractor

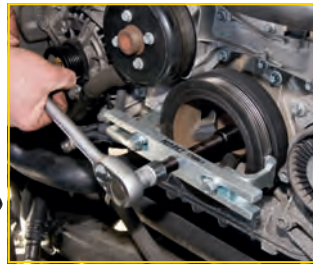

- For pulleys of passenger cars
- Especially suitable for areas with restricted access

**Application:**

Extractor for pulleys **with thread holes**, application with:

- 1 crossbar, short, for pulleys 43–120 mm Ø
- 1 crossbar, long, for pulleys 95–210 mm Ø
- 3 exchangeable pressure pieces, serving as spindle extension

Extractor for pulleys **without thread holes** (hook grip behind pulley), application with:

- 1 crossbar, short, for pulleys 23 - 100 mm Ø
- 1 crossbar, long, for pulleys 85-195 mm Ø
- Puller hooks for a span depth up to 68 mm or extension up to 88 mm

Extractor with **2 groove hooks** (fit into the grooves of the pulley, if gripping behind is not possible), application with:

- 1 crossbar, short, for pulleys 80 - 140 mm Ø
- 1 crossbar, long, for pulleys 135-235 mm Ø

**Made in Germany**

<b>HAZET</b> No.	EAN-No. 4000896+
1789 N-1	158621

## Camshaft Sprocket Extractor

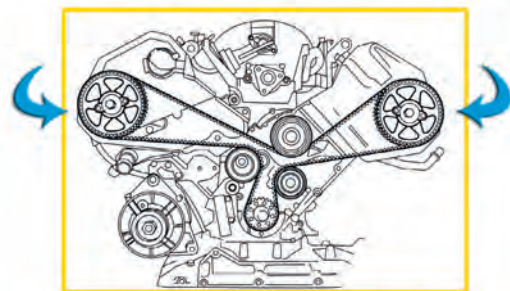
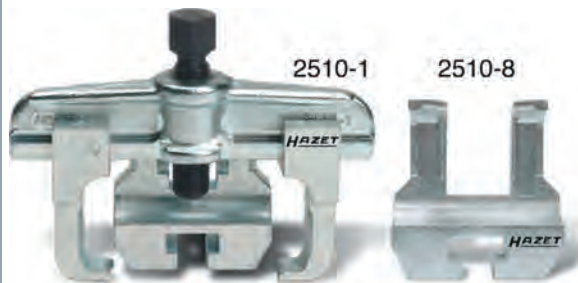

- For the extraction of camshaft sprockets

Application:  
5 and 6-spoke camshaft sprockets on 4 or 6-cyl. engines TDi, engines V6- and V8, AUDI A 4, A 6, A 8

**Made in Germany**

<b>HAZET</b> No.	EAN-No. 4000896+
2510-1	071913
<b>Extractor Hook</b>	
• To supplement Extractor 2510-1.	
• For 5-spoke camshaft sprockets on VW/ AUDI V8 petrol engines	
2510-8	082063





## Timing Belt Pulley Tool



- Retainer with exchangeable pins
- For installing and removing the timing belt pulley on camshaft, crankshaft and fuel injection pump on **VW** Lupo, Polo, New Beetle, Golf, Caddy, Bora, Touran, Sharan, Transporter **AUDI** A2, A3, A4, A6, TT **SKODA** Fabia, Octavia, Superb
- Handle with dip-coating, black
- Surface: chrome-plated

HAZET No.	l mm	EAN-No. 4000896+
2540-1	695	110407

## Timing Belt Double-Pin Wrench



- For adjusting the **timing belt** at the tensioner roller
- On 1.6 l diesel engine **VW** Transporter T3, Golf, Jetta, Passat, **AUDI** 80
- Offset design
- Distance of pins 18 mm, pin  $\varnothing$  2.9 mm

**Made in Germany**

HAZET No.	l mm	EAN-No. 4000896+
2587	140	017140



- For adjusting the timing belt at the tensioner roller
- **VW** Polo since 1995 (4-cyl.), Polo since 2002 (3-cyl. diesel, 4-cyl. with pump-nozzle injection technology), Lupo since 1999 (3-cyl. diesel), Passat TDi since 1998, Golf Plus 2.0 l since 2005 (4-cyl.) **AUDI** A4 since 1995 (4-cyl.), **AUDI** 100 since 1991 (5-cyl.)
- Distance of pins 18 mm, pin- $\varnothing$  3 mm
- Surface: matt chrome-plated

**Made in Germany**

HAZET No.	l mm	EAN-No. 4000896+
2587-1	250	053476



- For adjusting the timing belt at the tensioner roller
- **VW** Golf 3, 4, Golf 5 since 2005 1.9 TDI, 2.0 TDI petrol engine Beetle 2.0 l petrol engine since 2003, Transporter T5 4 cyl. diesel since 2004 **AUDI** A3, **SKODA** Octavia
- Distance of pins 18 mm, pin- $\varnothing$  3 mm
- 15° offset
- Surface: matt chrome-plated

HAZET No.	EAN-No. 4000896+
2587-2	072439



## Application

### Engine Timing Tools

www.hazet.de → Online-Katalog → Produktanwendungen Motoreinstell-Werkzeuge

◀ For Smartphones with QR-Reader (App)

## Engine Timing Tool AUDI, VW, SEAT, SKODA

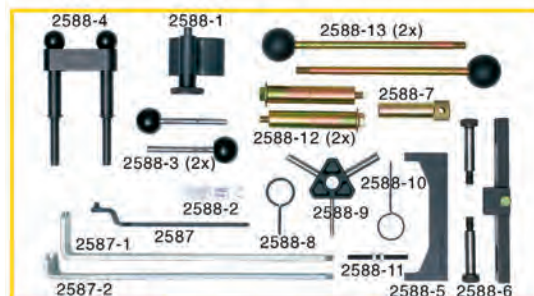
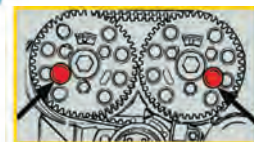

### For the professional engine repair

- For timing belt changing and other engine repairs
- Detailed operating instructions including cross references to original part/tool numbers
- Single parts optionally available
- Clear arrangement in high-quality plastic case with soft foam insert

### Petrol engines:

1.4 1.6 1.8 1.8 T 2.0 16V  
**AUDI** 80, A2, A3, S3, A4, A6, TT  
**SEAT** Arosa, Ibiza, Córdoba, León, Toledo, Inca, Alhambra (1997 up to 2006)  
**SKODA** Fabia, Octavia (since 1996)  
**VW** Lupo, Polo, Caddy, Golf, Bora, New Beetle, Passat, Sharan, Touran

### Diesel engines:

engines with pump-nozzle injection technology 1.2 1.4 1.9 2.0 TDi  
**AUDI** 80, A2, A3, A4, A6, Cabriolet (1995 up to 2000)  
**SEAT** Ibiza, Córdoba, León, Toledo, Inca, Arosa, Alhambra, Altea  
**SKODA** Felicia, Octavia (1993 up to 2005), Fabia  
**VW** Lupo, Polo, Caddy, Golf, Bora, New Beetle, Passat, Sharan, Touran, Transporter, 1.7 1.9 D/TD/SDi/TDi

### Assortment of 19 pieces

Contents:

2587 2587-1 2587-2  
 2588-1 2 3 (2x) 4 5 6 7 8 9 10 11 12 (2x) 13 (2x)

HAZET No.	EAN-No. 4000896+
2588/19	127771
2587	017140
2587-1	053476
2587-2	072439

### Crankshaft Fixing Device

for locking the crankshaft, e.g. VW 1.6 l and 2.0 l Common-Rail diesel engine

2588-1 087730

### Locking Plate

for locking the tensioner roller

2588-2 087747

### Locking Pin

for locking the camshaft sprocket e.g. VW 1.6 l and 2.0 l Common-Rail diesel engine

2588-3 087754

Continuation see next page ▶

## Engine Timing Tool AUDI, VW, SEAT, SKODA



HAZET No.	EAN-No. 4000896+
<b>Camshaft locking</b> for locking the camshaft sprockets when changing the timing belt	
<b>2588-4</b>	110391
Camshaft Setting Plate	
<b>2588-5</b>	137107
<b>2588-6</b>	137114
Locking Pin	
<b>2588-7</b>	136896
Locking Pin for tensioning tool	
<b>2588-8</b>	137121
Setting Tool	
<b>2588-9</b>	137565
Locking Pin	
<b>2588-10</b>	136902
Retainer	
<b>2588-11</b>	137572
Support Guides	
<b>2588-12</b>	137589
<b>2588-13</b>	137596

## Engine Timing Tool AUDI, VW, SEAT, SKODA



HAZET No.	EAN-No. 4000896+
Fixing Bolt	
<b>2588-14</b>	144198
<b>2588-15</b>	144204
<b>2588-16</b>	144211
Tension Pulley Screw	
<b>2588-17</b>	144228
Fixing tool for tension pulley	
<b>2588-18</b>	144334
Fixing tool	
<b>2588-19</b>	144341
For 4-cyl. diesel / pump-nozzle injection engines since 2005 e.g. VW 2.0 l Common-Rail diesel engine	
Crankshaft Fixing Device	
For fixing the <b>oval</b> crankshaft timing belt pulley e.g. during timing belt replacement or engine repair	
<b>2588-110</b>	143283
TDC Position Tool, application with dial gauge 2155-65	
<b>3688-10</b>	137527

## Fixing Bolt Set



### For the professional engine repair

- Fixing bolts for the crankshaft and camshaft on 3-cyl. engines
- 1.2 6V and 12 V 3-cyl. engines, **VW** Polo, Fox, **SKODA** Fabia, **SEAT** Ibiza, Cordoba
- **4 pieces**

### Contents:

2588-14 15 (2x) 16

HAZET No.	EAN-No. 4000896+
<b>2588/4</b>	164653
Fixing Bolt	
<b>2588-14</b>	144198
<b>2588-15</b>	144204
<b>2588-16</b>	144211

## Tool Set for Timing Belt Replacement

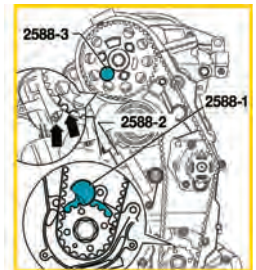

### For timing belt replacement, e.g. on VW engines with pump-nozzle injection technology since 1999

- **AUDI** A2, A3, A6, **VW** Passat, Golf, Bora, Beetle, Sharan, Lupo and Touran, **SEAT** Alhambra, Arosa, **SKODA** Octavia, Fabia, Superb, **FORD** Galaxy
- The use of this tool set ensures that the engine timing is retained when changing timing belt or when carrying out engine maintenance work

### Contents:

Crankshaft Fixing Device 2588-1  
Locking Plate 2588-2  
Locking Pin 2588-3

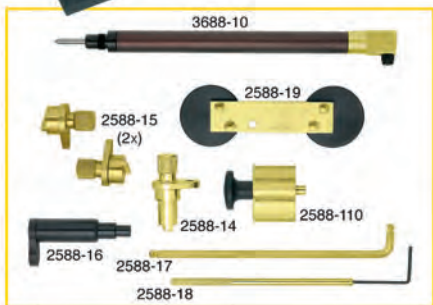

### For the professional engine repair

Expansion for Assortment 2588/19

**Petrol engines:** 1.2 6V and 12V 3-cylinder engine, **VW** Polo and Fox, **SKODA** Fabia, **SEAT** Ibiza / Córdoba

**1.4-1.6 FSI engines:** **AUDI** A3, **SKODA** Octavia, **VW** Polo, Golf, Touran, Tiguan, EOS, Passat

**Diesel engines:** 4-cylinder engines with pump-nozzle injection technology since 2005 **VW** and **VW** group vehicles

**Set of 9 pieces** in soft foam insert (may be stored in tool case 2588/19)

### Contents:

2588-14 15 (2x) 16 17 18 19 110  
3688-10

HAZET No.	EAN-No. 4000896+
<b>2588/9</b>	144181





## Tool Set for Timing Belt Replacement

HAZET No.	EAN-No. 4000896+
2588/3	087761
<b>Crankshaft Fixing Device</b> for locking the crankshaft, e.g. VW 1.6 l and 2.0 l Common-Rail diesel engine	
2588-1	087730
<b>Locking Plate</b> for locking the tensioner roller	
2588-2	087747
<b>Locking Pin</b> for locking the camshaft sprocket e.g. VW 1.6 l and 2.0 l Common-Rail diesel engine	
2588-3	087754

## Camshaft Locking Tool

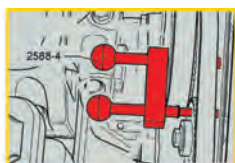
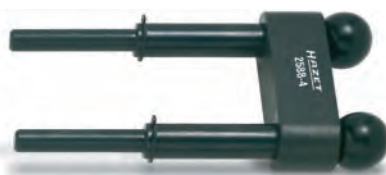

### For the professional engine repair

- For locking the camshaft sprockets when changing the timing belt
- Engine repairs on 4 valve 4 cyl. injection engines  
VW Lupo since 1999, Polo since 1995, Caddy since 1996  
Polo Classic, Variant since 1996, New Beetle 1.4 l since 1999  
Golf 1.4 l, 1.6 l since 1998, Bora 1.4 l, 1.6 l since 1999  
SKODA Fabia and Octavia  
AUDI A2

HAZET No.	EAN-No. 4000896+
2588-4	110391

## Engine Timing Tool BMW

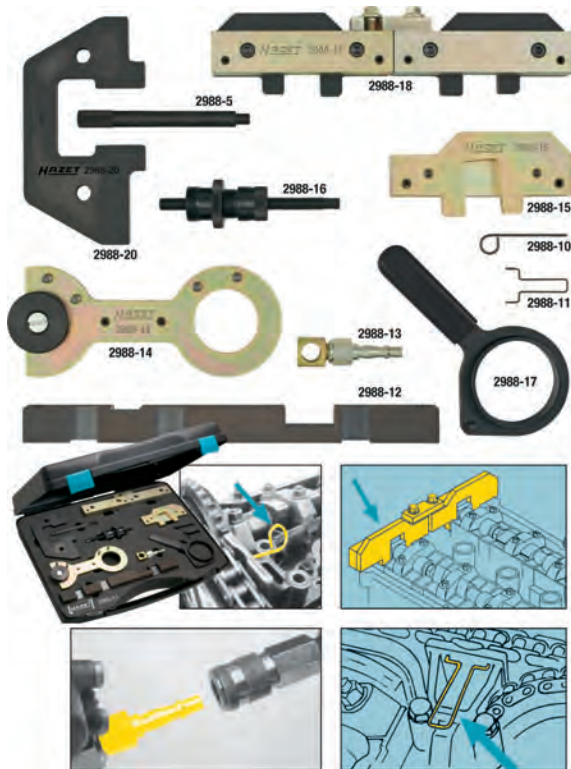

### For the professional engine repair

- Installation and removal of the camshaft/variable camshaft timing unit
- Checking and adjustment of camshaft timing
- Detailed operating instructions including cross references to original part/tool numbers
- Clear arrangement in high-quality plastic case with soft foam insert

## Engine Timing Tool BMW

For BMW petrol engines: M40, M43  
with twin camshafts: M42, M44, M50, M52, M54, M56

- Installation, removal and timing of variable camshaft timing unit
- Checking and adjustment of camshaft timing/timing belt changing

### BMW:

E36:	316i year 1993–99
E46:	316i year 1999–2004 / 316i Compact year 1994–2001 (M43)
E36:	318i year 1993–99 (M43)
E46:	318i year 1998–04 (M43)
E30:	318iS-16V, year 1989–91 (M42)
E36:	318iS/ Coupé year 1992–98 / 318tCompact year 1994–98 (M42)
	318iS/ Coupé year 1996–99 / 318tCompact year 1996–2001 (M44)
	320i year 1991–97
	320i year 1991–99 – Single Vanos (M52)
E36/E46:	320i year 1998–2006 – Twin Vanos
	323i Compact year 1995–2001 – Single Vanos
E46:	323i year 1998–2001 – Twin Vanos (M52)
E36:	325i year 1991–97 / 325i year 1991–97 – Single Vanos
E46:	325i Compact year 2000–06 – Twin Vanos (M52)
E38:	328i year 1995–99 – Single/Vanos
E46:	328i year 1998–2001 – Twin/Vanos
	330i year 2000–06 – Twin/Vanos
E34:	518i year 1994–96 (M43)
	520i year 1989–96
E43:	520i year 1989–96 – Single/Vanos
E39:	520i year 1995–99 – Single/Vanos
	520i year 1998–2003 – Twin Vanos
E60/6:	year 2003–05 – Twin/Vanos
E39:	523i year 1995–99 – Single/Vanos
	523i year 1998–2001 – Twin/Vanos
E34:	525i year 1989–96
	525i year 1989–96 – Single/Vanos
E39:	525i year 2000–03 – Twin/Vanos
E60/E61:	525i year 2003–05 – Twin/Vanos
E39:	528i year 1996–2000 – Single/Vanos
	528i year 1998–2001 – Twin Vanos (M52)
	530i year 2000–03 – Twin/Vanos
E60/61:	530i year 2003–05 – Twin/Vanos
E38:	728i year 1995–98 – Single/Vanos
	728i year 1998–2002 – Twin/Vanos
E65/E66:	730i year 2002–05 – Twin/Vanos
E83:	X3-2.5l year 2003–06 – Twin/Vanos
	X3-3.0l year 2003–06 – Twin/Vanos
E53:	X5-3.0l year 1999–2005 – Twin/Vanos (M54)
	Z3-1.8i year 1996–99
	1.9i year 1999–2003 (M43/M44)
	2.0i year 1999–2003 – Twin Vanos (M52)
	2.2i year 2000–03 – Twin Vanos (M52)
	2.8i year 1997–99 – Single/Vanos
	2.8i year 2000–03 – Twin/Vanos
	3.0i year 2000–03 – Twin Vanos (M54)
E85:	Z4-2.2l year 2003–06 – Twin/Vanos
	2.5l year 2003–06 – Twin/Vanos
	3.0l year 2003–06 – Twin/Vanos

### Assortment of 11 pieces

Contents:

2988-5	10	11	12	13	14
	15	16	17	18	20

HAZET No.	EAN-No. 4000896+
2988/11	148721
Crankshaft Locking Tool	
2988-5	149698
Locking Pin	
2988-10	149872
Chain Tensioner Locking Pin	
2988-11	149889
Camshaft Setting Plate	
2988-12	149896
Compressed Air Connection	
2988-13	149902
Mounting Plate, adjustable	
2988-14	149919
Camshaft Setting Plate	
2988-15	149926
Chain Tensioner	
2988-16	149933
Timing Chain Tool	
2988-17	149940
Camshaft Setting Plate	
2988-18	149957
Camshaft Setting Plate	
2988-20	149971

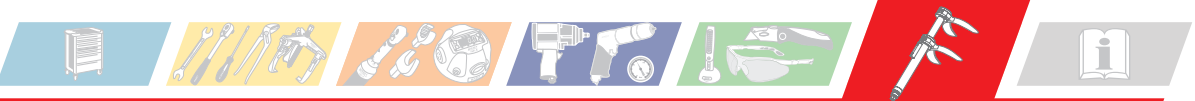

**Engine Timing Tool BMW**

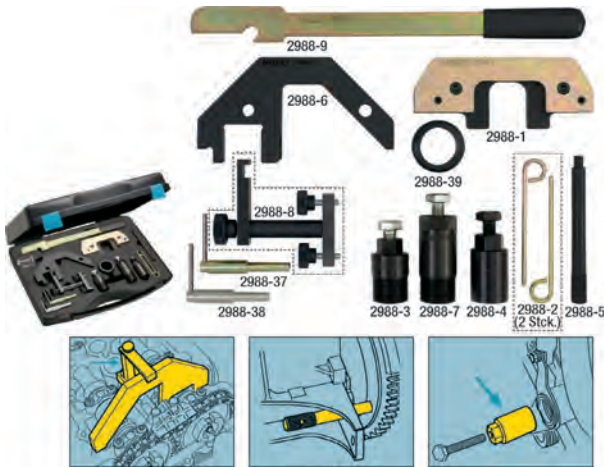

**For the professional engine repair**

- Installation and removal of the camshaft/variable camshaft timing unit
  - Checking and adjustment of camshaft timing
  - Detailed operating instructions including cross references to original part/tool numbers
  - Clear arrangement in high-quality plastic case with soft foam insert
- For **BMW** diesel engines M 41, M 51, M 47–M 47 TU/T2, M 57 / TU / T2:2.0l / 3.0l year 1998–2008
- Installation and removal of the camshaft/hydraulic chain tensioner
  - Checking and adjustment of camshaft timing

**BMW:**

E36:	318tds/318tds Compact model years 1994–2000 / 325td / td model years 1991–1999
E34/E39:	525td/ tds model years 1991–2003
E38:	725tds model years 1991–2003 M47/ M47 TU /T2/ M57 TU / T2
E87:	118d / 120d
E46:	318d / 318td Compact / 320td Compact/ 320d / 330d
E39:	520d / 525d / 530d
E60/E61:	525d / 530d / 535d
E63:	635d
E38/E65/E66:	730d
E83:	X3, 2.0 l d / 3.0 l d
E53/E70:	X5, 3.0 l d
E90/E91:	316i, 316ti, 318ci, 318ti, 320i
E90/E91/E92/E93:	318i, 320i

**ROVER**

- Range Rover: 2.5 DT model years 1994–2002
- Range Rover: 3.0 TD6 model years 2002–2006
- Freelander: 2.0 TD4 model years 2002–2006

**Assortment of 13 pieces**

Contents:

2988-1	2 (2x)	3	4	5	6
	7	8	9	37	38
			37	38	39

HAZET No.	EAN-No. 4000896+
<b>2988/13</b>	148714
Camshaft Setting Plate	
<b>2988-1</b>	149650
Locking Pin	
<b>2988-2</b>	149667
Injection Pump Remover, short	
<b>2988-3</b>	149674
Timing Chain Retainer	
<b>2988-4</b>	149681
Crankshaft Locking Tool	
<b>2988-5</b>	149698
Camshaft Setting Plate	
<b>2988-6</b>	149704
Injection Pump Remover, long	
<b>2988-7</b>	149711
Camshaft Plate Locking Tool	
<b>2988-8</b>	149728
Timing Chain Lever	
<b>2988-9</b>	149834
Locking Pin, bent	
<b>2988-37</b>	149841
<b>2988-38</b>	149858
Support Sleeve	
<b>2988-39</b>	149865

**Engine Timing Tool BMW**

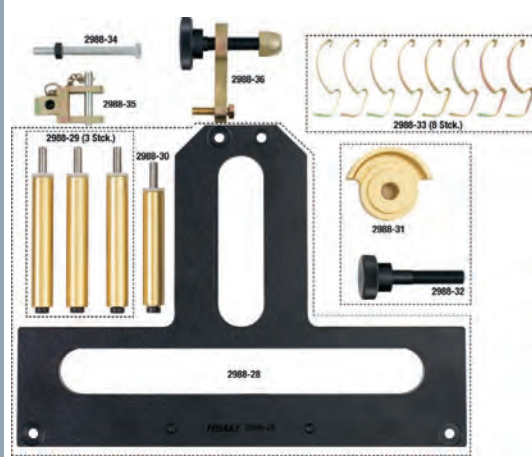

**For the professional engine repair**

- Installation and removal of the camshaft/variable camshaft timing unit
  - Checking and adjustment of camshaft timing
  - Detailed operating instructions including cross references to original part/tool numbers
  - Clear arrangement in high-quality plastic case with soft foam insert
- For **BMW** petrol engines N42, N46

**Assortment of 18 pieces**

Contents:

2988-28	29 (3x)	30	31	32	33 (8x)	34	35	36
---------	---------	----	----	----	---------	----	----	----

HAZET No.	EAN-No. 4000896+
<b>2988/18</b>	149742
Carrier Bracket Mounting Fixture	
<b>2988-28</b>	150052
Stud Bolt, long	
<b>2988-29</b>	150069
Stud Bolt, short	
<b>2988-30</b>	150076
Inlet Camshaft Securing Tool	
<b>2988-31</b>	150083
Knurled screw	
<b>2988-32</b>	150090
Intermediate Lever Clamp	
<b>2988-33</b>	150106
Bolt and Nut	
<b>2988-34</b>	150113
Torsion Spring Tool	
<b>2988-35</b>	150120
Eccentric Shaft Holder	
<b>2988-36</b>	150137

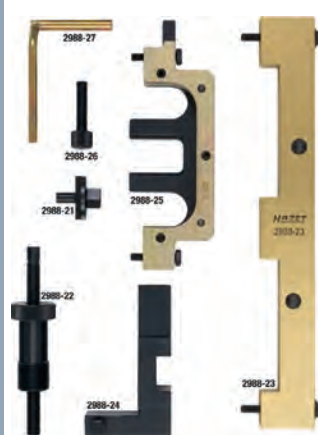

**For the professional engine repair**

- Installation and removal of the camshaft/variable camshaft timing unit
  - Checking and adjustment of camshaft timing
  - Detailed operating instructions including cross references to original part/tool numbers
  - Clear arrangement in high-quality plastic case with soft foam insert
- For **BMW** petrol engines N42, N46





## Engine Timing Tool BMW

7 pieces, in plastic case

Contents:

2988-21 22 23 24 25 26 27

HAZET No.	EAN-No. 4000896+
2988-7	149735
Camshaft Turning Tool	
2988-21	149988
Timing Chain Tensioner Pre-Load Tool	
2988-22	149995
Sensor Wheel Locking Tool	
2988-23	150007
Camshaft Setting Plate	
2988-24	150014
Camshaft Setting Plate	
2988-25	150021
Fixing Screw	
2988-26	150038
Locking Pin, bent	
2988-27	150045



### For the professional engine repair

- Installation and removal of the camshaft / variable camshaft timing unit
- Checking and adjustment of camshaft timing
- Detailed operating instructions including cross references to original part/tool numbers
- Clear arrangement in high-quality plastic case with soft foam insert
- **Assortment of 25 pieces** as complete set 2988/25, consisting of two cases 2988/7 and 2988/18 (Components / single sets see table above)
- Installation and removal of the camshaft / variable camshaft timing unit
- Checking and adjustment of camshaft timing
- Set consisting of 2 cases

### BMW:

E87: 118i / 120i – N46 engine  
 E46: 316i / 316ti / 318i / 318i N42 engine  
 E90 / E91: 318i / 320i – N46 engine  
 E85: Z4, 2.0 I – N46 engine

HAZET No.	EAN-No. 4000896+
2988/25	149759

## Engine Timing Tool OPEL

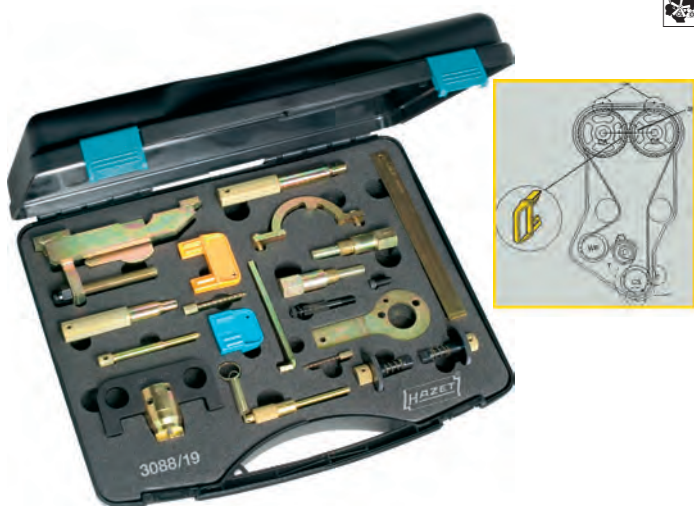

## Engine Timing Tool OPEL

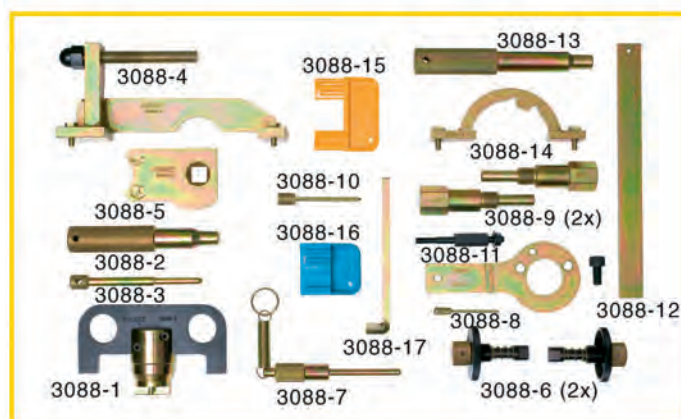

### For the professional engine repair

- For timing belt changing and other engine repairs
- Detailed operating instructions including cross references to original part / tool numbers
- Clear arrangement in high-quality plastic case with soft foam insert

### Eco Tec petrol engines:

1.0 12V 1.2 16V (since 1997) and twin camshaft engines  
 1.4 1.6 1.8 2.0 2.2 16V (since 1995)

OPEL Agila, Astra, Corsa, Tigra, Vectra, Zafira, Omega, Frontera, Sintra, Signum, Meriva

### Eco Tec diesel engines: 1.3 CDTi 16V 1.9 CDTi 2.0 2.2 DTi

OPEL Agila, Astra, Corsa, Vectra, Tigra, Combo-C, Zafira, Omega, Frontera, Sintra, Signum

### Assortment of 19 pieces

Contents:

3088-1 2 3 4 5 6 (2x) 7 8 9 (2x)  
 10 11 12 13 14 15 16 17

HAZET No.	EAN-No. 4000896+
3088/19	127788
Camshaft Setting Tool	
3088-1	137138
Crankshaft Locking Tool	
3088-2	136704
Injection Pump Locking Pin	
3088-3	136711
Cam Sprocket Attachment	
3088-4	137602
3088-5	137077
Camshaft Setting Tool (price per piece – to be used in pairs)	
3088-6	137145
Flywheel (Crankshaft) Locking Pin	
3088-7	136728
Chain Tensioner Retaining Pin	
3088-8	136735
Camshaft Setting Tool	
3088-9	137213
Auxiliary Belt Tensioner Locking Pin	
3088-10	136759
Crankshaft Locking Tool	
3088-11	136742
Camshaft Setting Plate	
3088-12	137091
Crankshaft Locking Pin	
3088-13	137473
Camshaft Setting Tool	
3088-14	137183
Camshaft Setting Tool (yellow)	
3088-15	137190
Camshaft Setting Tool (blue)	
3088-16	137206
Flywheel Holding Tool	
3088-17	137480

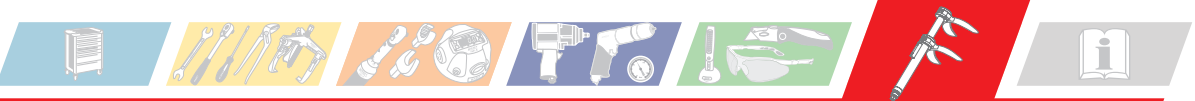

Engine

### Engine Timing Tool OPEL

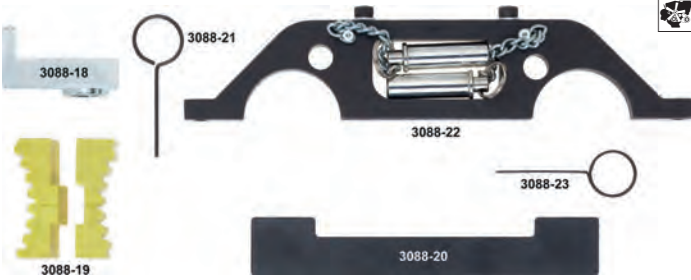

#### For the professional engine repair

- For timing belt changing and other engine repairs
- **Supplementary Set, 6 pieces, in soft foam insert**
- For OPEL 1.6 and 1.8-16V "TWINPORT" petrol engines: Corsa D, Astra G, H, Vectra C, Signum, Meriva, Zafira B
- 2.2-16 V petrol engines: Astra G, H, Vectra C, Signum, Speedster/Vauxhall VX220, Zafira A, B
- Camshaft locking when replacing the timing belt
- Camshaft timing/engine timing/timing chain tensioner
- Crankshaft Positioning

Contents:

3088-18 19 20 21 22 23

HAZET No.	EAN-No. 4000896+
3088/7	155941
Flywheel Holding Tool	
3088-18	155958
Camshaft Sprocket Locking Tool	
3088-19	155965
Camshaft Setting Plate	
3088-20	155972
Locking Pin for Chain Tensioner	
3088-21	155989
Camshaft Setting Tool	
3088-22	155996
Chain Tensioner Locking Pin	
3088-23	156009

### Engine Timing Tool FORD

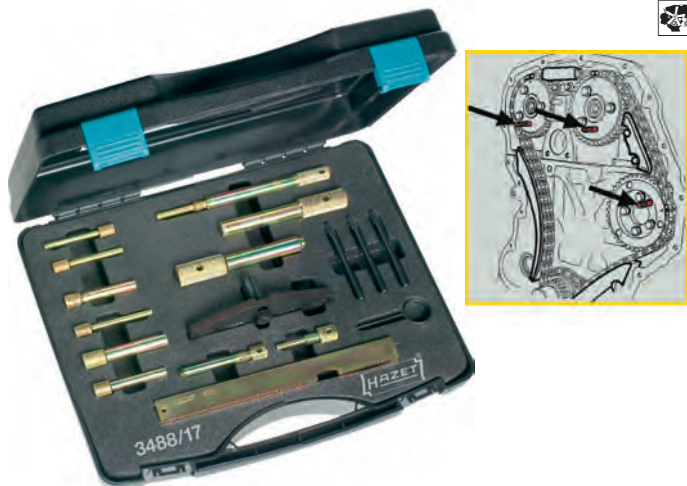

### Engine Timing Tool FORD

#### For the professional engine repair

- For timing belt changing and other engine repairs
- Detailed operating instructions including cross references to original part/tool numbers
- Clear arrangement in high-quality plastic case with soft foam insert

#### Petrol engines:

Twin camshaft engines (Zetec/Duratec)  
1.25 1.4 1.6 1.7 1.8 2.0 16V

**FORD** Fiesta, Escort, Focus, Focus C-Max, Puma, Fusion, Mondeo, Cougar (1998 up to 2001)

#### Diesel engines:

1.8 D / TD / TDCi / TDd2.0 / 2.4TDdi 1.4 / 1.6 TDci

**FORD** Fiesta, Escort, Orion, Courier, Focus, Focus C-Max, Mondeo (1988 up to 2003), Fusion, Transit

#### Assortment of 17 pieces

Contents:

3488-1 2 (2x) 3 4 5 6  
7 8 (3x) 9 10 11  
3788-21 22 23

HAZET No.	EAN-No. 4000896+
3488/17	127795
Camshaft Setting Plate	
3488-1	137084
Locking Pin	
3488-2	136797
3488-3	136803
Crankshaft TDC Location Pin	
3488-4	137497
Flywheel Locking Tool	
3488-5	137060
Locking Pin	
3488-6	136810
3488-7	136827
Camshaft and Injection Pump Locking Pins	
3488-8	136834
Chain Tensioner Locking Pin	
3488-9	136841
Crankshaft Location Pin	
3488-10	136773
3488-11	136780
Injection Pump and Crankshaft Locking Pin	
3788-21	136858
Flywheel Locking Tool	
3788-22	136865
Camshaft Locking Pin	
3788-23	136766



#### For the professional engine repair

- For timing belt changing and other engine repairs
- **Supplementary Set, 8 pieces, in soft foam insert**
- For FORD 1.25-1.4 and 1.6-16V petrol engines: Fiesta, Fusion, Focus, C-Max
- 1.6 Ti-VCT-petrol engines: Focus, C-Max
- 1.4-1.6 TDCi-Diesel: Fiesta, Fusion, Focus, C-Max
- 2.0 TDCi-diesel: Focus, Mondeo, C-Max, S-Max, Galaxy
- Camshaft locking when replacing the timing belt
- Camshaft timing/engine timing/timing chain tensioner

Contents:

2588-8  
3488-12 13 14 15 16 17  
3788-21

HAZET No.	EAN-No. 4000896+
3488/8	155873





## Engine Timing Tool FORD

HAZET No.	EAN-No. 4000896+
Locking Pin for tensioning tool <b>2588-8</b>	137121
Flywheel Locking Pin, bent <b>3488-12</b>	155897
Camshaft Setting Plate <b>3488-13</b>	155880
Camshaft Sprocket Holding Tool <b>3488-14</b>	155903
Crankshaft Locking Tool <b>3488-15</b>	155910
Adapter <b>3488-16</b> <b>3488-17</b>	155927 155934
Injection Pump and Crankshaft Locking Pin <b>3788-21</b>	136858

## Engine Timing Tool FIAT



### For the professional engine repair

- For timing belt changing and other engine repairs
- Detailed operating instructions including cross references to original part/tool numbers
- Clear arrangement in high-quality plastic case with soft foam insert

#### Petrol engines:

Twin camshaft engines 1.2 – 1.4 – 1.6 – 1.8 6V

FIAT Brava/Bravo, Barchetta, Cargo, Coupé, Marea, Palio/Weekend, Punto, Multipla, Stilo, Idea, Doblo, Marea/Weekend

#### Diesel engines:

JTD-Diesel engines 1.9 D/TD – 1.9 JTD – 2.4 TD/JTD  
Brava/Bravo, Cargo, Marea/Weekend, Palio/Weekend, Punto, Multipla, Stilo, Doblo, Ulysee, Ducato, Scudo

#### Assortment of 20 pieces

Contents:

3088-11  
3688-1 (2x) 2 (2x) 3 5 6 7 8 10 12 13 41 42  
3788-1 5 8 12  
2100-04

HAZET No.	EAN-No. 4000896+
<b>3688/20</b>	167265
Crankshaft Locking Tool <b>3088-11</b>	136742
Piston Position Tools <b>3688-1</b>	137343

## Engine Timing Tool FIAT

HAZET No.	EAN-No. 4000896+
Camshaft Setting Tool <b>3688-2</b>	137220
Double Pin Wrench <b>3688-3</b>	137329
Tensioner Adjuster <b>3688-5</b>	137336
Flywheel Holding Tool <b>3688-6</b>	137053
Camshaft Setting Plate (Exhaust) <b>3688-7</b>	166152
Camshaft Setting Plate (Inlet) <b>3688-8</b>	166169
TDC Position Tool, application with dial gauge 2155-65 <b>3688-10</b>	137527
Flywheel Holding Tool <b>3688-12</b>	137367
Balancer Shaft Belt Tensioner Adjuster <b>3688-13</b>	137374
Camshaft Setting Plate <b>3688-41</b> <b>3688-42</b>	137237 137244
Crankshaft/Flywheel TDC Locking Pin <b>3788-1</b>	136643
Locking Pin/Bolt <b>3788-5</b>	136513
Camshaft and Injection Pump Locking Bolt/Pin <b>3788-8</b>	136544
Holding Tool for Crank Shaft Pulley Removal <b>3788-12</b>	137015
Hex Head Wrench <b>2100-04</b>	011322

## Engine Timing Tool ALFA

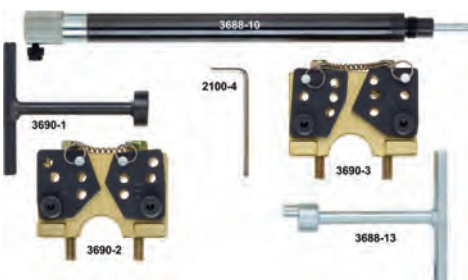

### For the professional engine repair

- For timing belt changing and other engine repairs
- For **ALFA-ROMEO** 1.4 – 1.6 – 1.8 and 2.0-16V-TWINSPARK since 1995 and 2.0 JTS-petrol engine: 145, 146, 147, 155, 156, 166, Spider, GTV, GT
- Camshaft locking when replacing the timing belt
- Camshaft timing as well as TDC determination
- Assortment of 6 pieces

Contents:

2100-04 3688-10 13 3690-1 2 3

HAZET No.	EAN-No. 4000896+
<b>3690/6</b>	156016
Balancer Shaft Belt Tensioner Adjuster <b>3690-1</b>	156023
Camshaft Setting Plate (Inlet) <b>3690-2</b>	156030
Camshaft Setting Plate (Exhaust) <b>3690-3</b>	156047
TDC Position Tool, application with dial gauge 2155-65 <b>3688-10</b>	137527
Balancer Shaft Belt Tensioner Adjuster <b>3688-13</b>	137374
Hex Head Wrench <b>2100-04</b>	011322

Engine

**Engine Timing Tool CITROËN / PEUGEOT**

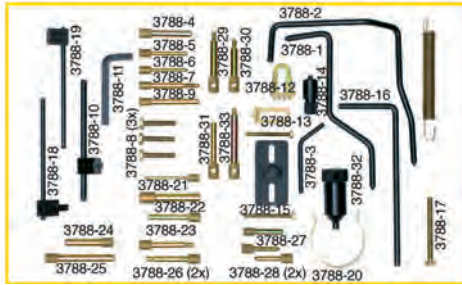
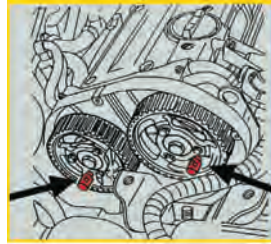

**For the professional engine repair**

- For timing belt changing and other engine repairs
- Detailed operating instructions including cross references to original part/tool numbers
- Clear arrangement in high-quality plastic case with soft foam insert

**Petrol engines:**

1.0 1.1 1.4 1.6 1.8 1.9 2.0 Turbo  
as well as twin camshaft engines  
1.6 1.8 2.0 2.2 16V

**CITROËN** AX, BX, ZX, XM, Saxo, Xsara, Xantia, Synergie/Evasion, Berlingo, Dispatch/Jumpy, C 15, Relay/Jumper, Synergie, C 5 (2000 up to 2002), C 8  
**PEUGEOT** 106, 205, 206, 306, 307, 309, 405, 406, 407, 605, 806, 807, Expert, Partner, Boxer (since 1986), 406 Coupé, 607

**Diesel engines:**

1.4 1.5 1.7 1.8 1.9 2.1 2.5 D/TD/TDi  
and HDI diesel engines  
1.4 1.6 2.0 2.2

**CITROËN** AX, ZX, XM, Visa, Xsara, Xantia, Dispatch, Synergie/Evasion, Berlingo, Dispatch, Jumpy, C 2, C 3, C 5, Relay/Jumper

**PEUGEOT** 106, 205, 206, 305, 306, 307, 309, 405, 406, 406 Coupé, 605, 607, 806, 807, Express, Expert, Partner, Boxer (since 1986)

**Assortment of 37 pieces**

Contents:

3788-1 2 3 (3x) 4 5 6 7 8 9 10 11  
12 13 14 15 16 17 18 19 20 21 22 23  
24 25 26 (2x) 27 28 (2x) 29 30 31 32 33

HAZET No.	FAN-No. 4000896+
<b>3788/37</b>	127740
Crankshaft/Flywheel TDC Locking Pin	
<b>3788-1</b>	136643
<b>3788-2</b>	136650
<b>3788-3</b>	136667
Injection Pump Locking Pin	
<b>3788-4</b>	136506
Locking Pin/Bolt	
<b>3788-5</b>	136513
Injection Pump Locking Bolt/Pin	
<b>3788-6</b>	136520
Camshaft Locking Bolt/Pin	
<b>3788-7</b>	136537
Camshaft and Injection Pump Locking Bolt/Pin	
<b>3788-8</b>	136544
Tensioner Setting Pin	
<b>3788-9</b>	136551
Special Wrench for Tensioner Roller	
<b>3788-10</b>	136964
<b>3788-11</b>	136971
Holding Tool for Crank Shaft Pulley Removal	
<b>3788-12</b>	137015
Flywheel locking tool for the removal of the crank shaft pulley	
<b>3788-13</b>	137022

**Engine Timing Tool CITROËN / PEUGEOT**

HAZET No.	FAN-No. 4000896+
Holding Tool for Crank Shaft Pulley Removal	
<b>3788-14</b>	137039
Crankshaft Pulley Remover	
<b>3788-15</b>	137152
Flywheel TDC Locking Pin	
<b>3788-16</b>	137008
Locking Bolt	
<b>3788-17</b>	137169
Balancer Shaft Belt Tensioner Adjuster	
<b>3788-18</b>	136988
<b>3788-19</b>	136995
Timing Belt Retaining Clip	
<b>3788-20</b>	137176
Injection Pump and Crankshaft Locking Pin	
<b>3788-21</b>	136858
Flywheel Locking Tool	
<b>3788-22</b>	136865
Camshaft Locking Pin	
<b>3788-23</b>	136766
Crankshaft/Flywheel TDC Locking Pin	
<b>3788-24</b>	136957
Locking Pin	
<b>3788-25</b>	136919
<b>3788-26</b>	136926
<b>3788-27</b>	136933
<b>3788-28</b>	136940
Camshaft Locking Pin	
<b>3788-29</b>	136568
<b>3788-30</b>	136674
Crankshaft Locking Tool	
<b>3788-31</b>	136681
Flywheel Holding Tool	
<b>3788-32</b>	137046
Camshaft Locking Pin	
<b>3788-33</b>	136698

**Engine Timing Tool RENAULT**

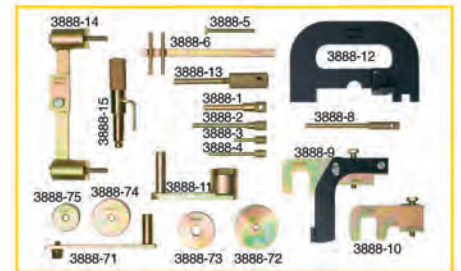
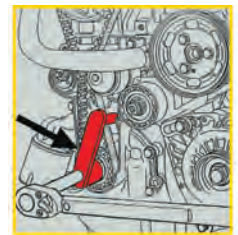

**For the professional engine repair**

- For timing belt changing and other engine repairs
- Detailed operating instructions including cross references to original part/tool numbers
- Clear arrangement in high-quality plastic case with soft foam insert

**Petrol engines:**

twin camshaft engines  
1.2 1.4 1.6 1.8 2.0 16V 2.5 20V

**RENAULT** Clio, Twingo, R 19, Mégane, Scenic, Laguna, Safrane, Espace, Express/Extra, Rapid, Kangoo





## Engine Timing Tool RENAULT

### Diesel engines:

1.9 D/TD/d Ti 2.2 D/TD 2.5 D 2.8 d Ti  
1.5 d Ci 1.9 d Ci 2.2 d Ci 2.5 d Ci

**RENAULT** Clio, Express/Extra, Mégane, Scenic, Laguna, Espace, Safrane, Kangoo, Trafic, Master, Vel Satis, R 5, R 19, Rapid

**OPEL** Vivano, Movano 2.5CDTI, Motorcode G9U

### Assortment of 19 pieces

Contents:

3888-1 2 3 4 5 6 8 9 10 11  
12 13 14 15 71 72 73 74 75

HAZET No.	EAN-No. 4000896+
3888/19	127733
Crankshaft TDC Locking Pin	
3888-1	136575
3888-2	136582
Setting Pin	
3888-3	136599
3888-4	136605
Adjuster	
3888-5	137251
Double Pin Wrench	
3888-6	137268
Crankshaft Locking Tool	
3888-8	136612
Camshaft Setting Plate (Exhaust)	
3888-9	137275
Camshaft Setting Plate (Inlet)	
3888-10	137282
Tensioning Tool	
3888-11	137299
Camshaft Setting Plate	
3888-12	137305
Crankshaft Locking Tool	
3888-13	136629
Camshaft Setting Plate	
3888-14	137312
Setting Pin	
3888-15	136636
Arm	
3888-71	137503
Adapter	
3888-72	137442
Spacer	
3888-73	137510
Adapter	
3888-74	137459
3888-75	137466

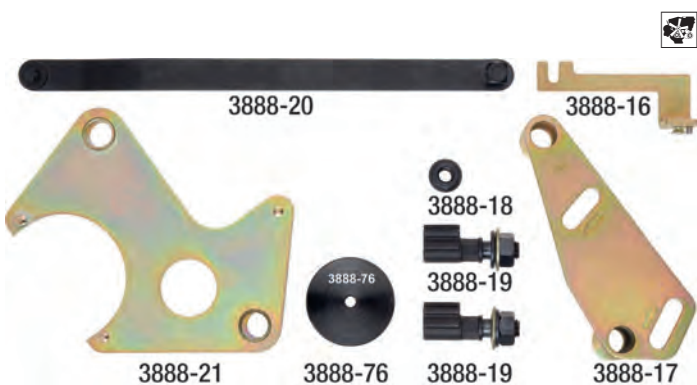

### For the professional engine repair

- For timing belt changing and other engine repairs
- **Supplementary Set, 8 pieces, in soft foam insert**
- For **RENAULT** 1.4 and 1.6-16V petrol engines: Clio 3, Megane 2, Scenic 2, Laguna 2, Modus, Kangoo
- 1.8 and 2.0-16V petrol engines: Clio 2, Megane 1/2, Scenic 1/2, Laguna 1/2, Espace JEO/JKO, Trafic 2
- 1.9 dCi Diesel: Megane 2, Laguna 2, Espace/Grand Espace 2
- Camshaft locking when replacing the timing belt
- Camshaft timing/engine timing
- Crankshaft Positioning

## Engine Timing Tool RENAULT

Contents:

3888-16 17 18 19 (2x) 20 21 76

HAZET No.	EAN-No. 4000896+
3888/8	155699
Camshaft Plate Bracket	
3888-16	155705
Camshaft Sprocket Holding Tool	
3888-17	155712
6-Point Threaded Nut	
3888-18	155729
Gear Arm	
3888-19	155835
Belt Guide Pulley Wrench	
3888-20	155842
Camshaft Sprocket Holding Tool	
3888-21	155859
Adapter	
3888-76	155866

## Universal Engine Timing Tool Set



### For the professional engine repair

#### E.g. for timing belt changing

- Suitable for single and twin camshaft petrol and diesel engines
- For locking the injection pump sprocket and retaining the camshaft timing
- The use of this locking tool ensures that the camshaft sprockets/injection pump sprockets are locked in their correct positions and crankshaft timing is retained during timing belt replacement or other engine repair
- Detailed operating instructions
- Single parts optionally available
- Clear arrangement in high-quality plastic case with soft foam insert
- **Assortment of 5 pieces**

Contents:

4794-1 2 31 32 33

HAZET No.	EAN-No. 4000896+
4794/5	127764
Locking Device	
4794-1	137534
Extension Bridge Piece	
4794-2	137541
Basic appliance	
4794-31	137558
Locking Pin (short)	
4794-32	136872
Locking Pin (long)	
4794-33	136889

Engine

**Universal Engine Timing Tool Set**

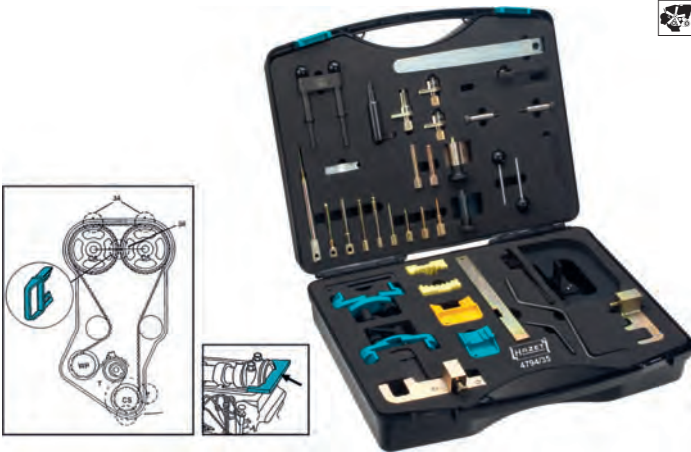

**For the professional engine repair**

- Locking pins and tools for timing belt changing, for crank shaft and camshaft locking for petrol and diesel engines on **VW, AUDI, SEAT, SKODA, FORD, OPEL, CITROEN, PEUGEOT, RENAULT**

Contents:

- 2587-1
- 2588-1 2 3 4 5 6 14 15 16 110
- 3088-15 16 19
- 3488-1 4 10 11
- 3788-1 3 4 5 7 9 10 24 28
- 3888-1 9 10 12
- 4794-1

HAZET No.	EAN-No. 4000896+
4794/35	160594
2587-1	053476
<b>Crankshaft Fixing Device</b> for locking the crankshaft, e.g. VW 1.6 l and 2.0 l Common-Rail diesel engine	087730
<b>2588-1</b>	087730
<b>Locking Plate</b> for locking the tensioner roller	087747
<b>2588-2</b>	087747
<b>Locking Pin</b> for locking the camshaft sprocket e.g. VW 1.6 l and 2.0 l Common-Rail diesel engine	087754
<b>2588-3</b>	087754
<b>Camshaft locking</b> for locking the camshaft sprockets when changing the timing belt	110391
<b>2588-4</b>	110391
Camshaft Setting Plate	137107
<b>2588-5</b>	137107
<b>2588-6</b>	137114
Fixing Bolt	144198
<b>2588-14</b>	144198
<b>2588-15</b>	144204
<b>2588-16</b>	144211
For 4-cyl. diesel/pump-nozzle injection engines since 2005 e.g. VW 2.0 l Common-Rail diesel engine Crankshaft Fixing Device For fixing the <b>oval</b> crankshaft timing belt pulley e.g. during timing belt replacement or engine repair	143283
<b>2588-110</b>	143283
Camshaft Setting Tool (yellow)	137190
<b>3088-15</b>	137190
Camshaft Setting Tool (blue)	137206
<b>3088-16</b>	137206
Camshaft Sprocket Locking Tool	155965
<b>3088-19</b>	155965
Camshaft Setting Plate	137084
<b>3488-1</b>	137084
Crankshaft TDC Location Pin	137497
<b>3488-4</b>	137497
Crankshaft Location Pin	136773
<b>3488-10</b>	136773
<b>3488-11</b>	136780
Crankshaft/Flywheel TDC Locking Pin	136643
<b>3788-1</b>	136643
<b>3788-3</b>	136667

**Universal Engine Timing Tool Set**

HAZET No.	EAN-No. 4000896+
Injection Pump Locking Pin	136506
<b>3788-4</b>	136506
Locking Pin/Bolt	136513
<b>3788-5</b>	136513
Camshaft Locking Bolt/ Pin	136537
<b>3788-7</b>	136537
Tensioner Setting Pin	136551
<b>3788-9</b>	136551
Special Wrench for Tensioner Roller	136964
<b>3788-10</b>	136964
Crankshaft/Flywheel TDC Locking Pin	136957
<b>3788-24</b>	136957
Locking Pin	136940
<b>3788-28</b>	136940
Crankshaft TDC Locking Pin	136575
<b>3888-1</b>	136575
Camshaft Setting Plate (Exhaust)	137275
<b>3888-9</b>	137275
Camshaft Setting Plate (Inlet)	137282
<b>3888-10</b>	137282
Camshaft Setting Plate	137305
<b>3888-12</b>	137305
Locking Device	137534
<b>4794-1</b>	137534

**Universal Engine Timing Tool Set**

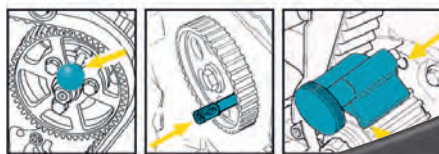
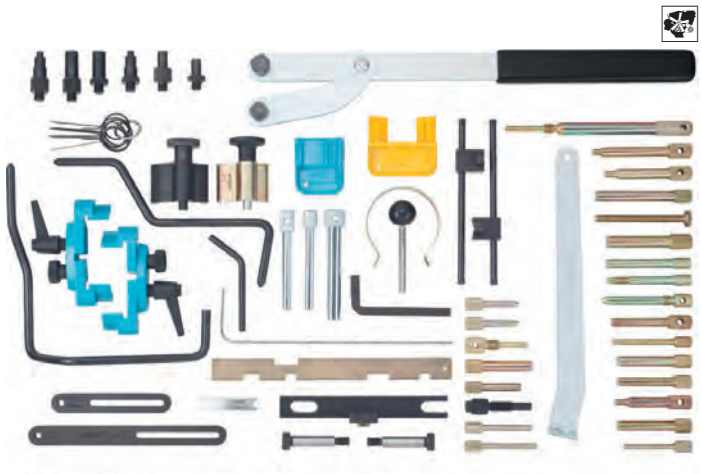





## Universal Engine Timing Tool Set

### For the professional engine repair

- For timing belt changing and other engine repairs

For the professional engine repair on e.g.:

**VW/AUDI, SKODA, OPEL, ALFA/FIAT, MAZDA, FORD, VOLVO, PEUGEOT, CITROËN, TOYOTA, MITSUBISHI, HONDA, NISSAN** etc.

48 pieces, in plastic case with soft foam insert

Contents:

2540-2  
2587  
2588-1 2 3 6 110  
3088-15 16  
3488-2 3 4 10 11 13 15 18 19  
3788-1 2 3 4 8 6 7 9 11  
17 18 19 20 21 22 23 24 25  
27 28 29 30 31 33 34 35 36  
4788-1/6  
4794-1 2

HAZET No.	EAN-No. 4000896+
<b>4794/48</b>	166176
Retainer	
<b>2540-2</b>	166190
<b>2587</b>	017140
<b>Crankshaft Fixing Device</b> for locking the crankshaft, e.g. VW 1.6 l and 2.0 l Common-Rail diesel engine	
<b>2588-1</b>	087730
<b>Locking Plate</b> for locking the tensioner roller	
<b>2588-2</b>	087747
<b>Locking Pin</b> for locking the camshaft sprocket e.g. VW 1.6 l and 2.0 l Common-Rail diesel engine	
<b>2588-3</b>	087754
Camshaft Setting Plate	
<b>2588-6</b>	137114
For 4-cyl. diesel/pump-nozzle injection engines since 2005 e.g. VW 2.0 l Common-Rail diesel engine	
Crankshaft Fixing Device For fixing the <b>oval</b> crankshaft timing belt pulley e.g. during timing belt replacement or engine repair	
<b>2588-110</b>	143283
Camshaft Setting Tool (yellow)	
<b>3088-15</b>	137190
Camshaft Setting Tool (blue)	
<b>3088-16</b>	137206
Locking Pin	
<b>3488-2</b>	136797
<b>3488-3</b>	136803
Crankshaft TDC Location Pin	
<b>3488-4</b>	137497
Crankshaft Location Pin	
<b>3488-10</b>	136773
<b>3488-11</b>	136780
Camshaft Setting Plate	
<b>3488-13</b>	155880
Crankshaft Locking Tool	
<b>3488-15</b>	155910
Locking Pin	
<b>3488-18</b>	166206
<b>3488-19</b>	166213
Crankshaft/Flywheel TDC Locking Pin	
<b>3788-1</b>	136643
<b>3788-2</b>	136650
<b>3788-3</b>	136667
Injection Pump Locking Pin	
<b>3788-4</b>	136506
Locking Pin/Bolt	
<b>3788-5</b>	136513
Injection Pump Locking Bolt/Pin	
<b>3788-6</b>	136520
Camshaft Locking Bolt/Pin	
<b>3788-7</b>	136537
Tensioner Setting Pin	
<b>3788-9</b>	136551

## Universal Engine Timing Tool Set

HAZET No.	EAN-No. 4000896+
Special Wrench for Tensioner Roller	
<b>3788-11</b>	136971
Locking Bolt	
<b>3788-17</b>	137169
Balancer Shaft Belt Tensioner Adjuster	
<b>3788-18</b>	136988
<b>3788-19</b>	136995
Timing Belt Retaining Clip	
<b>3788-20</b>	137176
Injection Pump and Crankshaft Locking Pin	
<b>3788-21</b>	136858
Flywheel Locking Tool	
<b>3788-22</b>	136865
Camshaft Locking Pin	
<b>3788-23</b>	136766
Crankshaft/Flywheel TDC Locking Pin	
<b>3788-24</b>	136957
Locking Pin	
<b>3788-25</b>	136919
<b>3788-27</b>	136933
<b>3788-28</b>	136940
Camshaft Locking Pin	
<b>3788-29</b>	136568
<b>3788-30</b>	136674
Crankshaft Locking Tool	
<b>3788-31</b>	136681
Camshaft Locking Pin	
<b>3788-33</b>	136698
Setting Pin	
<b>3788-34</b>	166220
<b>3788-35</b>	166237
<b>3788-36</b>	166244
Locking Pin Set	
<b>4788-1/6</b>	166183
Locking Device	
<b>4794-1</b>	137534
Extension Bridge Piece	
<b>4794-2</b>	137541

## Assembly Lever for V-Ribbed Belt



- For the operation of the **tensioner roller** and for installing the **V-ribbed belt** on **MERCEDES-BENZ** type 168, 169 (A-Class), 245 (B-Class)
- Surface: chrome-plated, bold burnished

**Made in Germany**

HAZET No.	l mm	S mm	EAN-No. 4000896+
<b>2714-1</b>	600	15	076789

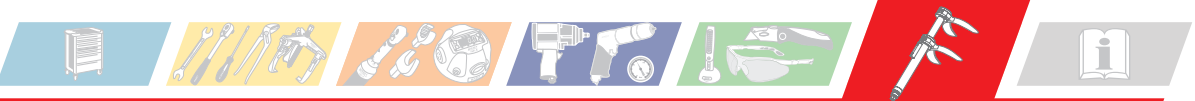

**Spark- and Glow Plug**

**Overview Spark and Glow Plugs**

HAZET No.	mm	"	l mm	□
880 Lg-20,8	20,8	13/16	70	10 3/8
880 TZ-20,8	20,8	13/16	70	10 3/8
880 MgT	20,8	13/16	64	10 3/8
880 A MgT	16	5/8	64	10 3/8
880 MgT-18	18	–	62	10 3/8
880 A MgT-1	16	5/8	64	10 3/8
880 A Mgt-3	17,5	11/16	64	10 3/8
880 KF	20,8	13/16	64	10 3/8
880 A KF	16	5/8	64	10 3/8
900 Lg-20,8	20,8	13/16	85	12 1/2
900 TZ-20,8	20,8	13/16	85	12 1/2
900 MgT	20,8	13/16	68	12 1/2
900 A MgT	16	5/8	71	12 1/2
900 KF	20,8	13/16	71	12 1/2
900 A KF	16	5/8	71	12 1/2
2505-2	20,8	13/16	137,5	10 3/8
2530 (G)	10	–	140	10 3/8
4760-1 (G)	12	–	152	10 3/8
4760-2 (G)	8	–	142	10 3/8
4760-3 (G)	9	–	142	10 3/8
4766	16	5/8	97	10 3/8
4766-1	16	5/8	270	10 3/8
4766-2	14	–	64	10 3/8
4767 A KF	16	5/8	480	12 1/2

(G) = Glow Plug

**Spark Plug Socket Pliers**



- For installing and removing **spark plug sockets**
- Especially suitable for **hot terminals**
- With side cutter
- Ergonomically shaped **2-component plastic handle covers**
- Surface: chrome-plated

HAZET No.	l mm	EAN-No. 4000896+
1849	195	007080



- For installing and removing straight **spark plug sockets**
- Safe application due to milled jaw profile
- Especially on **MERCEDES-BENZ**
- Ergonomically shaped **2-component plastic handle covers**
- Surface: chrome-plated

HAZET No.	l mm	EAN-No. 4000896+
1849-1	200	128037

**Spark Plug Socket Pliers**



- For installing and removing straight **spark plug sockets**
- **Long jaws** provide a better safety distance to the hot engine
- Especially for **deeply located spark plug sockets**, e.g. on **AUDI V6** and **V8** engines, **JAGUAR 12 cyl.**
- Ergonomically shaped **2-component plastic handle covers**
- Surface: chrome-plated

HAZET No.	l mm	EAN-No. 4000896+
1849-2	290	007103



- For installing and removing **spark plug sockets**
- Especially suitable for **hot terminals**
- Long style
- Ergonomically shaped **2-component plastic handle covers**
- Surface: chrome-plated

HAZET No.	l mm	EAN-No. 4000896+
1849-3	265	055098

**Spark Plug Socket Remover**



- For installing and removing **spark plug sockets** even on hot engines
- For 2.8-2.9 l VR6-engine **VW-Golf**, **Passat**, **Vento**, **Corrado**, **T5 2.0 l**, **Lupo 4-cyl.** since 1999, **AUDI 80**, **100**, **A4**, **A6** with 2.6- and 2.8 l V6-engines
- Slotted tube for optimal and careful guidance of the cable

HAZET No.	l mm	EAN-No. 4000896+
1849-6	253	007110



- For installing and removing spark plug sockets even on hot engines**
- **Now also for VW-Golf 4, 5, 6-1.6 l, Polo 5-1.2 l since 2009**, **Bora** since 1999 and **Touran** since 2004 with 1.6 l, 4 cyl. injection engine with roller cam follower, **New Beetle** since 1999 with 2.0 l, 4 cyl. injection engine and 2 valve 4 cyl. injection engine with roller cam follower
  - **AUDI A3** since 2004 with 2 valve 4 cyl. injection engine
  - **SEAT, SKODA** and **SMART For Two** (type 450)

**Spark Plug Socket Remover**

- With T-handle

HAZET No.	l mm	EAN-No. 4000896+
1849-9	275	110476

**Ignition Coil Remover**



- For installing and removing ignition coils with final output stage on **VW Polo**, **Fox 1.2 l**, **Golf 1.4**, **1.6 l**, **Golf Plus 1.4 l** since 2005, **Caddy 1.4 l**, **Bora 1.4**, **1.6 l**, **Beetle 1.4 l** (petrol engine since 2003), **Scirocco 1.4 l** since 2009, **Lupo 4 cyl.** direct injection engine since 1999, **Passat**, **Touran 1.6 l**, **Phaeton**, **Transporter T4**, **SKODA Fabia**
- With T-handle
- Surface: chrome-plated

HAZET No.	l mm	EAN-No. 4000896+
1849-7	135	110353



- For installing and removing ignition coils with final output stage on **VW Golf**, **Bora**, **Eos 3.2 l** since 2006, **Passat**, **Sharan**, **Touareg 6-cyl.** since 2003, **Transporter T5 3.2 l 6-cyl.** injection engine since 2004
- **AUDI TT 3.2 l** model years 1999-2007, **A3 3.2 l** since 2004
- With T-handle
- Surface: chrome-plated

HAZET No.	l mm	EAN-No. 4000896+
1849-8	133	110360





## Specialty Tools – Engine – Spark- and Glow Plug

### Ignition Coil Remover

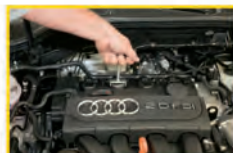

- For installing and removing ignition coils with final output stage
- **VW** direct injection engines 2.0: Golf (since 2004), Touran (since 2004), Passat (since 2006), Eos (since 2006), Polo (since 2002) 4 cyl. 5V, Scirocco (since 2009) 1.8 and 2.0 l, Tiguan (since 2006) 1.8 and 2.0 l, Phaeton (since 2003) 8 cyl.
- **AUDI** direct injection engines: A3 (since 2004) 2.0, A4 (since 2002) 2.0, A5 (since 2008) 3.2 and 4.2 l, A6 (since 2005) 3.2, A8 (since 2003) 3.2–4.2 and 5.2 l, TT (since 2007) 1.8 and 2.0 l, R8 (since 2008) 4.2 l, Q5 (since 2008) 2.0 and 3.2 l, Q7 (since 2007) 3.6 and 4.2 l
- With T-handle
- Surface: chrome-plated

**Made in Germany**

HAZET No.	l mm	EAN-No. 4000896+
1849-10	102	132201

### Spark Plug Wrench



- For spark plugs with 20.8/13/16" wrench size
- With rubber ply
- Adjustable in length from 137.5 mm to 157.5 and 197.5 mm
- drive 10 = 3/8"
- Surface: chrome-plated

**Made in Germany**

HAZET No.	S"	l mm	S mm	EAN-No. 4000896+
2505-2	13/16	197.5	20.8	016266

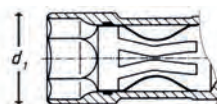

### Spark Plug Wrench

- For 16 mm (5/8") spark plugs (C-plugs), e.g. on motorcycles **BMW** C1, **KAWASAKI**, **YAMAHA**, **HONDA**, **SUZUKI**, **DUCATI**, as well as **MERCEDES-BENZ** passenger cars e.g. A-Class (type 168, 169), B-Class (type 245)
- With ball joint
- With fixing clamp for a firm hold of the spark plug
- Short style
- drive 10 = 3/8"
- Surface: chrome-plated

**Made in Germany**

HAZET No.	d <sub>1</sub> mm	d <sub>2</sub> mm	S"	l mm	S mm	EAN-No. 4000896+
4766	21.4	18	5/8	97	16	049295



- For 16 mm (5/8") spark plugs, e.g. on **VW** engine VR6, Golf 1.4–1.6–2.0 l since 2004, Golf Plus since 2005, Lupo 4 cyl. since 1999, Polo 3 cyl. since 2002, **AUDI**, **SKODA** Octavia, Fabia, **RENAULT** V6 and V8, **FORD**, **OPEL**, **BMW**, **NISSAN**, **HONDA**, **ROVER** 213 and 800, **MAZDA** 626 and 323F, **MITSUBISHI** GDI
- With ball joint
- With fixing clamp for a firm hold of the spark plugs
- drive 10 = 3/8"
- Surface: chrome-plated

**Made in Germany**

HAZET No.	d <sub>1</sub> mm	d <sub>2</sub> mm	S"	l mm	S mm	EAN-No. 4000896+
4766-1	21.4	18	5/8	270	16	048991

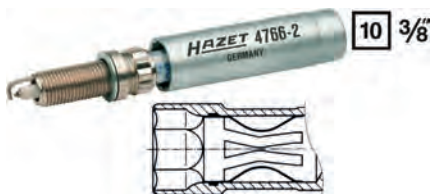

- For 14 mm spark plugs
- With fixing clamp for a firm hold of the spark plug
- 12-Point profile enables application of 14 mm spark plugs with 6-Point and 12-Point
- Application on **BMW** E 90 N 54 engine, 335 i limousine since 2006, **RENAULT** Modus, Twingo, Clio, Kangoo with 1.2 l 16 V engine, **PEUGEOT** 207, 307, **CITROËN** C4 with 1.4 and 1.6 l 16 V engine, C5 with 2.0 HPI engine as well as on **MERCEDES-BENZ** engine M 156, engine M 276, **NISSAN** Micra, Note, **MINI** 1.2–1.4 l 4-cyl. since 2007

**Made in Germany**

HAZET No.	d <sub>1</sub> mm	d <sub>2</sub> mm	l mm	S mm	EAN-No. 4000896+
4766-2	18	17.3	64	14	087655



- With spring in the joint
- With fixing clamp for a firm hold of the spark plugs
- drive 12.5 = 1/2"
- Surface: chrome-plated

**Made in Germany**

### Spark Plug Wrench

- For 16 mm (5/8") spark plugs
- With three outside guide collars

4767 A KF 5/8 480 16 049028

### Spark Plug Brush



- For cleaning of electrodes and contacts on spark plugs
- Special corrugated brass wire bristles
- 3 rows
- Trim size: 15 mm
- Wooden body

**Made in Germany**

HAZET No.	l mm	EAN-No. 4000896+
2131	150	012541

### Glow Plug Socket



- For 10 mm glow plugs
- drive 10 = 3/8"
- With universal joint
- With ball clamping
- Application: **VW**, **AUDI** diesel direct injection engines TDI and **MERCEDES-BENZ** CDI, **SMART**
- Surface: chrome-plated

**Made in Germany**

HAZET No.	l mm	S mm	EAN-No. 4000896+
2530	140	10	016341

### Glow Plug Wrench



- For 12 mm glow plugs, e.g. on **MERCEDES-BENZ** 201 and 202 with 4 valve technique as well as on **OPEL**, **BMW** and **FORD** diesel engines
- With ball clamping to hold the glow plug
- Universal joint providing an optimal pivoting angle
- drive 10 = 3/8"
- Surface: chrome-plated

**Made in Germany**

HAZET No.	l mm	S mm	EAN-No. 4000896+
4760-1	152	12	022229

**Glow Plug Wrench**



- For 8 mm glow plugs, e.g. on MERCEDES-BENZ, SMART, VW, FIAT and OPEL with diesel engines
- With ball clamping to hold the glow plug
- Universal joint providing an optimal pivoting angle
- □ drive 10 = 3/8"
- Surface: chrome-plated
- **Made in Germany**

HAZET No.	S mm	l mm	S mm	EAN-No. 4000896+
4760-2	5/16	142	8	118670

**Glow Plug Wrench**

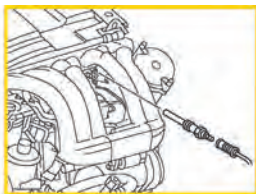

- For 9 mm glow plugs, e.g. on OPEL, FIAT, ALFA, LANCIA diesel engines
- With ball clamping to hold the glow plug
- Universal joint providing an optimal pivoting angle
- □ drive 10 = 3/8"
- Surface: chrome-plated
- **Made in Germany**

HAZET No.	l mm	S mm	EAN-No. 4000896+
4760-3	142	9	127849

**Glow Plug Socket Pliers**



- For installing and removing glow plug sockets
- For the new generation of diesel engines, e.g. MERCEDES-BENZ, VW, AUDI, SEAT, SKODA and BMW
- Offset design for the use on glow plug sockets in areas with restricted access
- The pliers' design is especially adapted to the sockets
- With recess preventing cable damage
- Ergonomically shaped 2-component plastic handle covers
- **Made in Germany**

HAZET No.	EAN-No. 4000896+
4760-5	089130



**Application**

www.hazet.de → Online-Katalog  
→ Zuordnung Glühkerzen-Reibahlen zu Fahrzeugtypen  
◀ For Smartphones with QR-Reader (App)

**Glow Plug Reamer**

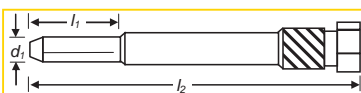
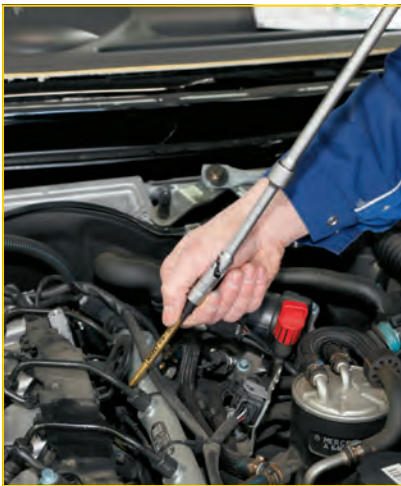

**For professional glow plug shaft cleaning in the cylinder head**

- Before refitting new glow plugs, it is advisable to clean the glow plug shafts
- Trouble-free removal of deposits and coking in the glow plug shaft
- With TIN coating

Classification to vehicles: www.hazet.de  
• **Made in Germany**

HAZET No.	l1 mm	l2 mm	Ø mm	mm	EAN-No. 4000896+
Set of 3 pieces: 4798-1	2	3			
4798/3	-	-	-	-	153237

**CHRYSLER, JEEP, MERCEDES-BENZ**  
4798-1 27.5 107.5 5.7 M 10 x 1 151301

**ALFA, AUDI, BMW, CITROËN, FIAT, FORD, JEEP, LAND ROVER, MERCEDES BENZ, NISSAN, OPEL, PEUGEOT, RENAULT, ROVER, SEAT, VOLVO, VW**  
4798-2 24 56 6.9 M 12 x 1.25 151318

**MERCEDES-BENZ**  
4798-3 27 94.5 6.9 M 12 x 1.25 151325

For TOYOTA Yaris, Yaris Verso, Corolla and Auris with 1.4D-4D diesel engine Drive size 10 mm

4798-4	34	103.5	4.4	M 10 x 1.25	167340
--------	----	-------	-----	-------------	--------

**Cylinder Head**

**Cylinder Head Screwdriver Socket**

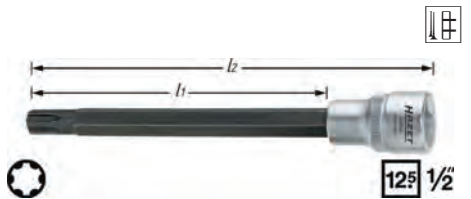

- For the operation of Polydrive-cylinder head bolts on VW engines (VW, AUDI, SEAT, SKODA)
- □ drive 12.5 = 1/2"
- **Made in Germany**

HAZET No.	l1 mm	l2 mm	EAN-No. 4000896+
2579-9	130	168	086931

**Screwdriver Socket**



- For screws on cylinder head and cardan shafts screws with internal serration XZN
- □ drive 12.5 = 1/2"
- **Made in Germany**

HAZET No.	l1 mm	l2 mm	M	EAN-No. 4000896+
2751	100	140	10	017508

**TORX® Cylinder Head Tool**



For the operation of cylinder head bolts

- **TORX®** Impact Socket
- Suitable for impact wrenches
- □ drive 20 = 3/4"
- Reinforced design
- Surface: phosphated
- **Made in Germany**

HAZET No.	mm	l mm	EAN-No. 4000896+
-----------	----	------	------------------

On MAN commercial vehicles M 2000 and MAN busses with D 08 engines

2850-E 18 16.70 110 086412

On MAN commercial vehicles F 2000, F 90, F 8 and MAN busses with D 25 and D 28 engines

2850-E 20 18.49 110 079681

On MAN commercial vehicles with Common Rail engine (D20)

2850-E 24 22.16 110 146758





## Specialty Tools – Engine – Valve / Piston

### Valve / Piston

#### Compressed Air Adapter



- For keeping installed valves lifted when installing and removing the cylinder head valve keys
- On **FORD** engines except CVH engines and multi-valve engines
- Spark plug threads M 14 x 1.25 and M 18 x 1.5
- Compressed-air supply 13 mm 6-point

Made in Germany

HAZET No.	l mm	EAN-No. 4000896+
3428	140	018819

#### Piston Ring Compressor



- With square key for tensioning
- May be locked continuously
- High-strength spring band steel

Made in Germany

HAZET No.	∅ mm	h mm	EAN-No. 4000896+
794-01	40–75	50	031597
794-1	60–125	80	031610
794-2	90–175	80	031641
794-3	90–175	165	031665

#### Piston Ring Pliers



- For compression of piston rings on water- and air-cooled engines
- Tightening band (width 32 mm), can easily be released
- Surface: chrome-plated

Made in Germany

HAZET No.	∅ mm	l mm	EAN-No. 4000896+
794 U-3	70–100	332	031672

#### Piston Ring Pliers



- For installing and removing piston rings
- Surface: bright nickel-plated

Made in Germany

HAZET No.	∅ mm	l mm	EAN-No. 4000896+
790-1	50–100	220	031412
790-1 a	65–110	240	031429
790-2	110–150	280	031443



- With prism holder for safe grip of various piston ring types
- Surface: nickel-plated, prism holder burnished

Made in Germany

HAZET No.	∅ mm	l mm	EAN-No. 4000896+
790-3	60–120	220	031450

#### Valve Refacer



- With suction cup

Made in Germany

HAZET No.	∅ mm	EAN-No. 4000896+
795-1	20	031771
795-2	25	031788
795-3	30	031795
795-4	37	031801

#### Valve Spring Compressors

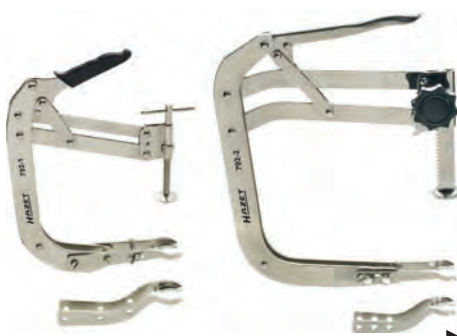

#### Valve Spring Compressors



- With 1 pair of straight and bent jaws each, 792-1 with straight jaws sb 75–225 with bent jaws sb 45–195 792-2 with straight jaws sb 120–280 with bent jaws sb 90–250

- Surface: bright nickel-plated

Made in Germany

HAZET No.	l mm	EAN-No. 4000896+
792-1	290	031481
792-2	380	031511

#### Valve Stem Seal Ring Pliers



- For removing valve stem seals on 2-valve engines
- On **VW/AUDI, FORD, OPEL, NISSAN**, etc.
- Serrated
- Hardened jaws

- Surface: nickel-plated, jaws burnished

Made in Germany

HAZET No.	l mm	EAN-No. 4000896+
791-5	250	031467



- For easy and reliable removing of deeply located valve stem seals due to the extra long jaws

- For multi-valve engines, e.g. on **OPEL, VW and FORD**

- Dip-coated jaws
- Jaws hardened, serrated
- Straight

- Surface: nickel-plated

Made in Germany

HAZET No.	l mm	EAN-No. 4000896+
791-8	270	061068



- For removing valve stem seals especially on **BMW** multi-valve engines since 1990, **OPEL**-Omega B, 2.5 Turbo-diesel, **FORD**-Fiesta since 1996

- Jaws hardened, longitudinally toothed
- Working area dip-insulated avoiding damage to the valve timing

Made in Germany

HAZET No.	l mm	EAN-No. 4000896+
2991	250	018352

**Fuel System / Injection Technology**

**Turbo Charger Wrench**



**Operation of the turbo charger nuts on MAN commercial vehicles**

- Bent form of the box wrench is especially adapted to the confined spaces
  - Ergonomically shaped 2-component handle
- Made in Germany**

HAZET No.	l mm	S mm	EAN-No. 4000896+
2849-15	266	15	159284

**Ball-Head Screwdriver Socket**



- For knock sensor on V6 engine  
**AUDI** 100 since 12/1990  
**AUDI** 80 since 7/1992
  - □ drive 12.5 = 1/2"
  - For **inside hexagon screws**
  - Blades made of special steel
- Made in Germany**

HAZET No.	d mm	l <sub>1</sub> mm	l <sub>2</sub> mm	S mm	EAN-No. 4000896+
2527-8	23	200	238	8	016310

**Injection Line Wrench**

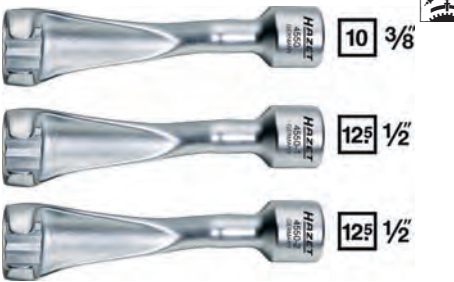

- Open 12-Point Socket for the operation of screwed connections on injection lines
  - Surface: chrome-plated
- Made in Germany**

HAZET No.	l mm	S mm	EAN-No. 4000896+
4550	115	17	021680

□ drive 10 = 3/8"  
for **BMW** diesel engines and **OPEL** 2.5 TD engines

- For injection lines on **MERCEDES-BENZ** 100, 130, 314, 360, 360h, 352A, 346/355, 401, 402, 403, 407h, 615, 616, 617
  - **Long style**
  - □ drive 12.5 = 1/2"
- |        |     |    |        |
|--------|-----|----|--------|
| 4550-1 | 120 | 17 | 021697 |
|--------|-----|----|--------|
- For injection lines on **MERCEDES-BENZ** M 352, A, 346/355, A, 401, 402/422, LA, 403, 407h, as well as for the dip stick guide tube on M 314
  - **Long style**
  - □ drive 12.5 = 1/2"
- |        |     |    |        |
|--------|-----|----|--------|
| 4550-2 | 119 | 19 | 021734 |
|--------|-----|----|--------|

**Injection Line Wrench**



- Open 12-Point Socket for the operation of screwed connections on injection lines
  - Surface: chrome-plated
- Made in Germany**

HAZET No.	l mm	S mm	EAN-No. 4000896+
4550-3	83	17	104307

- For the operation of screwed connections on injection lines of **MAN** commercial vehicles with D 20 engines – Common Rail injection systems
  - **Short style**
  - □ drive 10 = 3/8"
- |        |    |    |        |
|--------|----|----|--------|
| 4550-3 | 83 | 17 | 104307 |
|--------|----|----|--------|
- For the operation of screwed connections on injection lines of **MAN** commercial vehicles with D 20 engines – Common Rail injection systems
  - **Short style**
  - □ drive 10 = 3/8"
- |        |    |    |        |
|--------|----|----|--------|
| 4550-4 | 83 | 19 | 104291 |
|--------|----|----|--------|

**Injection Nozzle Socket**



- 6-Point Socket for **injection nozzles** on **MERCEDES-BENZ** diesel engines  
**MERCEDES-BENZ**-types 202 (C-Class) and 210 (E-Class) with 604, 605 and 606 engines
  - With side window
  - □ drive 12.5 = 1/2"
  - Surface: chrome-plated
- Made in Germany**

HAZET No.	l mm	S mm	EAN-No. 4000896+
4550-22	110	22	021741

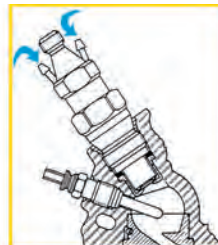

- 12-Point Socket for **injection nozzles** on diesel engines  
**VW**, **AUDI**, **MERCEDES-BENZ**, **OPEL**, **FORD**, **PEUGEOT**, **VOLVO**, **TOYOTA**, **MAZDA**, **NISSAN**, **MITSUBISHI**, **DAIHATSU**

**Injection Nozzle Socket**

- Special relief to accommodate the return leakage tubes
  - □ drive 12.5 = 1/2"
  - Surface: chrome-plated
- Made in Germany**

HAZET No.	l mm	S mm	EAN-No. 4000896+
4555 N	85	27	021840



- 12-Point Socket for **injection nozzles** on **BMW** diesel  
M21 = E30 = 324TD  
E28 = 524TD  
E34 = 524TD  
M51 = E36 = 325TD  
E34 = 525TDS,  
**FORD** diesel **LINCOLN** Continental (USA), **LINCOLN** Mark VII, VIILSC
  - □ drive 12.5 = 1/2"
  - Surface: chrome-plated
- Made in Germany**

HAZET No.	l mm	S mm	EAN-No. 4000896+
4555-1	85	27	021802



- 12-Point Socket for **injection nozzles** on **VW** Polo 1.3 I diesel engine,  
**NISSAN** Terrano TD 25, 27
  - With inside bore hole 22 mm Ø
  - □ 12.5 = 1/2"
  - Surface: chrome-plated
- Made in Germany**

HAZET No.	l mm	S mm	EAN-No. 4000896+
4555-3	82	22	021833

**Pressure Valve Holder Tool**



- Multipoint socket for installing and removing the **pressure valve holder** on the MRSF-ERE fuel injection pump, on **MERCEDES-BENZ** diesel passenger cars, 601, 602, 603, 605, 606, 615, 616, 617
  - With 33 teeth
  - □ drive 12.5 = 1/2"
  - Surface: chrome-plated
- Made in Germany**

HAZET No.	l mm	S mm	EAN-No. 4000896+
4556	55.5	17.9 x 20	021864





### Pressure Nut Crown Wrench



- For the operation of the pressure nut at the nozzle holder

**Made in Germany**

HAZET No.	l mm	FAN-No. 4000896+
4558	72	021888

- For commercial vehicles **MAN** and **MERCEDES-BENZ** M 401/421, M 402/422, LA, A, M 403/423, M 470h
- □ drive 12.5 = 1/2"

4558-1	120	050529
--------	-----	--------

- For commercial vehicles with EDC engines: **MERCEDES-BENZ** and **MAN**
- With hole bored through for connecting cable
- 32 mm outside hexagon drive
- For e.g. commercial vehicles **MERCEDES-BENZ** and **MAN**
- With retainer for fixation between pressure nut and nozzle holder – avoids slipping down
- 32 mm outside hexagon drive

4558-2	69	057344
--------	----	--------

### Injection Line Wrench



- For installing and removing the injection lines e.g. on **VW**, **AUDI** diesel engines: 1.6 l 4-cyl., 2.0 l 5-cyl., 2.4 l 6-cyl.

- Surface: chrome-plated

**Made in Germany**

HAZET No.	l mm	S mm	FAN-No. 4000896+
4560	221	17 x 17	021918

### Injection Pump Wrench



- Single Box-End Wrench for the fastening screws at the injection pump, when replacing the toothed belt or adjusting the injection start
- Application on 1.6 l 4-cyl. diesel engine **AUDI** 80, **VW** Golf, Jetta, Caddy, Passat, Santana, **CITROËN**
- Surface: chrome-plated

**Made in Germany**

HAZET No.	l mm	S mm	FAN-No. 4000896+
4561	165	13	021925

### Fuel Line Pliers



- For the operation of quick release fasteners at the fuel line and at the fuel tank aeration with slight pressure on **FIAT** / **ALFA** / **LANCIA** vehicles with 1.3 l – 1.9 l – 2.4 l diesel, **OPEL** (diesel engine) Vectra C / Signum 1.9 l diesel engine, Astra H 1.3 l and 1.9 l diesel engine, Corsa C / Combo / Meriva 1.3 l diesel engine **OPEL** (petrol) Corsa B, Astra F, G, Vectra B, Omega B petrol engine **CHRYSLER** Neon 1.8, Stratus 2.0 and 2.5, **RENAULT** passenger cars since 1997

**Made in Germany**

HAZET No.	l mm	FAN-No. 4000896+
4501-1	155	058624

### Flexible Hose Clamp



#### For clamping flexible hoses

- Firm fixation with clamp ring
- Made of high-quality plastic

HAZET No.	l mm	FAN-No. 4000896+
4590-1	150	021932

For heating and fuel hoses up to 15 mm Ø

4590-2	180	021949
--------	-----	--------

For hoses up to 30 mm Ø

4590-3	253	055753
--------	-----	--------

For e.g. cooling liquid hoses up to 60 mm Ø

### Flexible Hose Clamp Set

HAZET No.	FAN-No. 4000896+
4590/3	058266

- For clamping flexible hoses
- 3 pieces 4590-1 -2 -3

4590/3	058266
--------	--------

### Intake Pipe Screwdriver Socket



4797-5	174	176137
--------	-----	--------

### Intake Pipe Screwdriver Socket

- For inside hexagon screws
- □ drive 12.5 = 1/2"
- For intake pipe on **AUDI** 200

**Made in Germany**

HAZET No.	d mm	l <sub>1</sub> mm	l <sub>2</sub> mm	S mm	FAN-No. 4000896+
2584-1	23	210	248	6	017058

### Injector Extractor



- For removing seized or stuck common rail injectors without having to disassemble the cylinder head

**Made in Germany**

HAZET No.	l mm	FAN-No. 4000896+
4797/2	-	121205

- For e.g. **MERCEDES-BENZ** CD engines 611, 612, 613 etc.
- Especially suitable for the limited spaces due to the cylinder head cover

- Set of 2 pieces: 4797-1 2

4797-1	-	121175
--------	---	--------

#### Impact Extractor

M 16 x 1.5

#### Injector Claw

M 16 x 1.5

4797-1	-	121182
--------	---	--------

#### Injector Claw

M 16 x 1.5

4797-2	-	121182
--------	---	--------

- **External Adapter** with inside thread M16 x 1.5 on M27 x 1
- For the removal of **Bosch** injectors with outside thread M27 x 1
- In conjunction with Impact Extractor 4797-1
- The External Adapter must be used when the Injector Claw cannot be used, either because of the vehicle type or because of the lack of space. Note: Always replace the injector that has been removed with the External Adapter!

4797-3	50	121199
--------	----	--------

#### Injector Adapter

- With inside thread for the connection with Impact Extractor 4797-1
- External adapter for the injector removal on **VW** / **AUDI** 1.7SDI, 1.9TDI, 1.9SDI engines
- M 16 x 1.5 on M 14 x 1.5

4797-4	44	159444
--------	----	--------

For the simple removal of injectors with the aid of an impact extractor e.g. HAZET 4855-9 on **MAN** engines D08, D20, D26 and D28

- Especially suited to the limited spaces in the cylinder head
- Due to the tool's special claw, the injector may be seized with caution, damage-free removal with the aid of the impact extractor.
- Injector claw with inside thread M10 x 1.5 mm for easy insertion in the impact extractor

4797-5	174	176137
--------	-----	--------

**Cooling System /  
Hose Connection**

**Hose Clamp Pliers**



- For simple hose clamps, e.g. on washing machines
- Movable jaws
- Surface: chrome-plated

**Made in Germany**

HAZET No.	l mm	sb mm	EAN-No. 4000896+
798	206	40	031832



- For simple hose clamps
- With locking device
- Movable jaws
- Surface: chrome-plated

**Made in Germany**

HAZET No.	l mm	sb mm	EAN-No. 4000896+
798-1	285	45	031900

**Hose Clamp Pliers**



- For clamping multi-use **CLIC-type hose clamps** on fuel lines, e.g. on **VW, AUDI, OPEL, PEUGEOT and ALFA**
- Open and close easily by turning the pliers by 180°
- With fixed jaws, bent at 90°

**Made in Germany**

HAZET No.	l mm	sb mm	EAN-No. 4000896+
798-2	175	20	051397

**Hose Clamp Pliers**



For self-gripping spring band hose clamps

- **AUDI, VW, OPEL, PEUGEOT, SMART and MERCEDES-BENZ**
- Open and close easily by turning the pliers by 180°
- For clamping multi-use **CLIC-type hose clamps**
- **Movable jaws** – for use in areas with restricted access
- Surface: nickel-plated

**Made in Germany**

HAZET No.	l mm	sb mm	EAN-No. 4000896+
798-3	206	35	102433



- For spring band hose clamps
- Movable jaws

**Made in Germany**

HAZET No.	l mm	sb mm	EAN-No. 4000896+
798-4	205	35	031948



- For spring band hose clamps, e.g. on **VW, AUDI and OPEL**
- Movable jaws

**Made in Germany**

HAZET No.	l mm	sb mm	EAN-No. 4000896+
798-5	210	6-12	031955



- For spring band hose clamps **12 and 15 mm width**, 13–22 mm Ø
- Movable safety jaws

**Made in Germany**

HAZET No.	l mm	sb mm	EAN-No. 4000896+
798-6	235		031962

**Hose Clamp Tension Device**



- For self-gripping **spring band hose clamps** sb 8–52 mm Ø
- Enables working in areas with restricted access
- 6-point drive s 6 mm
- Easy working in conjunction with Reversible Ratchet 863 P, optionally with Flexible Extension 870 or 870-2 and 6-Point Socket 850-6 may also be used with Screwdriver for slotted screws (802 or 803) or Flexible Hex Nut-Driver 426-6
- Surface: galvanized

**Made in Germany**

HAZET No.	sb mm	EAN-No. 4000896+
798-7	8–52	083206

**Hose Clamp Pliers**



- For self-gripping spring band hose clamps **12 and 15 mm width**
- Self-adjusting joint allows easy working even on large hose clamps with large diameter
- With locking device
- Movable safety jaws
- Handles plastic coated

**Made in Germany**

HAZET No.	l mm	sb mm	EAN-No. 4000896+
798-8	290	45	076697



- Especially for spring band hose clamps **12 and 15 mm width**
- **Movable jaws**
- **Bent at 110°** – allowing application in areas with restricted access
- With locking device

**Made in Germany**

HAZET No.	l mm	sb mm	EAN-No. 4000896+
798-9	250	60	072163





### Hose Clamp Pliers



- For spring band hose clamps
  - Adjustable opening width
  - Fixed jaws
  - With locking device
  - Especially for **VW, AUDI**
- Made in Germany**

HAZET No.	l mm	sb mm	EAN-No. 4000896+
798-10	320	90	031917

### Hose Clamp Pliers



- For spring band hose clamps
  - Especially for **12 mm and 15 mm** spring band hose clamps, e.g. on **OPEL, VW, FORD, RENAULT, FIAT, PEUGEOT, CITROËN, PORSCHE, ALFA-ROMEO, MERCEDES-BENZ, SMART**
  - With locking device
  - Adjustable opening width
  - Handles plastic coated
- Made in Germany**

HAZET No.	l mm	sb mm	EAN-No. 4000896+
798-12	320	80	031931

### Hose Clamp Pliers



#### With movable jaws

- Enables working in areas with restricted access
  - For the operation of spring band hose clamps whose three ends fit tightly on the hose, e.g. on tank ventilation lines and fuel lines on **VW, AUDI, SEAT** and **SKODA**
- Made in Germany**

HAZET No.	l mm	sb mm	EAN-No. 4000896+
798-13	192	27	155248

### Hose Clamp Pliers



- For the operation of spring band hose clamps whose three ends fit tightly on the hose, e.g. on fuel lines and tank ventilation lines on **VW, AUDI, SEAT, SKODA**
  - Surface: nickel-plated
- Made in Germany**

HAZET No.	l mm	sb mm	EAN-No. 4000896+
798-14	177	8-18	109128

### Hose Clamp Pliers



- For the operation of self-gripping spring band hose clamps  $sb\ 7 - 60\text{mm } \varnothing$
  - **Bowden cable** (610 mm) enables application in areas with restricted access where the application of usual hose clamp pliers is not possible
  - With **toothed fixing device**
  - Newly developed slide device with integrated tension spring and adjustable reversible plate
  - Application on cooling and heating circuits
  - Handles with plastic coating for better gripping comfort
- Made in Germany**

HAZET No.	l mm	sb mm	EAN-No. 4000896+
798-15 A	875	7-60	097258

**Bowden cable for 798-15 A**  
complete: bowden cable, coating, 2 headless screws, spring

798-0151 A - - 097753

Bowden cable for 798-15 A and B

798-0152 A - - 097760

Sliding guide device for 798-15 A and B

798-0153 A - - 097784



**Seafarers put their trust in sea rescuers – sea rescuers put their trust in HAZET Quality Tools!**



## Hose Clamp Pliers

(E)



### New design with plastic coated semiflexible Bowden cable

- The Bowden cable allows working without a guiding hand
- For the operation of self-gripping spring band hose clamps on cooling and heating circuits
- Slide device with integrated tension spring and adjustable reversible plate
- Automatic toothed fixing device
- Especially appropriate for areas with restricted access where the application of usual pliers is not possible
- Handles with plastic coating for better gripping comfort

Made in Germany

HAZET No.	l mm	sb mm	EAN-No. 4000896+
798-15 B	875	7–60	117727
Flexible hose for 798-15 B			
798-0150 B	-	-	142439
Bowden cable for 798-15 A and B			
798-0152 A	-	-	097760
Sliding guide device for 798-15 A and B			
798-0153 A	-	-	097784



### With reinforced Bowden cable and slide device

- Especially suitable for hose clamp with parallel clamp ends, e.g. at the charge-air cooler connection on VW Passat or T5
- Bowden cable enables application in areas with restricted access
- Handles with plastic coating for better gripping comfort, with toothed fixing device and one-hand operation
- Fixing device is released by pressure lever

## Hose Clamp Pliers

(E)

Made in Germany

HAZET No.	l mm	sb mm	EAN-No. 4000896+
798-16	875	3–50	149032
Bowden cable for 798-16			
798-0162	-	-	149056
Sliding guide device for 798-16			
798-0163	-	-	149063

## Vacuum-Type Cooling System Filler



Suitable in conjunction with the single and universal adapters of the HAZET range of Cooling System Testers 4800 or with an appropriate rubber cone of the set 4801-2/3

- Vacuum leakage test before refilling the cooling system
- Bubble-free refilling
- Easy application due to quick-release coupling
- Time-saving, no additional bleeding necessary
- Application possible on almost all types of vehicles
- In plastic case including application note

Made in Germany

HAZET No.	EAN-No. 4000896+
4801-1	148806

## Cone Set for Radiator Expansion Tank

Ø 34-50 mm  
Ø 24-39 mm  
Ø 17-31 mm



Universal set suitable for radiator/expansion tank

- Application in conjunction with Vacuum-Type Cooling System Filler HAZET 4801-1
- Due to the vacuum generated in the cooling system the rubber cone is stuck firmly in the radiator or expansion tank opening

Set of 3 pieces:

3 rubber cones with functional Ø 17-31 / 24-39 / 34-50mm

Made in Germany

HAZET No.	EAN-No. 4000896+
4801-2/3	152407

## Diagnostics



### Application

Adapter for Cooling System  
www.hazet.de → Online-Katalog  
→ Zuordnung Kühleradapter 4800  
◀ For Smartphones with QR-Reader (App)

## Tester for Cooling System



For testing cooling systems

- By building up pressure with Cooling Pump HAZET 4800-1, it is possible to test the cooling systems of various vehicle types
- Classification to vehicles:  
<http://www.hazet.de/produkte/produktanwendungen/kuehleradapter/>

Contents:

1 Cooling Pump 4800-1  
up to 2.5 bar with in-line quick coupling

1 Intermediary Hose 4800-2  
Flexible Hose

5 Adapters for Cooling System  
4800-4 A 6 A 12 A 15 17

Made in Germany

HAZET No.	EAN-No. 4000896+
-----------	------------------

Application on AUDI A2, A3, A4, A5, A6, A7, A8, TT, VW Passat, Golf 3, 4, 5, Lupo (since 1998), Vento (since 1997), Jetta, EOS, Bora, T5, CITROËN C2, C3, C4, C5, C6, C8, Jumper, Jumpy, FIAT Tipo, Tempra, MERCEDES-BENZ type 202/203 (C-Class), 124/210 (E-Class), 129/220 (S-Class), 251 (R-Class), 164 (M-Class), NISSAN Micra, OPEL Vectra C, Astra H, Zafira A, Meriva, Signum, Corsa, PEUGEOT, RENAULT Safrane, Megane, Laguna, Twingo, Trafic, Master, SEAT Arosa, Córdoba, Ibiza (since 1999), Toledo (since 1998), Vario and León (until 1998), SKODA Octavia (until 1998), Fabia (since 1998), Roomster

Set of 7 pieces in plastic case

4800/7 132874

Case, empty, with insert for 4800/9

4800/9 KL 049820







## Tester for Cooling System

### For testing cooling systems

- By building up pressure with Cooling Pump HAZET 4800-1, it is possible to test the cooling systems of various vehicle types
- Classification to vehicles:  
<http://www.hazet.de/produkte/produktanwendungen/kuhleradapter/>

### Contents:

- 1 Cooling Pump 4800-1 up to 2.5 bar with in-line quick coupling
- 1 Intermediary Hose 4800-2 (flexible hose)
- 11 Adapters for Cooling System 4800-3 4 A 5 A 6 A 7 A 8 A 12 A 13 A 17 22 23

HAZET No.	FAN-No. 4000896+
4800/12	165483

## Cooling Pump



### Components

Made in Germany

HAZET No.	FAN-No. 4000896+
-----------	------------------

### COMPONENTS:

#### Cooling Pump

with in-line quick coupling up to 2.5 bar

4800-1 022243

#### Intermediary Hose, flexible

4800-2 022274

Adapter for Radiator STANDARD, e.g. MERCEDES-BENZ-Vito, Viano, PORSCHE, FIAT, KIA, MITSUBISHI, SUZUKI Vitara, Samurai

4800-3 022281

Also suitable as connector for HAZET adapters for Cooling System without coupling fitting Now for even more car models (replaces adapter 4800-4)

ALFA ROMEO 147, 164, 166, GT, Mito CITROËN C2, C3, C4, C5, C6, C8, Jumper, Jumpy DACIA Logan, Sandero FERRARI threaded port FIAT 500 since 2009, Bravo, Doblo, Fiorino, Grande Punto, Idea, Linea, Multipla, Panda, Punto, Qubo, Scudo, Seicento, Tempira, Tipo, Ulysse FORD Ka since 2009 MINI Mini since 2008 MITSUBISHI Carisma D since 2003, Space Star D NISSAN Micra PEUGEOT 206 until 1999, 207, 307 since 2004, 308, 406 until 1999, 807 since 2004, Expert, Partner LAND ROVER Freelander 2,0 DI LANCIA Delta, Musa, Phedra, Thesis MASERATI threaded port RENAULT Avantime, Espace, Master, Mégane, Laguna, Safrane, Trafic, Twingo ROVER 200/400 RT-RS VOLVO 850, 960, C 70 until 2007, S 40 until 2003, S 60 until 2007, S 80 until 2007, V 40 until 2003, V 70 until 2007, XC 90 until 2007

4800-4 A 156504

## Cooling Pump

HAZET No.	FAN-No. 4000896+
-----------	------------------

VW-Golf 2, Transporter T3, AUDI, PORSCHE 986, 987, 996, 997, Cayman, Carrera GT, SMART For Two, Roadster

4800-5 A 161843

VW-Passat, Golf 3, T4, Lupo since 1998 SEAT Arosa, Cordoba, Ibiza since 1999, SEAT Vario and León until 1998, SKODA Octavia until 1998

4800-6 A 161850

OPEL Corsa B, Frontera, Calibra, Agila, Zafira A, DAEWOO/CHEVROLET, FORD Sierra, Ka, Focus until 2007, Fusion, Mondeo until 1998, MAN Tga, L 2000, CHEVROLET

4800-7 A 161867

BMW 5-, 7- and X-series

4800-8 A 161874

BMW 1-series (E87), 3-series, Z3,

ROVER Range-Rover

4800-9 A 161881

## Adapter for Cooling System



### Optional extensions for assortments

- Threads exactly adapted to the opening of the expansion tank
- With coupling fitting for connection to the quick coupling of cooling pump 4800-1

Made in Germany

HAZET No.	FAN-No. 4000896+
-----------	------------------

### Options for assortments:

#### Adapters for Radiator RENAULT

4800-10 022250

SMART For Four, FORD, KIA and Japanese cars

4800-11 022267

AUDI A1 (since 2010), A2, A3, A4, A5 since 2007, A6, A8, TT, Q5, Q7, R8, VW-Passat B5, Eos, Bora, T5, LT, Golf 4, 5, 6, Vento since 1997, Jetta, SEAT Toledo since 1998, Leon, SKODA Octavia, Fabia since 1998, Roomster, Superb, PORSCHE Cayenne, Panamera

4800-12 A 161898

## Adapter for Cooling System

HAZET No.	FAN-No. 4000896+
-----------	------------------

VW-Sharan, FORD-Galaxy, SEAT Alhambra

4800-13 A 161904

MERCEDES-BENZ type 168, 169 (A-Class), 245 (B-Class), CDI, 220, 129

4800-14 079018

MERCEDES-BENZ type 202/203 (C-Class) 124/210/211(E-Class) and 129/220(S-Class), 164 (M-Class), 251 (R-Class)

4800-15 079025

MERCEDES-BENZ SLK, CLK, Sprinter since 1999 type 170, 208, 611, MINI since 2001

4800-16 098507

OPEL Vectra C, Astra H, Meriva, Signum, Corsa, Insignia

4800-17 109661

MERCEDES-BENZ Sprinter since 2006, Viano since 2003

4800-18 128815

VW Crafter

4800-19 128822

IVECO Euro-Star, Euro-Tech, Euro-Truck, MAN F90, F2000, MERCEDES-BENZ commercial vehicles Actros, Atego 1217 until 1999, Eco 8401, SK1728

4800-20 144242

MAZDA 3, VOLVO C30, S40 since 2004, V50,

FORD Focus since 2008, Fiesta since 2008,

C-Max, Galaxy since 2006, Kuga and S-Max

4800-21 A 162185

CITROËN C1, DAIHATSU Cuore L201, L501, Move L601, MAZDA 121, Demino, MITSUBISHI Grandis since 2004, L400, Pajero Pinin/Sport, Space-Gear, -Runner, -Wagon, PEUGEOT 107 since 2006, ROVER 620Si, 600, SUBARU B9 Tribeca, Justy, SUZUKI Alto, TOYOTA Aygo since 2006, Celica, Corolla, Rav 4, Starlet, Yaris

4800-22 144266

DAIHATSU Standard, HONDA Accord, Civic, Legend, HYUNDAI, ISUZU, KIA, MAZDA 323 until 1994, 626 until 2002, 6, MX5, Premacy since 2000, RX8, MITSUBISHI Carisma, Eclipse, Galant, Lancer, Outlander, Pajero, Sigma, Spacewagon D since 2003, NISSAN 350Z, Almera, Maxima, Micra until 2004, Navara, Patrol 2.8D, Primera P11+P12, Terrano since 1996, Terrano II, X-Trail, TOYOTA Avensis, Carina E, SUZUKI Baleno, Wagon-R, SUBARU Forester, Impreza, Legacy, Outback, OPEL Agila 1.0 and 1.2 and SMART Forfour

4800-23 144273

## Universal Adapter



Made in Germany

HAZET No.	FAN-No. 4000896+
-----------	------------------

- For radiator openings  $\varnothing$  20 – 41 mm
- With 3-stage rubber for rough and precise adjustment

4800-30 078202

- Especially for Japanese vehicles  $\varnothing$  18 – 24 mm
- With clamp fastening

4800-31 078196

### Engine Leakage Tester



- For the diagnosis of engine defects, e.g. on inlet and exhaust valves, pistons/piston rings and cylinder head/cylinder head gasket
- Easy application, immediate test result

Germany **Made in Germany**

HAZET No.	EAN-No. 4000896+
<b>Tester with 1 adapter M 14 x 1.25 and M 18 x 1.5</b> 4795-1	083770
<b>Adapter for motorcycles</b> thread M12 x 1.25 (external thread) 4795-11	083787
<b>Adapter for motorcycles and diesel engines</b> thread M10 x 1 (external thread) 4795-12	083794
<b>Adapter for diesel engines</b> thread M24 x 2 (external thread) 4795-13	083800
<b>Adapter for VW diesel engines</b> incl. 4795-11 pin Ø 7 mm 4795-14	083817
<b>Adapter for multi-valve engines</b> M14 x 1.25 Length: 165 mm 4795-15	104345

### Optical Tester

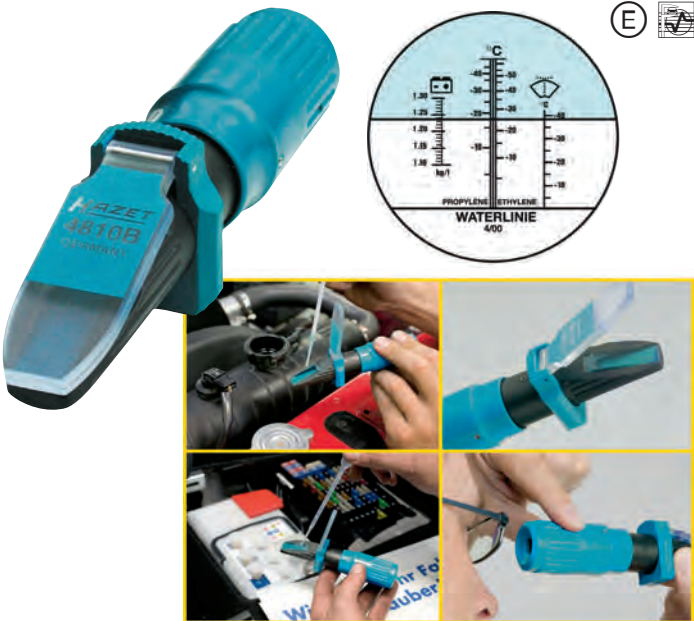

- For testing the **anti-freezing liquid concentration** in the cooling water ( $\pm 1^\circ \text{C}$ ) (also suitable for cooling fluid G 11 and G 12 **VOLKSWAGEN-AUDI, SEAT, SKODA**)
- For testing the **battery acid concentration**  $\pm 10 \text{ g/l}$  (state of battery charging)

Germany **Made in Germany**

HAZET No.	l mm	EAN-No. 4000896+
4810 B	162	083541

### Cylinder Head Leakage Tester



- For adapter for cooling system HAZET 4800
- For the detection of damage at the cylinder head
- For the safe detection of leakages between the combustion chamber and the cooling system on water-cooled combustion engines – **gas, diesel, petrol**
- Reaction fluid included

Germany **Made in Germany**

HAZET No.	EAN-No. 4000896+
<b>4800-41</b> Reaction fluid (250 ml)	058891
<b>4800-041</b>	108985

### Cylinder Head Tightness Tester



320 x 128 x 58mm

- For the detection of cylinder head gasket defects, leaks between the cooling system and the combustion chamber
- For water-cooled combustion engines (gas, diesel and gasoline)

Germany **Made in Germany**

HAZET No.	EAN-No. 4000896+
<b>3 pieces in sheet metal box</b> Contents: 4793-1 2 3	
<b>4793/3</b> Tester	076192
<b>4793-1</b> Reaction fluid (250 ml)	076185
<b>4793-2</b> Flushing fluid (250 ml)	076208
<b>4793-3</b>	076215





## Exhaust System / Lambda Probe

### Exhaust Equipment Tool



- Assembly hook for installing and removing rubber retainers of the exhaust equipment on e.g. **FORD** Fiesta, Orion, Escort, **BMW**, etc.
- Hook 40 mm, 9° offset
- With plastic T-handle
- Surface: chrome-plated

HAZET No.	l mm	EAN-No. 4000896+
4684-1	209	022199



- Assembly hook for installing and removing rubber retainers of the exhaust equipment on e.g. **VW**, **AUDI**, **MERCEDES-BENZ**, **OPEL**, Japanese cars, etc.
- Hook 17 mm, half-round, 20° offset
- With T-handle
- Surface: chrome-plated

HAZET No.	l mm	EAN-No. 4000896+
4684-2	209	022205

### Chain Pipe Cutter



- Chain pipe cutter for cutting exhaust pipes esp. suitable for pipes made of **V2A steel** up to a wall thickness of 2.5 mm and 80 mm Ø
- Extended cutting diameters by using extension chain HAZET 4682-01
- Low power required due to large T-screw that – fixed by **grip technique** – enables easy adjustment during cutting process
- Surface: nickel-plated

### Chain Pipe Cutter

HAZET No.	l mm	EAN-No. 4000896+
4682	255	022168
Repair Set (9 pieces) for cutting chain 4682-01		
4682-01/9	-	057214



Suitable up to a wall thickness of 6 mm and a Ø of 113 mm

- Chain pipe cutter for cutting pipes made of galvanized or stainless (V2A) steel, copper, PVC and aluminium up to a wall thickness of 6 mm
- 15 cutting wheels made of alloyed steel
- Pipe diameter of 21 up to 113 mm
- Easy adjustment due to large T-screw during cutting process
- Surface: nickel-plated

HAZET No.	l mm	EAN-No. 4000896+
4682-1	315	149384

Spare chain for 4682-1		
4682-03	-	149421

### Lambda Probe Socket



- For lambda probes on **NISSAN**, **FORD**, **VOLKSWAGEN**, **SEAT**, **SKODA** etc.
- Optimal fit to the 6-point profile of the lambda probe
- □ drive 12.5 = 1/2"
- Surface: chrome-plated
- **Made in Germany**

HAZET No.	d <sub>i</sub> mm	l mm	S mm	EAN-No. 4000896+
4680-1	30.4	92	22	165605



- For lambda probe on **MERCEDES-BENZ**
- □ drive 12.5 = 1/2"
- Surface: chrome-plated
- **Made in Germany**

HAZET No.	d <sub>i</sub> mm	l mm	S mm	EAN-No. 4000896+
4680-2	36	110	22	022090

### Lambda Probe Socket



Socket tip with esp. narrowed outside Ø

- For lambda probes on **VW** Golf 7 and **AUDI** A3 since 2013, 1.6 l and 2.0 l – 4 cyl. Common Rail, 4V, turbo charger
- □ drive 12.5 = 1/2"
- Surface: chrome-plated
- **Made in Germany**

HAZET No.	d <sub>i</sub> mm	l mm	S mm	EAN-No. 4000896+
4680-2 A	30	110	22	173761



- For lambda probes on **VW**, **AUDI**
- Outside hexagon 22 mm 22 mm
- □ drive 12.5 = 1/2"
- Surface: chrome-plated
- **Made in Germany**

HAZET No.	d <sub>i</sub> mm	l mm	S mm	EAN-No. 4000896+
4680-3	41	110	22	022106



- For installing and removing the lambda probe, e.g. on **FORD**, **BMW**, **OPEL**, **VW**, **AUDI**, **SEAT** and **SKODA**
- Double □ drive 12.5 = 1/2" or operation with hexagon drive s 30 mm
- Surface: phosphated
- **Made in Germany**

HAZET No.	S mm	EAN-No. 4000896+
4680-5	22	057870

# Specialty Tools for famous car manufacturers:

ALFA • AUDI • BMW • CHRYSLER • CITROËN • DAEWOO  
DAF • DAIHATSU • FIAT • FORD • HARLEY-DAVIDSON  
HONDA • HYUNDAI • ISUZU • IVECO • JAGUAR • KIA  
MAN • MAZDA • MERCEDES-BENZ • MITSUBISHI  
NISSAN • OPEL • PEUGEOT • PORSCHE • RENAULT  
ROVER • SAAB • SCANIA • SEAT • SKODA • SMART  
SUBARU • SUZUKI • TOYOTA • VOLVO • VW

Engine



## Specialty Tools for:

- ✓ Engine Timing / Engine Electricity
- ✓ Gearbox and Shafts
- ✓ Chassis and Brakes
- ✓ Body and Interior Equipment
- ✓ Fuel Supply
- ✓ Oil Service  
and many more ...







# Gearbox

Tools for the following fields of application:

- Gearbox
- Clutch
- Flywheel

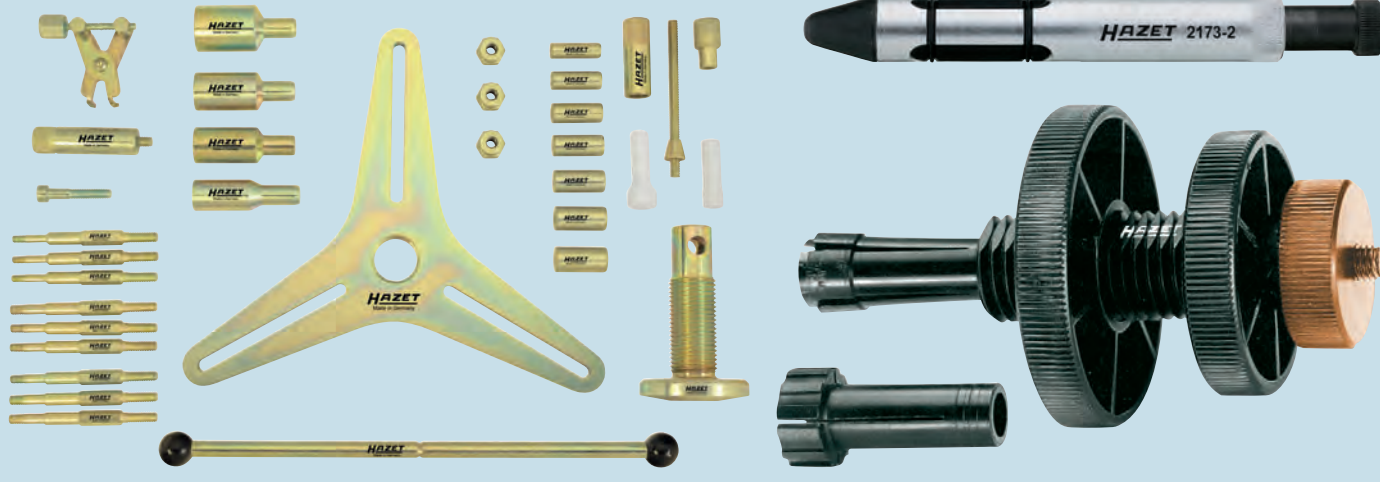

Gearbox

## Socket for the Reverse Gear Switch



- For the operation of switches, e.g. the reverse gear switch at the gear or the axles e.g. on **MERCEDES BENZ** commercial vehicles of the SK series, **Actros**, **MAN** commercial vehicles
- 27 mm **8-point special profile**
- Especially relieved
- □ drive 12.5 = 1/2"
- Surface: chrome-plated
- **Made in Germany**

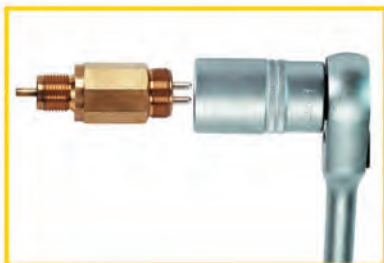

HAZET No.	l mm	EAN-No. 4000896+
2716-1	60	086405

## Clutch-Centering Mandrel



## Clutch-Centering Mandrel

- For fast and exact clutch plate centering on vehicles **with clutch guide bearing**
- For passenger cars and small commercial vehicles
- Infinitely variable
- Surface: chrome-plated

**Made in Germany**

HAZET No.	∅ mm	l mm	EAN-No. 4000896+
Clamping range 14.2–18.76 mm			
2173-1	15–19	160	013524
Clamping range 19.2–28.76 mm			
2173-2	20–26.6	175	013555

## Clutch-Centering Tool



- For the **correct centering and installation of the clutch plate to the pressure plate**
- Fast and easy installation
- No need to center the clutch plate by the needle bearing
- Also suitable for vehicles **without** clutch guide
- For passenger cars and small commercial vehicles
- With 2 collets:
  - size 1 = 15–21 mm ∅
  - size 2 = 21–28 mm ∅
- Plastic with metal clamping screw

HAZET No.	EAN-No. 4000896+
2174	013609

**SAC Clutch Alignment Tool Set (3-hole division), 34 pieces**

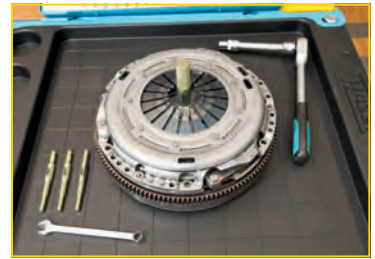

**For the professional installation and removal of self-adjusting clutches e.g. on VW, AUDI, BMW, FORD, MERCEDES-BENZ, OPEL, RENAULT, VOLVO**

- High-precision, accurately fitting components manufactured according to the newest CNC production techniques guarantee optimal working
- Suitable for SAC (self-adjusting) clutches with 3 hole division
- With centring option of the clutch
- Operation of the adjusting ring possible
- Prevents distortion of the adjusting ring in the clutch pressure plate
- Optimal usage for a damage-free working on the SAC clutch
- Avoids malfunctions such as bad separating, slipping or judder
- Easy change from 3-hole to 4-hole pressure plate
- High-quality surface prevents damage of tools
- Components and Spare Parts available
- Sturdy case for storage of tools

- Oil-resistant foam insert
- Foam insert with option for storage of the Expansion Set 2174-2/5 (4-hole division)
- Includes detailed operating instructions

34 pieces

**Made in Germany**

Contents:  
2174-08 012 014 015 016 017 018 019  
2174-6 7 8 9 10 11 13 15 (3x)  
2174-15x23 15x26,5 15 x 28 15 x 34  
2174-16 17 18 19  
2174-171 172

<b>HAZET</b> No.	EAN-No. 4000896+
2174-1/34	174591

**Expansion Set SAC Clutch Alignment Tool (4-hole division), 5 pieces**



**For SAC Clutch Alignment Tool Set 2174-1/34**

- 4-hole pressure plate necessary for e.g. **MERCEDES BENZ**, type 169 since 2004 (A-Class) **OPEL** Insignia
- High-precision, accurately fitting components manufactured according to the newest CNC production techniques guarantee optimal working
- High-quality surface prevents damage of tools
- Easy storage in tool set case 2174-1/34

5 pieces

**Made in Germany**

Contents:  
2174-6 7 8 14 15

<b>HAZET</b> No.	EAN-No. 4000896+
2174-2/5	174607





# Oil Service

- ✓ Oil Service Wrench
- ✓ Universal Strap Wrench
- ✓ Oil Filter Chain Wrenches
- ✓ Oil Filter Claw Wrench

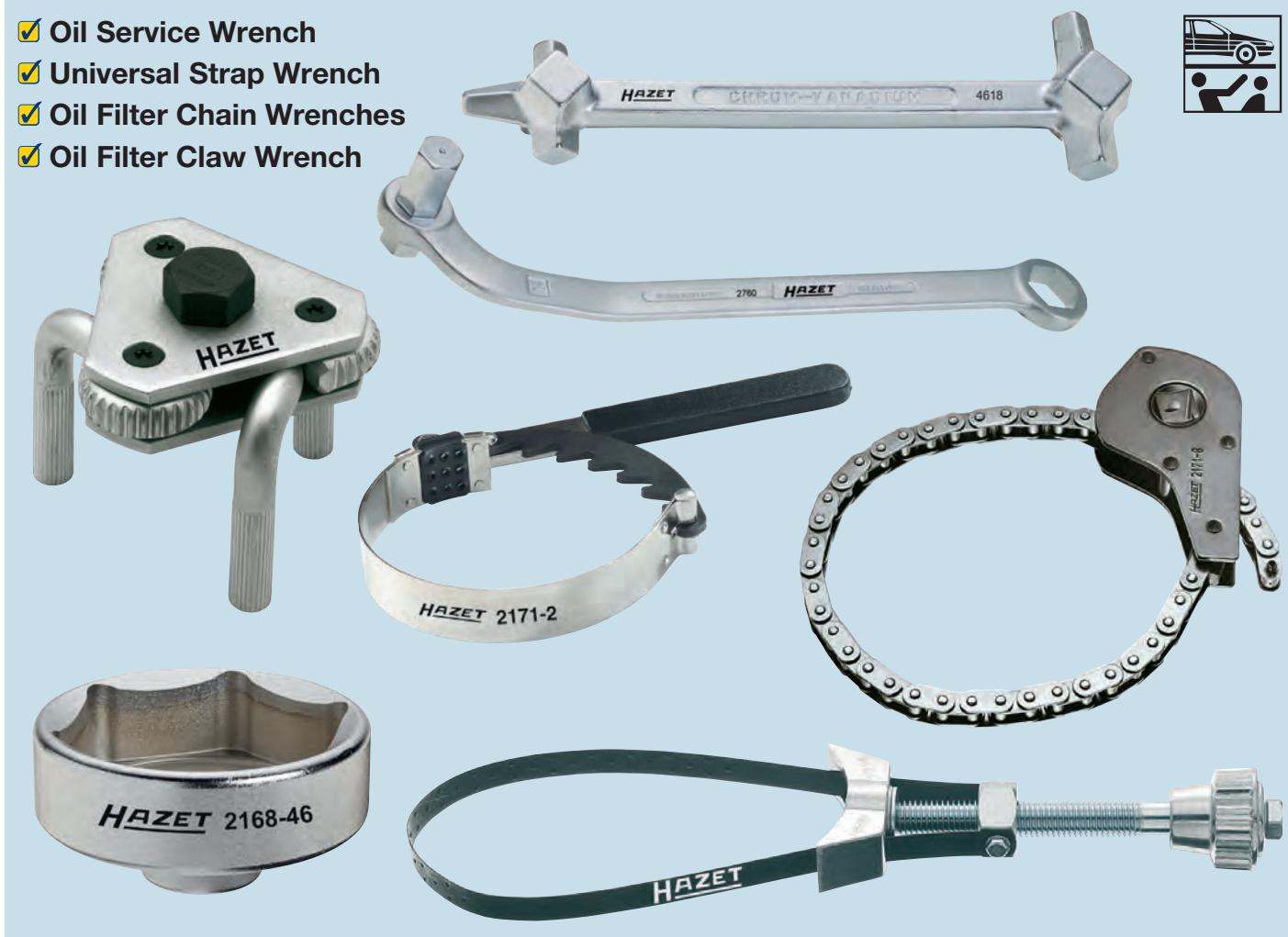

## Overview Oil Filter Wrenches

HAZET No.	Execution Points / Grooves	Oil Filter $\varnothing$ mm	Oil Filter Wrench $\varnothing$ mm	Insert Depth Wrench mm	Total Height mm	Drive $\varnothing$ mm	□
2168	–	54	58.5	9	25	22	12.9 1/2
2168-6	6-Point	109.5	117.5	65	77	–	10 3/8
2168-46	6-Point	46	59	15	29.5	–	10 3/8
2169	14-Point	74.4	82	30	52	27	10 3/8
2169-1	15-Point	92	102	19	48	27	12.9 1/2
2169-5	18-Point	135	148	41	57	24	12.9 1/2
2169-6	16-Point	86.7	97	44.5	55.5	24	12.9 1/2
2169-7	14-Point	64	76	23	43	24	12.9 1/2
2169-8	15-Point	74	84	24	42	24	12.9 1/2
2169-10	14-Point	74	82	20	42	27	10 3/8
2169-11	14-Point	84	97	30.5	48.5	24	12.9 1/2
2169-32	6-Point	32	43	18	30	–	10 3/8
2169-36	6-Point	36	49.5	15.2	29.5	–	10 3/8
2169-66	6 Grooves	66	76	23.5	43.5	24	12.9 1/2
2169-76	6 Grooves	76	85	21	42	24	12.9 1/2
2169-76 K	6 Grooves	76	85	14.5	34	24	12.9 1/2
2169-86	9 Grooves	86	97	24.5	44	24	12.9 1/2

### Oil Filter Wrench

12.5 1/2



- For the operation of **oil and fuel filters**
  - For **MANN oil and fuel filters**: W 920, W 920/7, W 930, W 930/9, W 940, W 940/15, W 940/20, W 940/25, W 950, W 950/1, W 950/5, W 962/2, W 962/7, W 962/14, W 1130/1, WK 940/4, WK 950/4, WK 962/5, WP 931 and WP 962/3, as well as **KNECHT and MAHLE oil filters**: OC 51, OC 83 and OC 214
  - drive 12.5 = 1/2" or outside hexagon 22 mm
  - Forged design
  - Surface: chrome-plated
- Made in Germany**

HAZET No.	mm	mm	EAN-No. 4000896+
2168	22	59	013333

### Fuel Filter Wrench

10 3/8



- For the damage-free operation of the filter housing cap when changing the fuel filter**
- Drive 10 mm = 3/8" – Ø 109 mm with 6 grooves
  - Application e.g. on **FIAT / ALFA / LANCIA** with 1.3 l – 1.9 l – 2.4 l diesel engines as well as **OPEL** Vectra C / Signum 1.9 l diesel, Astra H 1.3 l and 1.9 l diesel, Corsa C / Combo / Meriva 1.3 l diesel engines
- Notice:** The torque value for the housing cap recommended by the car manufacturers may be reached when using e.g. the HAZET Torque Wrench 6110-1 CT
- Made in Germany**

HAZET No.	mm	EAN-No. 4000896+
2168-6	117.5	149070

### Ad-Blue® Filter Wrench

10 3/8



- For the operation of the filter housing cap when replacing the AdBlue® filter (urea solution filter) on MERCEDES-BENZ-commercial vehicles with BlueTec® engines e.g. Actros, Atego, Axor, Econic**
- The torque value recommended by the vehicle manufacturer (please consider manufacturers' instructions) is reached e.g. with the torque wrench HAZET 6110-1 CT
  - drive 10 = 3/8"
  - Ø 46 mm
- Made in Germany**

HAZET No.	mm	EAN-No. 4000896+
2168-46	59	156252

### Oil Filter Wrench

10 3/8



- For the operation of **oil filters and oil filter housing caps** 14-point s 74.4 mm
  - drive 10 = 3/8" or outside hexagon 27 mm
- Made in Germany**

HAZET No.	mm	mm	EAN-No. 4000896+
2169	27	82	013340

- For **MANN, KNECHT and OPEL** Longlife filters e.g. for **MERCEDES-BENZ** passenger cars with 2.2 l CDI-engine, M 102, M 103, M 104, M 110, M 111, M 119, M 120, M 613, Sprinter 2.2 l Turbo since 2006, **AUDI** A4 2.0 since 2002, A4 4-cyl. petrol engines since 12/2007, **BMW, BMW-motorcycles**, K-models = K 75-1100 LT, new series F and K **VW-Passat** 1.9 TDI pump-nozzle injection, Golf Plus 2.0 since 2005, Golf 6 1.6 l and 1.2/1.4/1.8/2.0 TSI, Polo 5 1.2l – 1.4l TSI, Tiguan since 2007 1.4l TSI (110kW) 2.0l TSI as well as **FORD, OPEL, PORSCHE, PEUGEOT, CITROËN, RENAULT, NISSAN, TOYOTA, MAZDA** etc.
- | 2169   | 27 | 82 | 013340 |
|--|----|----|--------|
| • For the operation of the <b>oil filter housing cap</b> when changing the oil filter element on <b>MAZDA</b> 3 with 2.0 l engine and 6 with 1.8–2.0–2.3 l engines |    |    |        |
| • Flat style: <b>continuous 14-point profile up to the edge</b>  |    |    |        |
| 2169-10  | 27 | 82 | 108831 |

### Oil Filter Wrench

12.5 1/2



- For the operation of **oil filters (KNECHT- and MAHLE filters)** 15-point s 92 mm e.g. **VW, AUDI** Passat 1.9 TDi until 11/00, 2.8 l until 04/1999, **CHRYSLER** 300 M, **PORSCHE, OPEL, RENAULT, FORD** Focus 1.8 Di since 08/1999, 1.8 TDi since 10/98, **Maverick** 2.7 TD until 1996, **Mondeo** 2.5 l until 2000, **MITSUBISHI, NISSAN, ALFA-ROMEO, HONDA, VOLVO** etc. **MAN** (Nzf) F 2000
  - drive 12.5 = 1/2" or outside hexagon 27 mm
- Made in Germany**

HAZET No.	mm	mm	EAN-No. 4000896+
2169-1	27	102	013357



- For the operation of oil filters and plastic oil filter housings**
- drive 12.5 = 1/2" or outside hexagon 24 mm
- Made in Germany**

HAZET No.	mm	mm	EAN-No. 4000896+
2169-5	24	148	100330

- For the operation of plastic oil filter housings**
- **18-point s 135 mm** on **MAN** commercial vehicles of the series F 2000 and TGA
- | 2169-5  | 24 | 148 | 100330 |
|---|----|-----|--------|
| • For the operation of plastic oil filter housings  |    |     |        |
| • <b>16-point s 86 mm</b> , e.g. on <b>BMW</b> 316i Limousine Touring, 316ti Compact, 318Ci Cabrio, Coupé, 318i Limousine Touring, Compact since 2001, 1 Series (E87): 116i, 118i, 120i, 130i |    |     |        |
| <b>VOLVO</b> V40, V70, S40, S60, S70, S80   |    |     |        |
| 2169-6  | 24 | 97  | 100293 |

- For the operation of **oil filters** 14-point s 64 mm on **TOYOTA** Yaris, Corolla, MR2 until 1999, Starlet, Celica, Avensis, **NISSAN** Micra, Almera, **MAZDA** 323, 626, MX-5, Xedo, **SMART** ForFour (type 454) engine 134, 135, **SMART** Fortwo (Typ 451) engine 132
- Also suitable for **YAMAHA** Super Ténéré XT1200 z, YZF-R1 since 2007, YZF-R6 since 2006, FZ1-S since 2006, FZ1-N since 2006, FZ6-S since 2007, FZ6-N since 2007
- | 2169-7   | 24 | 77 | 100224 |
|--|----|----|--------|
| • For the operation of <b>MANN oil filters</b> 15-point s 74 mm on <b>OPEL</b> (oil filters with T-No. 650 401), Kadett E, Corsa A, B, C, Omega A, B, Astra F, G, Vectra A, B, Calibra, Frontera, <b>SAAB</b> 900 2.5 l, 9000 3.0 l, LADA Shiguli 2110 2.0 l |    |    |        |
| 2169-8   | 24 | 84 | 100316 |

- For the operation of **oil filters** 14-point s 84 mm
  - For the operation of plastic oil filter housings, e.g. on – **MERCEDES-BENZ** diesel engines 3.0 V6, engine 642, from C-Class on
- | 2169-11   | 24 | 97 | 118847 |
|---|----|----|--------|
| • For the operation of plastic oil filter housings, e.g. on – <b>MERCEDES-BENZ</b> diesel engines 3.0 V6, engine 642, from C-Class on |    |    |        |
| 2169-11   | 24 | 97 | 118847 |





## Specialty Tools – Oil Service

### Oil Filter Wrench

12.5 1/2



- For installing and removing **oil filters and oil filter housing caps** when changing the filter element
- drive 10 = 3/8"
- Forged design
- Surface: chrome-plated
- **Made in Germany**



HAZET No.	mm	mm	EAN-No. 4000896+
-----------	----	----	------------------

- **6-point s 32 mm**  
**OPEL** Astra, Corsa, 1.9 I CDTi  
**VW** Passat, Golf 6 with 1.6 and 2.0 CR-TDI, Polo 5 1.2I-1.4I TDI, Polo 1.2 I petrol engines since 2005, Transporter T5 1.9 I diesel since 2004, Touran TDi, Tiguan since 2007 1.4I (90/118kW) 2.0I diesel engines, **AUDI** A6 3.2 I TSI, V6 since 2004, A4 diesel since 12/2007  
**BMW** 530d M57 since 2008  
 For urea solution filter Ad-Blue® **MAN** e.g. TGX

2169-32	32	43	082346
---------	----	----	--------

- **6-point s 36 mm**  
 e.g. for **MERCEDES-BENZ** engine 116 MB, 100 D Transporter, Actros MP 1, MP 2, **BMW** M 52-6 cyl.: 3 Series since 9/1995, 5 Series since 11/95, M 60-8 cyl.: 5, 7 and 8 Series, M 73-12 cyl.: 7 Series, 8 Series, 1 Series (E87): 118d, 120d, **OPEL** Vectra B DI 16 V, Insignia, **VW** Lupo 1.2 TDI, model year 1999, Polo 5 1.2I, Golf 6 1.4I SRE/TSI, Touareg TDi, T5 2.5 D, **AUDI** 6 cyl. petrol engines since 12/2007  
 For **MAN** fuel filter e.g. TGA

2169-36	36	50	086566
---------	----	----	--------

12.5 1/2



- For the operation of **Purflux oil filters**
- 12.5 = 1/2" or outside hexagon s 24 mm
- **Made in Germany**

HAZET No.	mm	mm	EAN-No. 4000896+
-----------	----	----	------------------

- **s 66 mm groove profile (6 grooves)**
- **RENAULT** Clio, Twingo (also operation of the oil filter housing cap), Kangoo, **FIAT** Punto, Stilo, Brava, Bravo with 1.2 I, **LANCIA** Y 1.2 I, **MAZDA** 323, 626, MX 3, Xedos, **MITSUBISHI** Colt, Carisma, Space Star, **NISSAN** Micra, Primera, Serena, **TOYOTA** Yaris, Starlet, MR 2, Corolla, Carina, Avensis

2169-66	24	76	100217
---------	----	----	--------

- **s 76 mm groove profile (6 grooves)**
- For e.g. **AUDI** A3, A4, A6, **CITROËN** C5, Xantia, **FIAT** Brava, Bravo, Punto, Tipo, **FORD**-Fiesta, Escort, **MERCEDES-BENZ** passenger cars and Sprinter, **PEUGEOT** 106, 206, 306, 406, **RENAULT** Clio, Kangoo, Mégane, Laguna, Rapid, **HONDA** Accord, Civic, Prelude, CRX, **OPEL** Astra G/F, Corsa A/B, Calibra, Zafira, Frontera, **SUZUKI** Grand Vitara 1.9D model year 2009  
**VW** Golf 3 + 4, Polo, Passat, Sharan, **SEAT** Alhambra, Toledo, León, Córdoba, **SKODA** Octavia for **fuel filters**  
 e.g. for **RENAULT** Espace, Laguna, R19, **VOLVO** S 40 and V 40 until 1999

2169-76	24	85	100309
---------	----	----	--------

### Oil Filter Wrench

12.5 1/2

HAZET No.	mm	mm	EAN-No. 4000896+
-----------	----	----	------------------

#### Especially for BMW motorcycles

- **s 76 mm groove profile (6 grooves), reduced height**
- For new **BMW** motorcycles, R1200 GS, R1200 R, R1200 RT

2169-76 K	24	85	158188
-----------	----	----	--------

- **s 86 mm groove profile (9 grooves)**
- For e.g. **ALFA** 145, 146, 156 1.9 JTD, 156 2.4 JTD, **VW** Golf 3, Sharan, Vento, Passat until 1996 with TDi engine, Lupo, Polo 1.7 SDi, **AUDI** A4, A6 until 1996 with TDi engine 85 KW/115 PS, **FIAT** Bravo and Brava 1.9 JTD, **RENAULT** Clio, R 19 with 1.4–1.7 and 1.8 I, Mégane 1.4 and 2.0 I, Rapid with 1.9 D, Laguna, Safrane and Espace III with 2.1 D, **SEAT** Alhambra 1.9 TDI, Arosa 1.7 SDi, **SUZUKI** Grand Vitara 1.9 DDIS  
 for **fuel filters**  
 e.g. **MERCEDES-BENZ** Vito, Sprinter, A-Class (type 168), C-Class (type 202), E-Class (type 210)

2169-86	24	97	100323
---------	----	----	--------

### Oil Filter Wrench Set



#### For the operation of oil filters and oil filter housings made of plastic

- Fast application, safe, appropriate and clean working
- The torque value recommended by the vehicle manufacturer can be safely achieved, e.g. with the Torque Wrenches HAZET 6110-1 CT (10 = 3/8") and HAZET 6121-1 CT (12.5 = 1/2")
- **Caution:** Follow vehicle manufacturer's specifications concerning torque values

#### Contents

- 2169 36
- Alternative drive: outside hexagon s 27 mm
- Outside Ø 82 mm

- For the operation of **oil filters and oil filter housing caps 14-point s 74.4 mm**
- For **MANN-** and **KNECHT** filters, **OPEL** longlife filters
- On e.g. **MERCEDES-BENZ** passenger cars M 102, M 103, M 104, M 110, M 111, M 119, M 120, M 613, Sprinter 2.2 I Turbo since 2006, **AUDI** A4 2.0 since 2002, A4 4-cyl. petrol engines since 12/2007, **BMW**, **BMW** motorcycles, K-models = K 75-1100 LT, **VW**-Passat 1.9 TDI pump-nozzle injection, Golf Plus 2.0 since 2005, as well as on **FORD**, **OPEL**, **PORSCHE**, **PEUGEOT**, **CITROËN**, **RENAULT**, **NISSAN**, **TOYOTA**, **MAZDA** etc.

#### 2169-36 36

- For installing and removing **oil filters and oil filter housing caps** when changing the filter element **6-point s 36 mm**
- On e.g. **MERCEDES-BENZ** engine 116 MB, 100 D Transporter, Actros MP 1, MP 2, **BMW** M 52-6 cyl.: 3 Series since 09/1995, 5 Series since 11/1995, M 60-8 cyl.: 5 Series, 7 Series, 8 Series, M 73-12 cyl.: 7 Series, 8 Series, 1 Series (E87): 118d, 120d, **OPEL** Vectra B DI 16 V, **VW** Lupo 1.2 TDI, model year 1999, **VW** Touareg TDi, **VW** T5 2.5 D, **AUDI** 6-cyl. petrol engine since 12/2007
- For **fuel filters** **MAN** e.g. TGA

### Oil Filter Wrench Set

2169-6 1/2

- Alternative drive: outside hexagon s 27 mm
- Outside Ø 97 mm
- For the operation of **plastic oil filter housing caps 16-point s 86 mm**
- On e.g. **BMW** 316i Limousine Touring, 316ti Compact, 318Ci Cabrio, Coupé, 318i Limousine Touring, Compact since 2001, 1 Series (E87): 116i, 118i, 120i, 130i, **BMW** N42 engine  
**VOLVO** V40, V70, S40, S60, S70, S80

#### 2169-76 1/2

- Alternative drive: outside hexagon s 24 mm
- Outside Ø 85 mm
- For the operation of **Purflux oil filters s 76 mm groove profile (6 grooves)**
- On e.g. **AUDI** A3, A4, A6, **CITROËN** C5, Xantia, **FIAT** Brava, Bravo, Punto, Tipo, **FORD**-Fiesta, Escort, **MERCEDES-BENZ** passenger cars and Sprinter, **PEUGEOT** 106, 206, 306, 406, **RENAULT** Clio, Kangoo, Mégane, Laguna, Rapid, **HONDA** Accord, Civic, Prelude, CRX, **OPEL** Astra G/F, Corsa A/B, Calibra, Zafira, Frontera, **VW** Golf 3 + 4, Polo, Passat, Sharan, **SEAT** Alhambra, Toledo, León, Córdoba, **SKODA** Octavia
- For **fuel filters** e.g. on **RENAULT** Espace, Laguna, R19, **VOLVO** S 40 and V 40 until 1999

#### 2169-1 1/2

- Alternative drive: outside hexagon s 27 mm
- Outside Ø 102 mm
- For the operation of **oil filters, 15-point s 92 mm**
- For **KNECHT-** and **MAHLE** filters
- On e.g. **VW**, **AUDI** Passat 1.9 TDI until 11/00, 2.8 I until 04/1999, **CHRYSLER** 300 M, **PORSCHE**, **OPEL**, **RENAULT**, **FORD** Focus 1.8 Di since 08/1999, 1.8 TDi since 10/1998, **Maverick** 2.7 TD until 1996, **Mondeo** 2.5 I until 2000, **MITSUBISHI**, **NISSAN**, **ALFA-ROMEO**, **HONDA**, **VOLVO** etc. **MAN** (commercial vehicles) F 2000

#### 2169-86 1/2

- Alternative drive: outside hexagon s 24 mm
- Outside Ø 97 mm
- For the operation of **Purflux oil filters 86 mm groove profile (9 grooves)**
- On e.g. **ALFA** 145, 146, 156 1.9 JTD, 156 2.4 JTD, **VW** Golf 3, Sharan, Vento, Passat until 1996 with TDi engines, Lupo, Polo 1.7 SDi, **AUDI** A4, A6 until 1996 with TDi engines 85 KW/115 PS, **FIAT** Bravo and Brava 1.9 JTD, **RENAULT** Clio, R 19 with 1.4–1.7 and 1.8 I, Mégane 1.4 and 2.0 I, Rapid with 1.9 D, Laguna, Safrane and Espace III with 2.1 D, **SEAT** Alhambra, 1.9 TDI, Arosa 1.7 SDi, **SUZUKI** Grand Vitara 1.9 DDIS
- For **fuel filters** e.g. on **MERCEDES-BENZ** Vito, Sprinter, A-Class (type 168), C-Class (type 202), E-Class (type 210)

#### **Made in Germany**

HAZET No.	mm	mm	EAN-No. 4000896+
2169	24	76	100217
2169-1	24	85	100309
2169-36	24	97	100323
2169-6	24	102	100324
2169-76	24	85	100309
2169-86	24	97	100323
2169/6	24	76	120628

### Universal Strap Wrench



- Especially for oil filter, generator and other round screwed connections
- Cotton textile tape, rubber coated
- Non-skidding
- Surface: chrome-plated
- **Made in Germany**

HAZET No.	mm	EAN-No. 4000896+
2170	160	013371

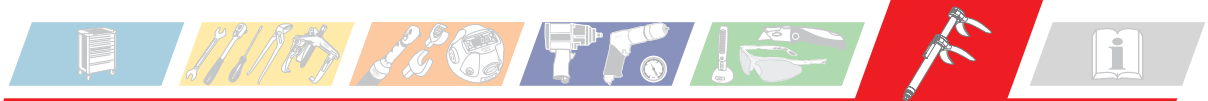

Oil Service

**Oil Filter Wrench**



- For the operation of oil filters, e.g. as assembly tool for oil and fuel filters on commercial vehicles **MAN**
- Adjustable steel strip

**Made in Germany**

HAZET No.	∅ mm	EAN-No. 4000896+
□ drive 12.5 = 1/2"		
2171-1	80–110	013418
With lever		
2171-2	75–110	013432



- For removing oil filters even in areas with restricted access
- Adjustable by turning knob or 6-point 13 mm 13 mm
- Replaceable steel strip (12 x 1 mm)

HAZET No.	∅ mm	EAN-No. 4000896+
2171-5	65–105	013449
2171-6	105–145	013456

**Oil Filter Chain Wrench**



- For removing oil filters and for the operation of the granulates cartridge on commercial vehicles with compressed air dryers
- Even in areas with restricted access
- With chain
- □ drive 12.5 = 1/2"

**Made in Germany**

HAZET No.	∅ mm	EAN-No. 4000896+
2171-8	50–150	013463

**Oil Filter Wrench**



**Oil Filter Wrench**

- For oil filters in areas with restricted access
- Left-hand and right-hand operation
- Universal application
- □ drive 10 = 3/8" or ● 19 mm
- Forged design
- Surface: galvanized

**Made in Germany**

HAZET No.	∅ mm	EAN-No. 4000896+
2172	65–115	013470

**Ball-Head Screwdriver Socket**



- For the oil pan of 5 cyl. diesel engines on Transporter T4, **AUDI** TT since 1999
- □ drive 10 = 3/8"
- For inside hexagon screws

**Made in Germany**

HAZET No.	l <sub>1</sub> mm	l <sub>2</sub> mm	S mm	EAN-No. 4000896+
2527-5	200	227	5	016303

**Oil Pan Socket**



- For the oil pan
- □ drive 10 = 3/8"
- With ball joint and T-handle
- Surface: chrome-plated

**Made in Germany**

HAZET No.	l mm	S mm	EAN-No. 4000896+
2528-10	250	10	016327

**Oil Service Socket**



- For screws with internal serration (**XZN**) with hole for guiding pin
- For the oil drain plug at the gearbox **AUDI** A2, A3, A4, A6, TT **VW** Passat B5, Golf 4, LT, T4, T5 **SKODA** Fabia, Octavia, Superb **PORSCHE** Boxster with shift gear **FORD** Galaxy 1.9 TDi with 6-speed gear box
- □ drive 12.5 = 1/2"
- Surface: chrome-plated

**Made in Germany**

HAZET No.	l mm	M	EAN-No. 4000896+
2567-16	60	16	016419

**Oil Service Wrench**



- For oil filler screw on M 8 gearbox
- Surface: chrome-plated

**Made in Germany**

HAZET No.	l mm	S mm	EAN-No. 4000896+
Types 100, 110, 115, 116, 117, 615, 616, 617			
2760	237	14 x 17	017638
Types 102, 103, 104, 110, 115, 116, 117, 119, 120, 123			
2760-2	287	13 x 14	017652



- For the oil filler and oil drain plug gearbox, differential, oil pan on various French passenger cars
- 8 and 10 mm outside square
- Surface: chrome-plated

**Made in Germany**

HAZET No.	l mm	S mm	EAN-No. 4000896+
3703	233	8 x 10	018932

**Oil Service Screwdriver Socket**



- For the oil filler and oil drain plug gearbox, differential, oil pan
- □ drive 12.5 = 1/2"
- Surface: chrome-plated

**Made in Germany**

HAZET No.	l mm	S mm	EAN-No. 4000896+
• 8 mm outside square			
• For <b>PEUGEOT</b> , <b>VOLVO</b> 264, <b>RENAULT</b> since 1983, <b>NISSAN</b> Micra 1.5 D since 1998			
3702	36	8	018918
• 10 mm outside square			
• For <b>FORD</b> Sierra, Granada diesel, <b>VOLVO</b> V6, <b>PEUGEOT</b> 106, 205, 305, 306, 309, differential <b>MAZDA</b> with rear drive			
3702-1	36	10	018925

**Oil Service Wrench**



- For the oil filler and oil drain plug on gearbox, differential, oil pan e.g. on **FORD**
- With different squares 8.7 9.5 10.5 11.5 13 6.8 15.2 16.5 19.7
- Surface: chrome-plated

**Made in Germany**

HAZET No.	l mm	EAN-No. 4000896+
4618	218	021994





# Brakes

- ✓ Brake Bleeding Set
- ✓ Brake Adjusting Lever
- ✓ Brake Fluid Tester
- ✓ Brake Piston Readjusting Set
- ✓ Tube Flaring Tools
- ✓ Files
- ✓ Tools for Hand Brakes and many more ...



## Brake Pressure Regulator and Wheel Bearing Socket



125° 1/2"

- 6-Point Socket
- For adjusting of torsion bars
  - installation of brake pressure regulators
  - removing of wheel bearings on VW transporter T4
- □ drive 12.5 = 1/2"
- Surface: matt chrome-plated

Made in Germany

HAZET No.	l mm	S mm	EAN-No. 4000896+
2583	140	27	017034

## Brake Calliper Screwdriver Socket



10° 3/8"



## Brake Calliper Screwdriver Socket



- For the operation of the brake calliper screws at the rear axle  $\leq 8$  mm on:
  - AUDI TT since 2007, A4 since 2001, A6 since 2005, A8 since 2003
- For controlled screw tightening use a torque wrench with 10 mm = 3/8" drive, e.g. HAZET 6110-1 CT
- With fix blade (size 8 mm) for inside hexagon screws

Made in Germany

HAZET No.	d mm	l1 mm	l2 mm	S mm	EAN-No. 4000896+
2584-8	19	7	24	8	149438



10° 3/8"



- For the operation of the guide bolts  $\leq 7$  mm at the rear brake callipers on MERCEDES-BENZ type 204 (C-Class)
- For controlled screw tightening use a torque wrench with 10 mm = 3/8" drive, e.g. HAZET 6110-1 CT
- With fix blade (size 7 mm) for inside hexagon screws

## Brake Calliper Screwdriver Socket



Made in Germany

HAZET No.	d mm	l1 mm	l2 mm	S mm	EAN-No. 4000896+
2784-1	19	7	24	7	148530



For the operation of the brake calliper screws (Knorr-Bremse) on MERCEDES-BENZ commercial vehicles e.g. Actros

- Enables controlled screwing with the torque value required by the manufacturer (Follow manufacturer's instructions) e.g. with torque wrench HAZET 6144-1CT
- Drive allows transmission of high separation forces
- □ drive 20 = 3/4"
- O 14 mm

Made in Germany

HAZET No.	l1 mm	l2 mm	S mm	EAN-No. 4000896+
2784-14	60	110	14	155583

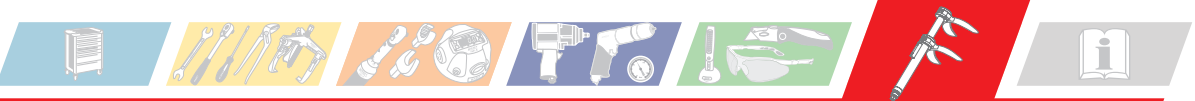

### Brake Calliper Screwdriver Socket



- For inside hexagon screws on rear brake callipers on **BMW** 3, 5 and 8 Series as well as on **OPEL**
- □ drive 10 = 3/8"
- **Made in Germany**

HAZET No.	l mm	S mm	EAN-No. 4000896+
2901 G-7	48.5	7	051816

### Brake Calliper TORX® Socket



For the operation of the brake calliper screw on **MAN** commercial vehicles

- Operation e.g. with HAZET Box-End Insert Tool 6630 d-22 with Tool Holder 6397 (screw loosening) or Torque Wrench 6293-1 CT or 6295-1 CT (screw tightening)
- **Made in Germany**

HAZET No.	l mm	EAN-No. 4000896+
• For e.g. <b>MAN</b> TGM and TGL		
2871-E 18	39.5	176175
• For e.g. <b>MAN</b> -TGM, TGA – outside TORX® E 20		
2871-E 20	39.5	148790
• For e.g. <b>MAN</b> -TGA, TGS, TGX – outside TORX® E 24		
2871-E 24	39.5	148783

### Brake Bleeding Wrench Set



- 5 pieces, 7 – 11 mm
- **Made in Germany**

Contents:  
4968-7 8 9 10 11

HAZET No.	EAN-No. 4000896+
4968/5	086535

### Application Chart for Brake Bleeding Wrenches No. 4968

Car Model	S mm				
BMW	7				
CITROEN		8	9		
DAIHATSU		8			
FIAT	7	8			
FORD	7	8	9	10	11
HONDA		8		10	
MAZDA		8			
MERCEDES-BENZ			9		11
MITSUBISHI				10	11
NISSAN				1010	11
OPEL			9		
PEUGEOT	7	8	9	10	11
RENAULT	7	8	9		11
SEAT	7	8			
SUZUKI				10	
TOYOTA		8		10	
VOLVO		8		10	11
VW-AUDI	7				11

### Brake Bleeding Wrench



- For brake bleeding without dismounting the wheels, replacement of wheel brake cylinder, master brake cylinder and tube connections
- Bent and offset
- Equal hexagon size on both sides
- Surface: chrome-plated
- **Made in Germany**

HAZET No.	l mm	S mm	EAN-No. 4000896+
4968- 7	190	7	085705
4968- 8	208	8	085699
4968- 9	208	9	085682
4968-10	236	10	085712
4968-11	236	11	085729

### Special Tool for Brakes



### Special Tool for Brakes

- For installing and removing spring plates and the holding device of brake linings on drum brakes, e.g. on **VW**, **SEAT**, **SKODA**, **OPEL** and **RENAULT** with rear drum brakes
- Push- and turn-part with carbide coating layer in front working area
- Plastic handle
- Surface: chrome-plated
- **Made in Germany**

HAZET No.	l mm	EAN-No. 4000896+
4963-1	237	050383

### Assembly Tool



- For installing and removing the **draw spring of hand brake shoes**, e.g. on **MERCEDES-BENZ** passenger cars as well as on **VW** Crafter since 2006 and LT since 1997
- Hook with T-Handle
- Surface: chrome-plated

HAZET No.	l mm	EAN-No. 4000896+
4964-1	162	055708

### Cartridge Wrench



For loosening the granulates cartridge on commercial vehicles with compressed air dryer e.g. on **MERCEDES-BENZ** and **MAN**

- Design "Made by HAZET"
- Negative position of arms
- Forged design
- MAN-No. 8099606-0307
- □ drive 12.5 = 1/2"
- Surface: burnished
- **Made in Germany**

HAZET No.	∅ mm	EAN-No. 4000896+
2195	90-140	014101





## Specialty Tools – Brakes

### Tube Flaring Tool Set

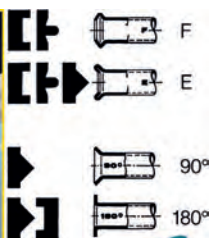

290 x 173 x 50 mm

- For metal tubes and pipes with a wall thickness of 0.7 und 1.0 mm pipe- $\varnothing$  4.75– 10 mm
  - For open (F) or double (E) flares according to DIN 74234, for normal 90°- and 180° flares
  - For flares on rolled and drawn pipes
  - With replaceable hinged gripping jaws
- Note: For plastic coated brake lines use HAZET 2193/4K!**

- Special cast steel
- **Set of 12 pieces**
- In sheet metal box
- Surface: lacquered

Contents:

- 1 Tube Cutter 2181-1
- 1 Tube Flaring Unit 2191
- 1 Gripping Jaw 2191-1
- 1 Tube Deburring Tool 2191-2
- 1 Base Block 2191-3
- 6 Thrust Blocks 2191-4 to 2191-10
- 1 90°- Thrust Block 2191-90

**Made in Germany**

Contents:

- 2181-1 2191
- 2191-1 2 3 4 5
- 6 8 9 10 90

HAZET No.	EAN-No. 4000896+
2191/12 K	013890

### Basic appliance



- For tubes with a wall thickness of 0.7 and 1.0 mm
- Made in Germany**

HAZET No.	EAN-No. 4000896+
2191	013784

### Gripping Jaw



- For "E" and "F" flares 4.75 up to 10 mm

**Made in Germany**

HAZET No.	mm	EAN-No. 4000896+
2191-1	4.75–5–6–8–9–10 mm	013791

### Tube Deburring Tool



- For tube deburring
- For tubes with outside  $\varnothing$  of 4-32 mm

**Made in Germany**

HAZET No.	mm	EAN-No. 4000896+
2191-2	4– 32	013814

### Base Block



- For "E", "F" and 180° flares 4.75 up to 10 mm

**Made in Germany**

HAZET No.	$\varnothing$ mm	EAN-No. 4000896+
2191-3	4.75– 10	013821

### Thrust Block



- For "E" and "F" flares
  - Surface: burnished
- Made in Germany**

HAZET No.	$\varnothing$ mm	EAN-No. 4000896+
2191- 4	4,8	013838
2191- 5	5	013845
2191- 6	6	013852
2191- 8	8	013869
2191- 9	9	013876
2191-10	10	013807

### Thrust Block



- For "E" and simple flares 4.75 up to 10 mm
- Surface: burnished

**Made in Germany**

HAZET No.	$\varnothing$ mm	mm	EAN-No. 4000896+
2191-90	4.75– 10	( $\frac{3}{16}$ "– $\frac{3}{8}$ " )	013883

### Tube Flaring Tool Set



In sheet metal box

- Especially for **plastic-coated brake lines 4.75 mm  $\varnothing$**
- **Set of 4 pieces**

Contents:

- 2181-1 Tube Cutter
- 2193 A Tube Flaring Unit
- 2193-1 Bending Tool
- 2193-2 Tube Deburring Tool

**Made in Germany**

Contents:

- 2181-1 2193 A 2193-1 2

HAZET No.	EAN-No. 4000896+
2193/4 K	014088

### Tube Flaring Unit



- Light-weight
- Especially for F-flares on plastic-coated brake lines  $\varnothing$  4.75 mm
- May be clamped into a vice, also allows manual operation under vehicles

**Made in Germany**

HAZET No.	$\varnothing$ mm	EAN-No. 4000896+
2193 A	4.8	142538

### Replacement Thrust Block

- With dowel pin

**Made in Germany**

HAZET No.	EAN-No. 4000896+
2193/02	014071

### Bending Tool



- For bending brake lines with a  $\varnothing$  of 4.75 mm
- **Made in Germany**

HAZET No.	$\varnothing$ mm	EAN-No. 4000896+
2193-1	4.8	014057

### Tube Deburring Tool



- For inside and outside deburring of tubes
- **Made in Germany**

HAZET No.	$\varnothing$ mm	EAN-No. 4000896+
2193-2	4.8	014064

### Brake Calliper File



- **Extra slim style (width 10 mm), especially appropriate for Japanese vehicles**
- For removal of brake dust, rust and dirt from the brake calliper
- With integrated **flat scraper** at the front end for removing crude residues

HAZET No.	$l_1$ mm	$l_2$ mm	EAN-No. 4000896+
4968-5	155	265	129379

### Brake Calliper Brush



- For removal of brake dust and dirt from the brake calliper
- For vehicles with disc brakes
- Slim design
- Plastic handle with suspension hole
- **Made in Germany**

HAZET No.	$l$ mm	EAN-No. 4000896+
4968-2	225	084821

### Brass Brake Calliper Brush



- For cleaning **aluminium brake callipers**
- Soft brass bristles facilitate damage-free cleaning
- Slim design – allows working in areas with restricted access
- Plastic handle with suspension hole
- **Made in Germany**

HAZET No.	$l$ mm	EAN-No. 4000896+
4968-3	225	089147

### Brake Calliper File



- **Width: 12 mm**
- For removal of brake dust, rust and dirt from the brake calliper
- For vehicles with disc brakes
- Coarse bevel cut on one side
- One-sided cut prevents damage of the dust boot at the brake piston
- Plastic handle

HAZET No.	$l_1$ mm	$l_2$ mm	EAN-No. 4000896+
4968-1	165	275	084739

### Brake Adjusting Lever



- For adjusting of **drum brake shoes** with excenter
- For adjusting hand brakes with excenter
- Surface: chrome-plated
- **Made in Germany**

HAZET No.	$l$ mm	EAN-No. 4000896+
2582	304	017027

### Hand Brake Tool



- For installing and removing fixing springs of the hand brake shoes on disc brakes
- With T-handle
- With guide groove

HAZET No.	$l$ mm	EAN-No. 4000896+
2730	142	017423

### Brake Fluid Tester



- **User guidance in 7 languages** on the display: D, GB, F, E, NL, P, TR
- **Portable** (for everywhere use) – to be connected to battery, replaces a stationary installation
- **Boiling point tester** – higher testing accuracy in comparison to other testing methods
- **Easy application** – in most vehicles, brake fluid remains in its fluid reservoir
- **Time saving** – the test can be carried out directly in the fluid reservoir
- **Security for the user** – no fluid loss (environmentally sound)
- Approved by vehicle manufacturers
- Approved by TÜV Austria
- **DOT 3, DOT 4, DOT 5.1 brake fluid**
- Measuring temperature up to 320° C (608° F)
- Operating voltage 12 V

HAZET No.	EAN-No. 4000896+
4954-1	129201

### Calliper Gauge for Brake Discs



- For measuring the thickness of the brake discs (wear/abrasion of the brake disc)
- Follow vehicle manufacturer's instructions!
- With fixing screw and sliding vernier (vernier 1/10)
- With crowned measuring surfaces
- In leather case
- **Made in Germany**

HAZET No.	EAN-No. 4000896+
4956-1	073160

- For passenger cars and motorcycles
  - Measuring range up to 60 mm
  - Jaw length 75 mm
  - For commercial vehicles, measuring range 100 mm, Jaw length 115 mm
- |        |        |
|--------|--------|
| 4956-2 | 073177 |
|--------|--------|





## Calliper Gauge for Brake Drums



- For the abrasion test at the drum brakes of passenger cars and commercial vehicles (follow vehicle manufacturer's instructions)
- Scale and slide made of aluminium profile
- Jaws made of stainless steel, 150 mm long
- Inside measuring with immediate reading
- Vernier  $\frac{1}{20}$
- With fixing screw
- Measuring range up to 500 mm
- In wooden box

**Made in Germany**

HAZET No.	EAN-No. 4000896+
4955-1	073153

## Brake Test Tool Set



**For checking the lateral run-out of the brake disc**

**Contents:**

- 1 micrometer screw for exact determination of the thickness of the brake disc
- 1 precision dial gauge for checking the lateral run-out
- 1 hinged bracket with magnetic base as mounting and for an exact positioning of the dial gauge to the vehicle
- **Set of 3 pieces in high-quality plastic case with soft foam insert**

HAZET No.	EAN-No. 4000896+
4968/3	149179

## Brake Bleeding Valve Tool

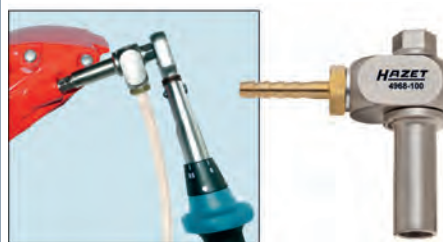

- Simple tool for the tight connection of filling and bleeding sets, such as 4969-1/3 to the brake bleeding valve
- Application of common vacuum filling and bleeding systems possible
- Hose connection: 6 mm inside diameter
- For operation and controlled screw tightening use a torque wrench with  $\frac{1}{4}$ " drive 6.3 mm =  $\frac{1}{4}$ " e.g. HAZET 5108-2 CT
- Integrated non-return valve, non-drip

**Made in Germany**

HAZET No.	EAN-No. 4000896+
4968-100	159857

## Pneumatic Brake Fluid Bleeder Set



**Brake Fluid Bleeder for the extraction of brake fluid on wheel brake cylinders/brake callipers**

**Brake Fluid Bleeder for the extraction of brake fluid on wheel brake cylinders/brake callipers**

- Also suitable for ABS brakes (Caution: **Always follow manufacturer's specifications**)
- By means of compressed air, the integrated Venturi-system creates a vacuum, enabling thus the bleeding of the brake system
- With universal plastic nozzle, suitable for all common vehicle types
- Clear transparent brake fluid hose enables easy visual check
- Air consumption: 180 l/min/Working pressure: 6 to 8 bar
- Coupler plug, nominal size 7.2 included
- Contents:
  - 1 brake fluid bleeder (container capacity 0.75 l)
  - 1 refill container with fix nozzle
  - 1 refill container with flexible nozzle (container capacity: 1 litre each)

HAZET No.	EAN-No. 4000896+
4969-1/3	149445

## Brake Piston Readjusting Set



### Application

**Brake Piston Readjusting Sets**  
www.hazet.de → Online-Katalog  
→ Bremskolben-Rücksetz-Sets  
◀ For Smartphones with QR-Reader (App)

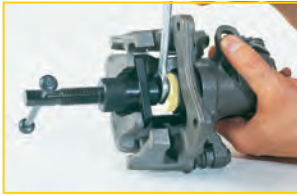

Optional		
4970-10	4970-11	4970-12

### With thrust bearing rotating to the left and right

- For readjusting (**pushing or turning**) brake pistons on floating calliper systems with or without locking device for hand brakes
- Thrust bearing avoids damaging of the dust boot
- With additional outside hexagon  $s \approx 13$  mm for flexible application of operating tools, e.g. reversible ratchets
- Universal application – suitable for all common vehicle types

**Made in Germany**

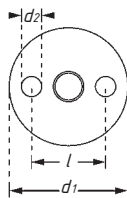

HAZET No.	$d_1$ mm	$d_2$ mm	EAN-No. 4000896+
<b>Set of 6 pieces in plastic case</b>			
Contents:			
4970-1 5 6 7 8 9			
<b>4970/6</b>	-	-	088867
<b>Set of 9 pieces in plastic case</b>			
Contents:			
4970-1 5 6 7 8 9 10 11 12			
<b>4970/9</b>	-	-	157464
<b>Basic appliance</b>			
<b>4970-1</b>	-	-	088874

### Set of 6 pieces in plastic case

Contents:

4970-1 5 6 7 8 9

**4970/6** - - 088867

### Set of 9 pieces in plastic case

Contents:

4970-1 5 6 7 8 9 10 11 12

**4970/9** - - 157464

### Basic appliance

**4970-1** - - 088874

### Adapter with 2 pins for:

**AUDI** A4 since 2004 and since 2007, A6 since 1997, 100 since 1993, 80, B4, **VW** Golf 3 since 1997, Golf 4, Golf 5 since 2004, New Beetle since 2006, Passat since 2002, Polo since 2004, T4 since 1998, Polo 6N since 1998, T5 since 2004, **OPEL** Astra H since 2007, Astra GTC since 2005, Zafira. 1999-2005, Zafira since 2005, **FORD** Galaxy since 2003, Transit since 2007, **PEUGEOT** 307 SW since 2002, 407, **CITROËN** C4 since 2008, C5 since 2006, Xsara since 2002 **ALFA** 156 since 2004, 147 year 2005, year 2008, 166 since 2004, **RENAULT** Traffic since 2005, Espace since 2000, **SEAT** Leon since 2001, Ibiza since 2003, Altea since 2004, Toledo since 2001, **SKODA** Octavia since 2007, Fabia since 2004, **FIAT** Croma since 2006, Croma since 2008

**4970-5** 35 5 052943

### Adapter VW-AUDI inside hexagon 12 mm

**4970-6** 30 - 052950

### Adapter with 2 pins for:

**FORD** Focus (-2003), Mondeo since 2001, **OPEL** Astra G, Corsa GSI, **SMART** For Four, **MAZDA** 6 since 2003, **RENAULT** Kangoo 4x4 since 2005, **ALFA** Spider since 1998, **TOYOTA** Corolla since 2000

**4970-7** 32 6 052967

### Adapter with 2 pins for:

**CITROËN, VW, AUDI**

**4970-8** 55 6 052974

### Adapter with 4 pins for:

**HONDA** Jazz since 2006, **FORD** Mondeo since 1997, Mondeo since 2000, Focus since 2004, **SAAB**, **RENAULT** Megané since 2001, Scénic since 2001, Scénic 2, **ROVER** 214i rear, **VW** GOLF 4, Polo since 2003, **NISSAN** Almera, **OPEL** Tigra B since 2007

**4970-9** 30 5 052981

### Adapter with 2 pins for

**OPEL** Vectra C, **RENAULT** Scenic since 2005 consider brake calliper execution

**4970-10** 35 6 126019

## Brake Piston Readjusting Set



HAZET No.	$d_1$ mm	$d_2$ mm	EAN-No. 4000896+
<b>Adapter with 2 pins for:</b>			
<b>FIAT</b> Panda 4x4 since 2006, <b>RENAULT</b> Espace since 2004, Vel Satis since 2002, Laguna 2, <b>OPEL</b> Vectra C consider brake calliper execution			
<b>4970-11</b>	35	3	146581
<b>Adapter with 2 pins for:</b>			
<b>FORD</b> rear wheel brake: Focus since 2005, C-Max since 2003, Mondeo, S-Max since 2006, <b>KIA</b> Sorento			
<b>4970-12</b>	40	5	149766

## Brake Piston Readjusting Tool



### For damage-free readjusting brake pistons (floating callipers/fixed callipers) on disc brakes

- Suitable for all common vehicle types without integrated locking device for hand brakes
- Fast and uniform readjusting without tilting
- Avoids damaging of the boots and pistons
- High accuracy as well as high stability allow continuous use
- Reduced expenditure of force due to exact guidings

**Made in Germany**

HAZET No.	EAN-No. 4000896+
<b>4971-1</b>	156245

## Brake Spring Pliers



- For installing and removing the brake shoe recuperating spring on **riveted brake linings**
- Surface: chrome-plated

**Made in Germany**

HAZET No.	l mm	EAN-No. 4000896+
<b>796</b>	215	031818



- For **glued and riveted brake linings**
- With movable claw
- Surface: chrome-plated

**Made in Germany**

HAZET No.	l mm	EAN-No. 4000896+
<b>797</b>	317	031825

## Lockring Pliers



- For the operation of **deeply located lockrings** e.g. on calipers and gear boxes
- With long bent jaws (90°)
- Ergonomically shaped **2-component plastic handle covers**
- Surface: chrome-plated

**Made in Germany**

HAZET No.	l mm	mm	EAN-No. 4000896+
<b>1846 b-1.6</b>	195	1.6	061457





# Chassis

Tools for the following fields of application:

- ✓ Spring Vice / Shock Absorbers
- ✓ Wheel Bearing / Wheel Hub
- ✓ Silent Block
- ✓ Cardan Shafts
- ✓ Wheels / Tyres

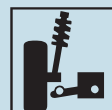

# HAZET – Safety Spring Vice 4900

... everything fits well and your safety is guaranteed.

**CLIP**  
WWW



- ✓ Suitable for approx. 200 vehicle types
- ✓ High capacity of 26,000 N
- ✓ Suitable for impact wrenches
- ✓ Closed system – maintenance-free
- ✓ Proven safety
- ✓ With location bar for machinist's vice
- ✓ **Made in Germany**



Chassis



## Classification list

Suitable for approx. 200 vehicle types

Federeinheiten-Datenbank									
Hersteller: CHRYSLER									
Suchen									
Modell	Motor	Strom	Druck	Druck	Druck	Druck	Druck	Druck	Druck
1500 CAS	1500	4800-12	200	4800-11	200				
Chrysler (J4)	1500	4800-12	200	4800-11	200				
Grand Cherokee	2.0i, 4x4	4800-11	200	4800-12	200				

For Smartphones with QR-Reader (App)



Federeinheiten-Datenbank									
Hersteller: PEUGEOT									
Suchen									
Modell	Motor	Strom	Druck	Druck	Druck	Druck	Druck	Druck	Druck
100	1000	4800-12	200	4800-11	200				
200	1500	4800-12	200	4800-11	200				
200	1500	4800-12	200	4800-11	200				
400	1500	4800-12	200	4800-11	200				
500	1500	4800-12	200	4800-11	200				
600	1500	4800-12	200	4800-11	200				
800	1500	4800-12	200	4800-11	200				
Blazer	200	4800-12	200	4800-11	200				

Updated table in the internet  
www.hazet.de  
Online-Katalog  
Produktanwendungen  
Federeinheiten-Datenbank  
(German only)

**Products**  
see pages 231 to 233  
**Application charts**  
see pages 234 to 239





# Safety Spring Vice Basic Appliance



## Application

### Safety Spring Vice

www.hazet.de → Online-Katalog → Produktanwendungen  
Federspanner-Datenbank

← For Smartphones with QR-Reader (App)

For installing and removing the coil spring when changing shock absorbers  
Suitable for approx. 180 different vehicle types

- Max. span 309 mm
- High capacity of 26000 N
- Suitable for impact operation, e.g. HAZET 9012 MG in conjunction with impact socket HAZET 900 S-27 or 900 S Lg-27
- Closed system – maintenance-free!
- Variable system due to easily replaceable tensioning jaws
- Plastic inserts for the protection of the lacquered spring surfaces preventing coil damage due to corrosion.
- With location bar for machinist's vice
- GS mark – Tested Safety
- Tempered cylindrical and guiding tube
- Forged and tempered tensioning jaws
- Also suitable for spring struts with stop spring in the shock absorber
- No need of further specialty tools

Classification to vehicles see table or in the internet:

www.hazet.de → Produkte → Produktanwendungen → Federspanner-Datenbank

**Made in Germany**

<b>HAZET</b> No.	EAN-No. 4000896+
4900-2 A	077267



Replacement set for Spring Vice 4900-1 A and -2 A consisting of 2 straight pins and 1 O-ring

4900-02 A/3	069415
-------------	--------

Replacement set for Spring Vice 4900-1 and 4900-2 consisting of: 5 straight pins and 2 O-rings

4900-02/7	063437
-----------	--------



# Safety Spring Vice Set



Set with 3 pieces, 4900-2 A/3: suitable for approx. 50 different vehicle types

Set with 5 pieces, 4900-2 A/5: suitable for approx. 100 different vehicle types.

– Refer to table "Classification to vehicles" in the Internet: www.hazet.de or from page 234 on



For installing and removing the coil spring when replacing shock absorbers

- Suitable for impact wrenches
- Closed system – maintenance-free!
- Variable system due to easily replaceable tensioning jaws
- Plastic inserts for the protection of the lacquered spring surfaces preventing coil damage due to corrosion.
- With location bar for machinist's vice
- 4900-2 A also suitable for spring struts with stop spring in the shock absorber
- No need of further specialty tools
- Max. span: 309 mm
- High capacity of 26000 N
- GS mark – Tested Safety
- Tempered cylindrical and guiding tube
- Forged and tempered tensioning jaws

**Made in Germany**

<b>HAZET</b> No.	EAN-No. 4000896+
1 Basic Appliance and 2 Tensioning Jaws 4900-11 Suitable for approx. 50 different vehicle types 4900-2 A/3	149483

1 Basic Appliance and 4 Tensioning Jaws (2x 4900-11 and 2x 4900-12). Suitable for approx. 100 different vehicle types 4900-2 A/5	086054
--	--------

Federspanner-Datenbank

Hersteller: PEUGEOT

Suchen

PEUGEOT

Fahrzeug-Typ	Modell	Spannweite	Konstr. Einlage	Spannweite	Konstr. Einlage	Weitere Anwendung
Jeep (S)	-1994	4900-12 (D)	-	4900-11 (D)	-	
Chrysler (K)	-1993	4900-11 (D)	-	-	-	
Grand Cherokee (Z) 25, WJ	-1993	4900-11 (D)	-	-	-	
Neon (PL)	-1997	4900-12 (D)	-	4900-11 (D)	-	
Stratus (L) LX	-1996	4900-16 (D)	-	-	-	
Voyager (G)	-1996	4900-13 (D)	-	-	-	
Wenger (T)	-1997	4900-11 (D)	-	-	-	

Hersteller vorhanden

Bung mit entspr. Kunststoffeinlagen verwenden, insbesondere bei Belägen.

Technische Änderungen der Fahrzeughersteller vorbehalten

- = keine Federspanner mitbewilligt  
\* = 2, 3: keine Informationen vorhanden  
\*\* = BMW-Schraubentzähner nur in Verbindung mit entspr. Kunststoffeinlagen verwenden.  
BMW-Vorschrift: Federspanner nur mit Handwerkzeugen betätigen.

**Tensioning Jaw (Price per piece)**  
Application see classification table



**Made in Germany**

HAZET No.	EAN-No. 4000896+
4900-10	059706

**Plastic Spring Protection Insert**  
4900-100 061136



**Made in Germany**

HAZET No.	EAN-No. 4000896+
4900-11	059713

**Plastic Spring Protection Insert**  
4900-110 061143



**Made in Germany**

HAZET No.	EAN-No. 4000896+
4900-12	059720

**Plastic Spring Protection Insert**  
4900-120 061150



**Made in Germany**

HAZET No.	EAN-No. 4000896+
4900-13	059737

**Plastic Spring Protection Insert**  
4900-130 061167



**Made in Germany**

HAZET No.	EAN-No. 4000896+
4900-14 A	064649

**Tensioning Jaw (Price per piece)**  
Application see classification table



**Made in Germany**

HAZET No.	EAN-No. 4000896+
4900-15 A	121472



**Made in Germany**

HAZET No.	EAN-No. 4000896+
4900-16	062164



**Made in Germany**

HAZET No.	EAN-No. 4000896+
4900-17	062171



**Made in Germany**

HAZET No.	EAN-No. 4000896+
4900-18	100378

**Plastic Spring Protection Insert**  
4900-180 074327



**Made in Germany**

HAZET No.	EAN-No. 4000896+
4900-19	085842



**Made in Germany**

HAZET No.	EAN-No. 4000896+
4900-22	062188

**Tensioning Jaw (Price per piece)**  
Application see classification table



**Made in Germany**

HAZET No.	EAN-No. 4000896+
4900-23	062195

**Plastic Spring Protection Insert**  
4900-230 061020

**Plastic Spring Protection Insert**

- Special insert in conjunction with HAZET Tensioning Jaws 4900-23 and Safety Spring Vice 4900-2\*A
- For the operation of the front axle springs on **BMW** since 2001  
E65: 735i, 745i, 730d, 740d  
E66: 7

4900-231	088959
----------	--------



**Made in Germany**

HAZET No.	EAN-No. 4000896+
4900-24	062201

**Spacer Ring for the Tensioning Jaw 4900-24**

- Especially advantageous if HAZET 4900-22 and -24 already exists

4900-243	162932
----------	--------



**Made in Germany**

HAZET No.	EAN-No. 4000896+
4900-25	121670

- For driver's cabin with steel springs **MERCEDES-BENZ Actros (MP-1)** since 1996, Atego since 1998



**Made in Germany**

HAZET No.	EAN-No. 4000896+
4900-26	121687

- For driver's cabin with steel springs **MERCEDES-BENZ Actros (MP-1)** since 1996, Atego since 1998





## Specialty Tools – Chassis – Spring Vice / Shock Absorber

### Tensioning Jaw (Price per piece)

Application see classification table



**Made in Germany**

HAZET No.	EAN-No. 4000896+
4900-28	100545

#### Plastic Plugs

- Plastic plugs for the codification of the tensioning jaws as well as for the prevention of damage at the threads of the strut mounting

4900-28/06	100484
------------	--------



**Made in Germany**

HAZET No.	EAN-No. 4000896+
4900-29	100538

#### Plastic Plugs

- Plastic plugs for the codification of the tensioning jaws as well as for the prevention of damage at the threads of the strut mounting

4900-29/02	127566
------------	--------

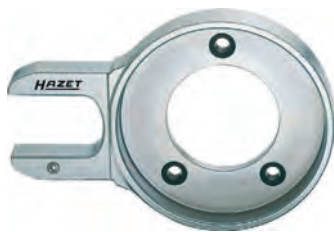

**Made in Germany**

HAZET No.	EAN-No. 4000896+
4900-30	100514



**Made in Germany**

HAZET No.	EAN-No. 4000896+
4900-31	138036

Plastic Spring Protection Insert for Tensioning Jaw 4900-31

4900-310	167715
----------	--------

### Tensioning Jaw (Price per piece)

Application see classification table



**Made in Germany**

HAZET No.	EAN-No. 4000896+
4900-33	138043



**Made in Germany**

HAZET No.	EAN-No. 4000896+
4900-34	121731



**Made in Germany**

HAZET No.	EAN-No. 4000896+
4900-35	121212

### MERCEDES-BENZ Tensioning Jaw Set



#### With brake

- For the operation of the coil springs of the front axle on **MERCEDES-BENZ**, type 204 (C-Class), type X 204 (GLK-Class), type 212 (E-Class with standard chassis)/ type 212 (E-Class with sports chassis)
- To be used together with HAZET Safety Spring Vice 4900-2 A
- Enables safe positioning of the spring struts with pivot bearing
- To be used together with HAZET Safety Spring Vice 4900-2 A, suitable tensioning jaw, e.g. 4900-17 and suitable centring insert (choose according to vehicle type. Note: Please follow the instructions of the manufacturer!)

**Made in Germany**

HAZET No.	EAN-No. 4000896+
4900-39/11	167678

#### Centring Insert for MERCEDES-BENZ, type 204 (C-Class)

- To be used with HAZET Safety Spring Vice 4900-2 A, Tensioning Jaw 4900-17 as well as Round Tensioning Jaw with Brake 4900-39/11

4900-393	167722
----------	--------

#### Centring Insert for MERCEDES-BENZ, type X204 (GLK-Class)

- To be used with HAZET Safety Spring Vice 4900-2 A, Tensioning Jaw 4900-17 and Plastic Spring Protection Insert 4900-120 as well as Round Tensioning Jaw with Brake 4900-39/11

4900-394	167739
----------	--------

#### Centring Insert for MERCEDES-BENZ, type 212 (E-Class) with standard chassis

- To be used with HAZET Safety Spring Vice 4900-2 A, Tensioning Jaw 4900-31 and Plastic Spring Protection Insert 4900-310 as well as Round Tensioning Jaw with Brake 4900-39/11

4900-395	167746
----------	--------

#### Centring Insert for MERCEDES-BENZ, type 212 (E-Class) with sports chassis

- To be used with HAZET Safety Spring Vice 4900-2 A, Tensioning Jaw 4900-17 as well as Round Tensioning Jaw with Brake 4900-39/11

4900-396	167753
----------	--------

# HAZET – everything fits well – and your safety is guaranteed!



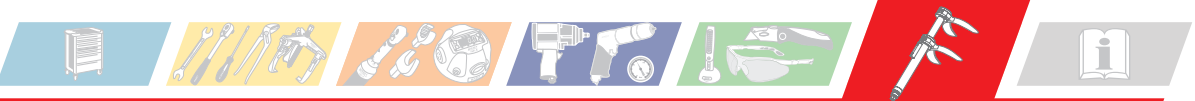

## Classification examples:

For more information see [www.hazet.de](http://www.hazet.de) in the internet:

















































[www.hazet.de](http://www.hazet.de) → Online-Katalog → Produktanwendungen → Federspanner-Datenbank (German only)

**Technical modifications of the vehicle manufacturers are subject to change without notice**

\* = no information available.

\*\* = Use on BMW coil springs only in conjunction with the corresponding plastic spring protection inserts. BMW prescription: Spring vices must be operated with hand tools only!















































 Type	 Model Year	Tensioning Jaws		Plastic Spring Protection Inserts / Centring Inserts	Tensioning Jaws		Plastic Spring Protection Inserts / Centring Inserts
<b>ALFA ROMEO</b>							
Alfa 147	2003	4900-11 (2x)			4900-11 (2x)		
Alfa 156	1998-	4900-10 (2x)		*	*		*
Alfa 164 Super	1996	4900-13 (2x)		*	*		*
Mito	2009	4900-11 (2x)			4900-11 (2x)		
<b>AUDI</b>							
100 Quattro	1989-1993	4900-13 (2x)		*	4900-11 12		*
100C4	1989-1993	4900-13 (2x)		*	4900-11 (2x)		*
80	1989	4900-11 (2x)		*	*		*
80B4	1992	4900-11 (2x)		*	*		*
A100	1991	4900-13 (2x)		*	*		*
A2	2000	4900-11 (2x)		*	*		*
A3	2000-	4900-11 (2x)		*	4900-10 (2x)		*
A4	1996	4900-11 (2x)		*	*		*
A4 Vario	1996	4900-11 (2x)		*	*		*
A5	2007-	4900-12 (2x)		*	*		*
A6	1996	4900-11 (2x)		*	*		*
A8	1996	4900-11 (2x)		*	*		*
<b>BMW</b>							
1 (E87) **: 116i / 118i / 120i / 118d / 120d	2004-	4900-11 (2x)		4900-110 (2x)	4902/6		-
3 (E36) **	1989-1998	4900-12 (2x)		4900-120 (2x)	*		*
3 (E46) **	1998-	4900-22 24		4900-220 240	*		-
3 (E90) **: 320i / 325i / 330i / 320d Limousine	2004-	4900-22 24		4900-243	4902/6		-
3 (E91) **: 320 / 325 / 330 / Touring	2005-	4900-22 24		4900-243	4902/6		-
3 (E92): 320 / 323 / 325 / 328 / 330 / 335	2005-	4900-22 24		4900-243			
3 (E93): 320 / 325 / 328 / 330 / 335	2006-	4900-22 24		4900-243			
5 (E60) **	2004-	4900-22 24		4900-220	*		*
5 (E34) **	1994	4900-11 (2x)		4900-110 (2x)	*		*
5 (E39) **: 528i	1995-2000	4900-12 (2x)		4900-120 (2x)	*		*
5 (E39) **: 530i / 540i	1996-	4900-23 (2x)		4900-230 (2x)	*		*
7 (E32) **: 730i	1986-1994	4900-11 (2x)		4900-110 (2x)	*		*
7 (E38) **	1993-2000	4900-23 (2x)		4900-230 (2x)	*		*
7 (E65) **: 735i / 745i / 730d / 740d	2001-	4900-23 (2x)		4900-231 (2x)	4900-19 (2x)		4900-190 (2x)
7 (E66) **: 735Li / 745Li	2001-	4900-23 (2x)		4900-231 (2x)	4900-19 (2x)		4900-190 (2x)
Mini	2001	4900-11 (2x)			4900-10 11		
X3 (E83)	2006-	4900-31 33					













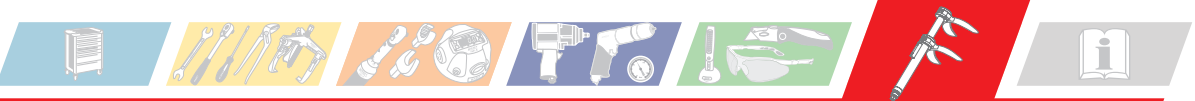









































## Specialty Tools – Chassis – Spring Vice / Shock Absorber

Ingenious Tools

 Type	 Model Year	Tensioning Jaws		Plastic Spring Protection Inserts / Centring Inserts	Tensioning Jaws		Plastic Spring Protection Inserts / Centring Inserts
<b>BMW</b>							
X5 (E70)	2006	4900-10 11		4900-100 110			
Z3 **	1996-	4900-12 (2x)		4900-120 (2x)	*		*
<b>CHRYSLER</b>							
300M (LH)	1998-	4900-12 (2x)		*	4900-11 (2x)		*
Cherokee (XJ)	1993-	4900-11 (2x)		*	*		*
Grand Cherokee (ZJ, ZG, WJ)	1993-	4900-11 (2x)		*	*		*
Neon (PL)	1997-	4900-12 (2x)		*	4900-17 (2x)		*
Stratus (JA/JX)	1996-	4900-16 (2x)		*	*		*
Voyager (GS)	1996-	4900-13 (2x)		*	*		*
Wrangler (TJ)	1997-	4900-11 (2x)		*	*		*
<b>CITROËN</b>							
Jumper	1997-	4900-13 (2x)		*	*		*
Nemo	2008	4900-11 (2x)			4900-11 (2x)		
ZX	1996	4900-12 (2x)					
<b>DACIA</b>							
Logan 1,6i	2005-	4900-11 (2x)		*	*		*
<b>DAEWOO</b>							
Nexia	1997	4900-11 (2x)		*	*		*
Nubira	1998-	4900-11 (2x)		*	*		*
<b>FIAT</b>							
Barchetta	1995	4900-12 (2x)		*	*		*
Ducato	1995	4900-13 (2x)		*	4900-13 (2x)		*
Ducato	2006	4900-13 (2x)					
Doblo	2010	4900-11 (2x)			4900-11 (2x)		
Grande Punto	2005-	4900-11 (2x)		*	4900-11 (2x)		*
Marea	1997	4900-13 (2x)		*	*		*
Panda	1993	4900-10 (2x)		*	*		*
Punto	1997	4900-10 12		*	*		*
Qubo	2009	4900-12 (2x)			4900-12 (2x)		
Seicento Sporting	1998	4900-12 (2x)		*	*		*
Stilo	2002	4900-11 (2x)		*	*		*
Tempra	1993	4900-12 (2x)		*	*		*
Tipo	1990	4900-13 (2x)		*	*		*
Ulysse	1994	4900-13 (2x)		*	*		*
<b>FORD</b>							
C-Max	2006	4900-12 (2x)					
Escort	1988	4900-10 (2x)		*	*		*
Escort 1,4i	1988	4900-10 (2x)		*	*		*
Fiesta	1989-1995	4900-10 (2x)		*	4900-10 (2x)		*
Fiesta	1996	4900-11 (2x)		*	*		*

Chassis



























































 Type	 Model Year	Tensioning Jaws		Plastic Spring Protection Inserts / Centring Inserts	Tensioning Jaws		Plastic Spring Protection Inserts / Centring Inserts
<b>FORD</b>							
Fiesta	2008	4900-11 (2x)					
Fiesta	2009	4900-12 (2x)					
Fiesta	2005	4900-11 (2x)					
Focus	1998	4900-11 (2x)		*	*		*
Focus	2004	4900-12 (2x)			4900-10 (2x)		
Focus	2007	4900-12 (2x)					
Fusion	2005	4900-11 (2x)					
Ka	1996-2008	4900-11 (2x)					
Ka	1998				4900-10 (2x)		
Ka	2001				4900-10 (2x)		
Mondeo	1996	4900-12 (2x)		*	4900-11 12		*
Mondeo	2001	4900-12 (2x)			4900-11 (2x)		
Mondeo	2008	4900-12 (2x)					
Puma	1998-	4900-11 (2x)		*	4900-10 (2x)		*
Sierra	1991	4900-11 (2x)		*	*		*
S-Max	2006	4900-11 (2x)					
<b>HONDA</b>							
Accord Coupé		4900-12 (2x)		*	4900-12 (2x)		*
<b>ISUZU</b>							
Gemini	1988	4900-11 (2x)		*	*		*
<b>MAZDA</b>							
626	1992	4900-13 (2x)		*	4900-11 (2x)		*
<b>MERCEDES-BENZ</b>							
A-Class Type 168	1997-2004	4900-15 A (2x)		*	4900-14 A (2x)		*
A-Class Type 169	2004-	4900-17 (2x)		*	4900-35 (2x)		*
Actros (MP-1) Commercial Vehicle	1996-	Special-Application: Driver's cabin 4900-25 26 					
Atego Commercial Vehicle	1998-	Special-Application: Driver's cabin 4900-25 26 					
B-Class Type 245	2005	4900-17 (2x)			4900-35 (2x)		
C-Class / Type 203	2000-	4900-17 18		4900-180	*		*
C-Class / Type 204	2007-	4900-39/11 17		4900-393			
GLK-Class/Type X204	2008-	4900-39/11 17		4900-394 120			
E-Class /Type 212	2009-	4900-39/11 31		4900-395 310			
E-Class/Type 212 sports chassis	2009-	4900-39/11 17		4900-396			
E- Class Type 211 / Type 219	2003-	4900-19 30		*	*		*
E-Class 4MATIC / Type 210	1997-2002	4900-14 A (2x)		*	*		*
ML- Class Type 164	2005-	4900-35 (2x)		*	*		*
ML-Class / Type 163	1997-2005	*		*	4900-16 (2x)		*
SL-Class / Type 230	2003-	4900-19 28		*	4900-19 29		*
SLK / Type 171	2004-	4900-18 34		4900-180	*		*
Vito, V-Class / Type 638	1996-2002	4900-17 (2x)		*	*		*





Type	Model Year	Tensioning Jaws		Plastic Spring Protection Inserts / Centring Inserts	Tensioning Jaws		Plastic Spring Protection Inserts / Centring Inserts
<b>MERCEDES-BENZ</b>							
Vito/Viano Type 639	2003-	4900-23 (2x)		4900-230 (2x)	*		*
<b>NISSAN</b>							
Almera (N15)	1996	4900-11 (2x)		*	4900-10 (2x)		*
Bluebird (T12)	1985-1990	4900-13 (2x)		*	4900-12 (2x)		*
Laurel (C32)	1984-1990	4900-12 (2x)		*	4900-10 (2x)		*
Micra (K10)	1982-1992	4900-10 (2x)		*	4900-10 (2x)		*
Micra (K11)	1992-	4900-10 (2x)		*	*		*
N200SX (S14)	1994	4900-13 (2x)		*	4900-11 (2x)		*
Prarie (M11)	1992-	4900-13 (2x)		*	4900-13 (2x)		*
Primera (P11)	1996	4900-10 11		*	4900-10 (2x)		*
Primera (W10)	1990	4900-11 (2x)		*	*		*
Serena (C23)	*	4900-13 (2x)		*	*		*
<b>OPEL</b>							
Ascona C	1989	4900-12 (2x)		*	*		*
Astra F	1991-1998	4900-11 (2x)		*	*		*
Astra G	1998-1999	4900-11 (2x)		*	4900-11 (2x)		*
Astra H	2004-	4900-12 (2x)		*	*		*
Calibra A	1994	4900-12 (2x)		*	*		*
Corsa A	1987	4900-11 (2x)		*	*		*
Corsa B	1997	4900-11 (2x)		*	*		*
Corsa D	2006	4900-11 (2x)		*	4900-10		*
Kadett E	1989	4900-11 (2x)		*	*		*
Omega A	1987	4900-12 (2x)		*	*		*
Omega B	1997	4900-12 (2x)		*	*		*
Sintra	1998	4900-12 (2x)		*	*		*
Tigra	1996	4900-11 (2x)		*	4900-11 (2x)		*
Vectra A	1994	4900-12 (2x)		*	*		*
Vectra B	1996-	4900-12 (2x)		*	*		*
Vectra C	2004-	4900-12 (2x)		*	*		*
Zafira	1999-	4900-12 (2x)		*	*		*
<b>PEUGEOT</b>							
106	1997	4900-12 (2x)		*	*		*
205	1989	4900-12 (2x)		*	*		*
206	1992	4900-12 (2x)		*	*		*
307 SW		4900-11 (2x)		*	4900-12 (2x)		*
406	1997	4900-12 (2x)		*	*		*
505	1983	4900-12 (2x)		*	*		*
806	1999	4900-13 (2x)		*	4900-11 (2x)		*
Boxer	*	4900-13 (2x)		*	*		*
Partners		4900-12 (2x)		*	4900-12 (2x)		*

 Type	 Model Year	Tensioning Jaws		Plastic Spring Protection Inserts / Centring Inserts	Tensioning Jaws		Plastic Spring Protection Inserts / Centring Inserts
<b>PORSCHE</b>							
911 Carrera RS (Type 993)	1995-	4900-16 (2x) 	*		4900-14 A (2x) 	*	
911 Turbo / Carrera 2 / 4 (Type 964)	1989-1993	4900-16 (2x) 	*		4900-14 A (2x) 	*	
911 Turbo / Carrera 2 / 4 (Type 993)	1993-1998	4900-16 (2x) 	*		4900-16 (2x) 	*	
924 S	1982-1991	4900-10 (2x) 	*		*	*	
928 / 928 S / 928 S4 / 928 GTS	1978-1995	4900-15 A (2x) 	*		4900-15 A (2x) 	*	
944 / 944 S / 944 S2 / 944 Turbo	1982-1991	4900-10 (2x) 	*		*	*	
968	1992-1995	4900-10 (2x) 	*		*	*	
Boxster/Boxster S (Type 986)	1996-2004	4900-15 A 22 	*		4900-11 (2x) 	*	
Boxster/Boxster S (Type 987)	2004	4900-15 A 22 	*		4900-22 (2x) 	*	
Carrera 2 / 4 (Type 997)	2004	4900-15 A 22 	*		4900-22 (2x) 	*	
Carrera 2 / 4 / Turbo (Type 996)	1998-2004	4900-15 A 22 	*		4900-16 (2x) 	*	
Cayenne	2004-	4900-16 (2x) 	*		4900-16 (2x) 	*	
Cayman	2006-	4900-15 A 22 	*		4900-22 (2x) 	*	
<b>RENAULT</b>							
Clio 2	2001	4900-11 (2x) 					
Clio 3 1,5 dci	2005	4900-12 (2x) 	4900-120 (2x)	*		*	
Espace 2	2004	4900-13 (2x) 			4900-13 (2x) 		
Espace 2,0 turbo	2003	4900-17 (2x) 	*		*	*	
Kangoo 1,5	2004	4900-15 A (2x) 	*		*	*	
Laguna 2,0 dci	2005-	4900-12 (2x) 	*		4900-11 (2x) 	*	
Megane	1996-	4900-12 (2x) 	*		*	*	
Megane 2 1,9dci	2003-	4900-12 (2x) 	4900-120 (2x)	*		*	
Modus 1,5dci	2005-	4900-12 (2x) 	*		*	*	
R19	1990	4900-12 (2x) 	*		*	*	
19	1992	4900-12 (2x) 			4900-12 (2x) 		
R21	1991	4900-13 (2x) 	*		*	*	
R5	1992	4900-11 (2x) 	*		*	*	
Rapid	1994	4900-11 (2x) 	*		*	*	
Safrane B544	1998	4900-11 12 					
Scenic 1,5dci	2005-	4900-12 (2x) 	4900-120 (2x)	*		*	
Traffic	2005	4900-11 (2x) 			4900-11 (2x) 		
Twingo 1,2	1998-	4900-11 (2x) 	*		*	*	
<b>SAAB</b>							
93	2002	4900-12 (2x) 			4900-12 (2x) 		
<b>SEAT</b>							
Ibiza	2002	4900-11 (2x) 	*		4900-10 (2x) 	*	
Leon	2002	4900-11 (2x) 	*		4900-10 (2x) 	*	
Toledo	1996	4900-11 (2x) 	*		*	*	
<b>SKODA</b>							
Fabia	2001	4900-11 (2x) 	*		*	*	



**Specialty Tools – Chassis – Spring Vice / Shock Absorber**

Type	Model Year	Tensioning Jaws		Plastic Spring Protection Inserts / Centring Inserts	Tensioning Jaws		Plastic Spring Protection Inserts / Centring Inserts
<b>SKODA</b>							
Oktavia	1999	4900-11 (2x)		*	*		*
Roomster	2007	4900-11 (2x)			4900-11 (2x)		
Superb	2002	4900-11 (2x)		*	*		*
<b>SMART</b>							
fortwo	2009	4900-10 (2x)					
<b>SUZUKI</b>							
Alto	1993	4900-10 (2x)		*	*		*
Ignis	2000	4900-10 (2x)		*	*		*
Wagon R+	2000	4900-10 (2x)		*	*		*
<b>TOYOTA</b>							
Camri 3,0	1992	4900-12 (2x)			*		
Corolla	1999	*			4900-11 12		
Picnic	1996	4900-11 (2x)			*		
<b>VOLKSWAGEN</b>							
Amarok	2010	4900-11 (2x)					
Caddy	2006	4900-11 (2x)					
Golf 1 and 2		4900-10 (2x)			*		
Golf 2 1,3L		4900-10 (2x)			4900-11 (2x)		
Golf 3		4900-11 (2x)			*		
Golf 4	1998	4900-11 (2x)			4900-10 (2x)		
Golf 5	2003-	4900-11 (2x)					
Golf 6	2008	4900-11 (2x)					
Jetta	1989	4900-11 (2x)			*		
Lupo	1999	4900-11 (2x)			4900-10 (2x)		
Lupo	2001	4900-11 (2x)					
Passat B2	1980-1988	4900-11 (2x)			*		
Passat B3	1988-1993	4900-11 (2x)			*		
Passat B4	1993-1997	4900-11 (2x)			4900-10 (2x)		
Passat B5	1996-2005	4900-11 (2x)					
Passat B6	2005-	4900-11 (2x)					
Polo	1994	4900-11 (2x)			*		
Polo	2002	4900-11 (2x)			4900-11 (2x)		
Polo I		4900-11 (2x)			*		
Sharan	1996	*			4900-12 (2x)		
T5 (Transporter) 1,9D and 2,5D		4900-13 (2x)					
Tiguan	2008	4900-11 (2x)					
Touran	2003-	4900-11 (2x)			4900-10 (2x)		
<b>VOLVO</b>							
S 80		4900-12 (2x)			4900-12 (2x)		



# Inside Spring Vice Set



• Optimally suited to the limited spaces when installing and removing the **coil spring at the rear axle** of the following vehicles:

- BMW** – 1 Series E87 (since 2004):  
116i, 118i, 118d, 120i, 120d, 130i  
– 3 Series E90 (since 2004):  
320i; 320d; 325i; 330i lim.  
– 3 Series E91 (since 2005):  
320; 325; 330 Touring

- Pendulum 6-point head provides a uniform distribution of power with the integrated twist protection
- Internal guidance of the tensioning jaws prevents the spring from sliding out
- Both-sided spindle operation possible

**Made in Germany**



**HAZET** No. EAN-No. 4000896+

**Set of 6 pieces** consisting of:

- Inside Spring Vice 4902-1
- Tensioning Jaw 4902-10
- Tensioning Jaw 4902-11
- Tubular Box Wrench s 10 4902-210
- Tubular Box Wrench s 24 4902-224
- Reversible Ratchet 4910-1

4902/6	121694
Inside Spring Vice 4902-1	122639
Tensioning Jaw 4902-10	122646
4902-11	122653
Tubular Box Wrench, size 10 mm 4902-210	122677
Tubular Box Wrench, size 24 mm 4902-224	122660
Reversible Ratchet 4910-1	062133

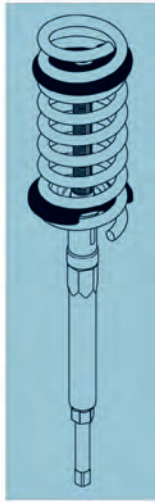

Chassis

## Shock Absorber Tool Assortment



344 x 188 x 56 mm



## Shock Absorber Tool Assortment



For repair work at the spring strut e.g. shock absorber, spring strut bearing, coil spring

- For retaining the piston rod when removing and installing the spring strut
- **Caution:** Follow vehicle manufacturer's specifications concerning torque values
- Application e.g. with torque wrench, e.g. HAZET 6291-1 CT in conjunction with Box-End Insert Tool 6630 d-21. Application of an impact wrench may damage the thrust bearing and the piston rod
- **Set of 13 pieces in plastic case**

**Made in Germany**

Contents:

- 4910-1  
4910-6 7 8  
4910-16 17 18 19 21 22 24  
4910-58 68

<b>HAZET</b> No.	EAN-No. 4000896+
4910/13	061495

## Reversible Ratchet



For repair work at the spring strut e.g. shock absorber, spring strut bearing, coil spring

- For retaining the piston rod when removing and installing the spring strut
- **Caution:** Follow vehicle manufacturer's specifications concerning torque values

**Made in Germany**

<b>HAZET</b> No.	EAN-No. 4000896+
Reversible Ratchet 4910-1	062133





## Specialty Tools – Chassis – Spring Vice / Shock Absorber

### Retainer for Piston Rod



For repair work at the spring strut e.g. shock absorber, spring strut bearing, coil spring

- For retaining the piston rod when removing and installing the spring strut
- **Caution:** Follow vehicle manufacturer's specifications concerning torque values

**Made in Germany**

HAZET No.	l mm	mm	EAN-No. 4000896+
4910-6	94.5	6	062089
4910-7	94.5	7	062096

- **Short style**
- For the operation of the piston rod nut when retaining the piston rod together with HAZET4910 K-21
- For repair work at the spring strut (shock absorber) on **VW** Sharan and **SEAT** Alhambra years 2000-2009, **FORD** Galaxy years 2000-2006
- Tool is especially suited to areas with restricted access in conjunction with HAZET 4910/13

4910 K-7	76	7	159871
4910-8	94.5	8	062102



For repair work at the spring strut e.g. shock absorber, spring strut bearing, coil spring

- For retaining the piston rod when removing and installing the spring strut
- **Caution:** Follow vehicle manufacturer's specifications concerning torque values

**Made in Germany**

HAZET No.	l mm	mm	EAN-No. 4000896+
4910-58	94.5	5 x 8	062119
4910-68	94.5	6 x 8	062126

For **PORSCHE** Cayenne S, **VW**-Touareg, Touran, Sharan

4910-71	94.5	7.1 x 9.6	091195
---------	------	-----------	--------

For **SMART** Forfour and **MITSUBISHI** Colt

4910-98	122.5	9.6 x 8.1	159949
---------	-------	-----------	--------

### 6-Point Socket



For repair work at the spring strut e.g. shock absorber, spring strut bearing, coil spring

- For retaining the piston rod when removing and installing the spring strut
- **Caution:** Follow vehicle manufacturer's specifications concerning torque values
- drive  $\leq 21$  mm

**Made in Germany**

HAZET No.	l mm	mm	EAN-No. 4000896+
4910-16	82	16	062010
4910-17	82	17	062027
4910-18	82	18	062034
4910-19	82	19	062041
4910-21	82	21	062058

- **Short style**
- For the operation of the piston rod nut when retaining the piston rod together with HAZET4910 K-7
- For repair work at the spring strut (shock absorber) on **VW** Sharan and **SEAT** Alhambra years 2000-2009, **FORD** Galaxy years 2000-2006
- Tool is especially suited to areas with restricted access

4910 K-21	51	21	159895
4910-22	82	22	062065
4910-24	82	24	062072

### Retainer for Piston Rod



For repair work at the spring strut e.g. shock absorber, spring strut bearing, coil spring

- For retaining the piston rod when removing and installing the spring strut
- **Caution:** Follow vehicle manufacturer's specifications concerning torque values

### Retainer for Piston Rod

**Made in Germany**

HAZET No.	l mm	mm	EAN-No. 4000896+
For <b>OPEL</b> Astra H, <b>MERCEDES-BENZ</b> C-Class (204), E-Class (212), E-Class Coupé (207)			
4910-T 50	122.5	T 50	120598

### Shock Absorber Releasing Tool



- For the operation of the upper fastening bolt at the front shock absorber, especially for **MERCEDES-BENZ**, type 639 Viano/Vito (V-Class)
- The releasing tool ensures the appropriate operation of this bolt according to the prescribed torque (follow vehicle manufacturer's instructions)
- Outside hexagon drive  $\leq 18$  mm
- Output  $\leq 21$  mm for the operation of the union nut ( $l = 227$  mm)
- Counterholder with square drive  $10$  mm =  $3/8$ "
- 7 mm screwdriver socket for the operation of the piston rod ( $l = 280$  mm)

**Made in Germany**

HAZET No.	EAN-No. 4000896+
2722-1	131730

### Shock Absorber Crown Wrench



- For the operation of shock absorber screw connections on **VW** and **AUDI** vehicles
- drive 22 mm,  $b =$  width of pins
- Surface: chrome-plated

**Made in Germany**

HAZET No.	mm	b mm	mm	EAN-No. 4000896+
For front axle: <b>VW</b> Polo, model year 1982				
2593-3	22	3.5	12.5	017249
For front axle: <b>VW</b> Golf 2, 3, Jetta, Vento, Passat, <b>AUDI</b> 80				
2593-4	22	5	14.5	017263

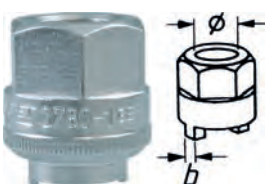

- For the operation of shock absorber screw connections on **MERCEDES-BENZ** type 203 (C-Class since 2000)
- drive 22 mm,  $b =$  width of pins
- Surface: chrome-plated

**Made in Germany**

HAZET No.	mm	b mm	EAN-No. 4000896+
2780-1	22	2.6	082858

**Wheel Bearing / Wheel Hub**

**Ball Joint Puller**



- For removing **ball joint pivots** of steering tie rods, stabilizers, etc.

$a$  = Span of the jaw

- Surface: galvanized

**Made in Germany**

HAZET No.	b mm	a mm	st mm	EAN-No. 4000896+
1779-18	40	18	33	136001
1779-23	50	23	42	136018
1779-27	54	27	54	136025
1779-37	75	37	77	136032

E.g. for commercial vehicles **MAN, MERCEDES-BENZ**, etc.

1779-55	77	55	80	136407
---------	----	----	----	--------

**Universal Ball Joint Puller**



- For removing the **ball joint pivots** of steering arms, steering tie rods, stabilizers, etc. on the most common vehicles
- Great clamping range due to continuous vertical adjustment and turn-over of the lower part

**Made in Germany**

HAZET No.	a mm	sb mm	EAN-No. 4000896+
1779-1	23	65	135974

**Ball Joint Puller**

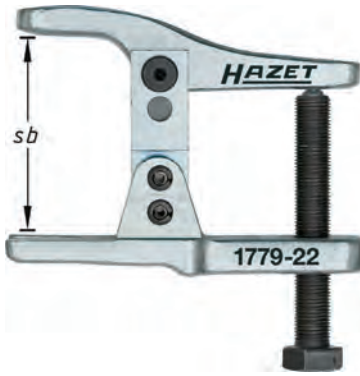

- For removing the **ball joint pivots** of steering arms, steering tie rods, steering knuckles, stabilizers, etc.
- Clamping range 50–80 mm
- Length of the jaw 35 mm

**Made in Germany**

HAZET No.	a mm	sb mm	EAN-No. 4000896+
1779-22	20	50–80	141654

**Universal Ball Joint Puller**



- For removing the **ball joint pivots** of steering arms, steering tie rods, stabilizers, etc. on the most common vehicles
- Sturdy execution and deep location groove enabling a safe and universal application e.g. for light commercial vehicles

**Made in Germany**

HAZET No.	a mm	sb mm	EAN-No. 4000896+
1779-3	32	85	135998

**Ball Joint Puller**



- For removing the **ball joint pivots** of steering arms, steering tie rods, stabilizers, etc. on heavy commercial vehicles
- Surface: galvanized, yellow passivated (free from Cr 6)
- For heavy commercial vehicles

**Made in Germany**

HAZET No.	a mm	sb mm	EAN-No. 4000896+
1790-3	40	85	145454





### Ball Joint Puller



- For removing **ball joint pivots** on vehicles with multi-link axle e.g. **AUDI A6** and **A8**, **VW Passat**, **Golf**
- Surface: galvanized, yellow passivated (free from Cr 6)

**Made in Germany**

HAZET No.	a mm	sb mm	EAN-No. 4000896+
1790-4	30	65	145447

### Ball Joint Puller



- For the safe removing of **ball joint pivots** and ball joints
- **Supported by hydraulic system**
- Surface: galvanized, yellow passivated (free from Cr 6)

**Made in Germany**

HAZET No.	a mm	sb mm	EAN-No. 4000896+
1790-5	30-34	70	145461
1790-6	36-40	85	145478

### Universal Ball Joint Puller



- For removing the **ball joint pivots** of steering tie rods, stabilizers, etc. on the most common vehicles
- Jaw opening 20 mm
- Clamping range (sb) in 2 stages  
stage 1: up to 30 mm  
stage 2: up to 50 mm
- On **FORD, BMW, VOLVO, TOYOTA, OPEL, VW, AUDI, RENAULT**

**Made in Germany**

HAZET No.	a mm	sb mm	EAN-No. 4000896+
1790-7	20	12-50	148073

### Removal and Assembly Fork



- Proven and economical system
- Easy application
- Wedge-shaped fork end allows fast removal of track rod and push rod ends, pitman arms and other parts of the steering
- Also suitable for removing shock absorbers and other separation work
- Application possible in confined spaces
- Sturdy forged design

**Made in Germany**

HAZET No.	l <sub>1</sub> mm	l <sub>2</sub> mm	b mm	EAN-No. 4000896+
1780-18	80	340	18	133345
1780-23	80	340	23	133352
1780-29	90	350	29	133376



### Universal Wheel Hub Puller



- Sliding and interchangeable pulling hooks
- With 5 hooks
- Optional accessories: hydraulic spindle 1786 H-02
- Surface: galvanized

**Made in Germany**

HAZET No.	Max. to.	sb mm	Spindel	EAN-No. 4000896+
1781-5	10	115-225	G 3/4" x 200	136049

### Clamping Screw Ejector, Four-Link Front Axle



- Enormous time saving due to possible usage of Chisel Hammer Set, e.g. HAZET 9035/6 (not included in delivery)
- Components do not have to be heated up, prevents damage of aluminium axle due to improper handling

**AUDI** A4 model years 1995-2005, A6 model years 1998-2002  
**VW** Passat

**Made in Germany**

Contents:  
2594-1 2 4

HAZET No.	EAN-No. 4000896+
3 pieces	
2594-1/4	175284
Hexagon insert	
2594-1	174874
Extractor	
2594-2	174881
Guide sleeve	
2594-4	174980

### Ball Pin Extractor



For removing the ball pins on swivel bearings

- For **FORD** Mondeo since 2007, S-Max, Galaxy since 2006, **MAZDA** 6, **JAGUAR** S-Type since 2007

**Made in Germany**

HAZET No.	EAN-No. 4000896+
Swivel bearing left side	
3490-1 L	166947
Swivel bearing right side	
3490-1 R	166930

### Wheel Bearing Housing Tool



- Suitable for the spring strut and ball joint mounting (separating the spring strut from the wheel bearing housing)
- drive 12.5 = 1/2"

**Made in Germany**

HAZET No.	EAN-No. 4000896+
Application on e.g. <b>VW</b> Fox since 2005, Polo since 2002, New Beetle, Golf from 1998 to 2004, Tiguan since 2008, Eos since 2006, Passat since 2006, Touran since 2003, Caddy since 2004, T5 since 2004	
<b>AUDI</b> A2 since 2001, A3 since 2004, A4 years 2001 to 2008, A5 since 2008, A6 since 2008, TT since 2007	
<b>SEAT, SKODA</b>	
Ø 5.5 x 8 mm	
4912-1	156368
Application on e.g. <b>RENAULT, PEUGEOT, CITROËN</b>	
Ø 5 x 7 mm	
4912-2	155804

### Tool Set for Camber Adjustment



Suitable for **VW** Golf, Jetta, **SEAT** Toledo, etc.

- Enables camber adjustment by one person only
- Tool significantly reduces the time required for the operation
- Sturdy 6-point spindle with s 22 mm for easy application
- Span: 135 up to 175 mm

HAZET No.	EAN-No. 4000896+
4912-3/2	166596





# Wheel Bearing Extractor

## Modular System in Assortment Case

✓ Made in Germany



Including operating instructions with 3-dimensional illustrations



Soft foam insert, empty

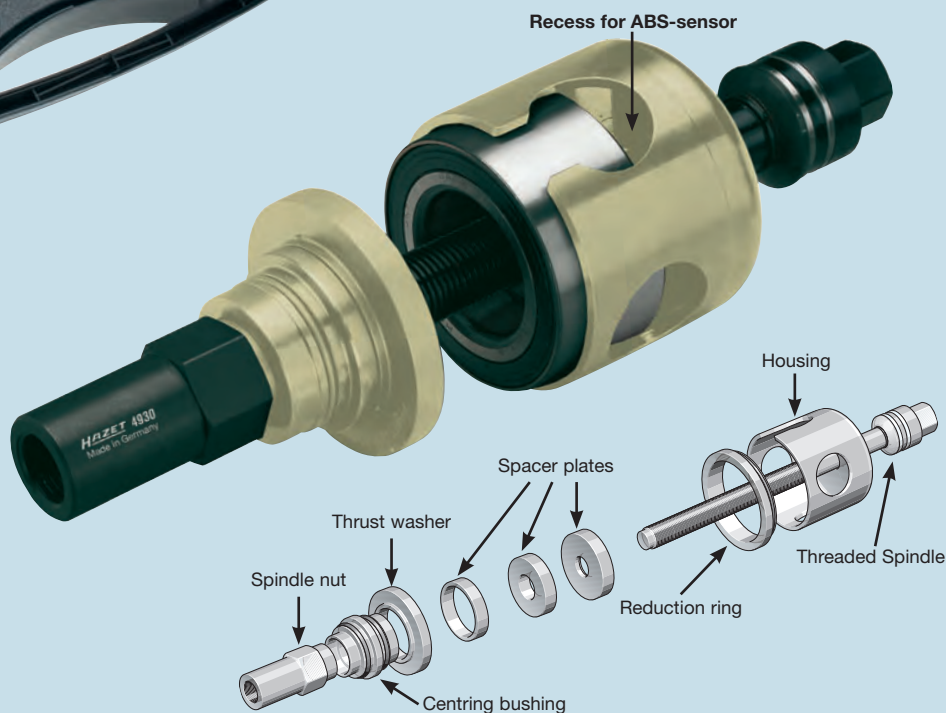

O-ring-clamping developed by HAZET retains the thrust washer on the centering bushing when installing and removing the wheel bearing.



Higher axial forces in spite of lower application of force (due to high capacity threaded spindle with special trapezoidal fine thread in conjunction with the axial cylinder roller bearing)



Optimal centering when inserting the wheel hub into the new wheel bearing

- For installing and removing wheel bearings as well as for installing wheel hubs
- Change of **built-in wheel bearings**
- Removing the strut unit as well as (front) camber adjustment are not necessary:
  - time-saving (approx. 30 min)
  - money-saving repair for the workshop customer
- Vehicles with **Anti-Lock Braking System (ABS)**
  - Due to the recess at the housing removal of the ABS sensor is not necessary
  - No risk of damaging the ABS sensor
  - Money and time-saving
- Centering aid due to calotte (spherical recess) at the housing

## Wheel Bearing Extractor

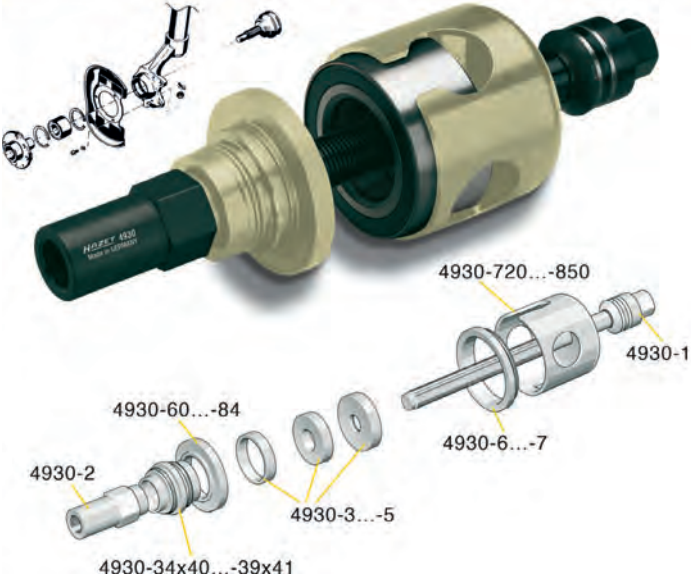

- For the **change of built-in wheel bearings**  
– removing of strut unit as well as camber adjustment are not necessary –
- Made in Germany**

HAZET No.	EAN-No. 4000896+
<b>Threaded spindle TR20 x 2</b> incl. thrust bearing, 6-point drive s 22 max. capacity 12 tons	
4930-1	080755
<b>Spindle nut s 30</b>	
4930-2	080762
<b>Spacer plate</b>	
4930-3	081158
4930-4	081141
4930-5	082834
<b>Reduction ring</b> 4930-6 for VW Polo C and PEUGEOT 106 in conjunction with housing 4930-720	
4930-6	083633
In conjunction with housing 4930-850	
4930-7	083640
Inside Ø 45 mm in conjunction with 4930-8245	
4930-8	097890
<b>Centering plate</b> for installing new wheel bearing on AUDI A4, A6	
4930-9	121465
<b>Centering bushing</b>	
4930-34 x 40	081042
4930-35 x 40	081066
4930-35 x 42	081035
4930-37 x 45	081073
4930-39 x 41	081028
4930-43 x 45	097739
<b>Thrust washer outside Ø 60 mm</b>	
4930-60	081011
<b>Thrust washer outside Ø 62 mm</b>	
4930-62	080854
<b>Thrust washer outside Ø 64 mm</b>	
4930-64	080939

## Wheel Bearing Extractor

HAZET No.	EAN-No. 4000896+
<b>Thrust washer outside Ø 66 mm</b>	
4930-66	080946
<b>Thrust washer outside Ø 68 mm</b>	
4930-68	080953
<b>Thrust washer outside Ø 72 mm</b>	
4930-72	080960
<b>Thrust washer outside Ø 74 mm</b>	
4930-74	080977
<b>Thrust washer outside Ø 80 mm</b>	
4930-80	081004
<b>Thrust washer outside Ø 82 mm</b>	
4930-82	080991
In conjunction with 4930-8	
4930-8245	097746
Outside Ø 84 mm	
4930-84	081448
<b>Housing, 72 mm Ø</b>	
4930-720	081080
<b>Housing, 82 mm Ø</b>	
4930-820	081097
<b>Housing, 85 mm Ø</b>	
4930-850	082179

## Wheel Bearing Extractor Set



- For **installing and removing wheel bearings** as well as for **installing wheel hubs**
  - Change of **built-in wheel bearings**
  - Removing the strut unit as well as (front) camber adjustment are not necessary
  - Vehicles with **Anti-Lock Braking System (ABS)**  
– due to the recess at the housing removal of the ABS sensor is not necessary  
– no risk of damaging the ABS sensor
  - Centering aid due to calotte (spherical recess) at the housing
  - High-quality threaded spindle with high capacity
  - In tool case (expandable)
  - Detailed operating instructions
- Made in Germany**

HAZET No.	EAN-No. 4000896+
<b>16 pieces for VW/AUDI, OPEL, FORD</b>	
Contents:	
4930-1 2 3 4 5	
4930-34 x 40 35 x 40 39 x 41	
4930-62 64 66 68 72 74	
4930-720 820	
4930-1/16	121328





## Wheel Bearing Extractor Set



- Wheel Bearing Extractor Set for hydraulic and mechanical operation
- Hydraulic operation together with the HAZET Hollow Piston Cylinder 4932-17 and the Hydraulic Spindle 4932-TR20

### 22 pieces, contents:

- Threaded spindle 4930-1 TR20 x 2 incl. thrust bearing, 6-point drive s 22, capacity max. 12 tons
- Spindle nut s 30 4930-2
- Spacer plates 4930-3 4 5
- Reduction ring 4930-4
- Housing 4930-721 821 851
- Centering bushing 4930-34 x 40 35 x 40 39 x 41 35 x 42 37 x 45
- Thrust washer 4930-62 64 66 68 72 74 82 84

**Made in Germany**

HAZET No.	EAN-No. 4000896+
4930-1/22	164776

## Hollow Piston Cylinder

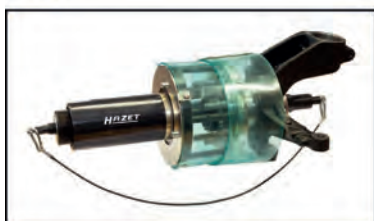

## Hollow Piston Cylinder

### Compact hydraulic cylinder with a capacity of 17 tons

- Working pressure: max. 700 bar
- With spring reset
- For threaded spindle 4932-TR20 and nut 4930-2
- Traction side: M27 x 2, alternatively M42 x 2, using the optional adapter
- Pressure side: 2-1/4" – 14 UNS inside thread: TR20, alternatively M20, using the optional adapter
- Stroke: 45 mm
- Outside diameter: 80 mm
- Cylinder height – retracted: 206 mm/extended: 251 mm
- With coupling and protective cover
- 5,5 kg

**Made in Germany**

HAZET No.	EAN-No. 4000896+
4932-17	159741
Threaded spindle with steel cable TR 20 for Hollow Piston Cylinder 4932-17 and nut 4930-2	
4932-TR 20	159765
Hydraulic thrust washer for 4934-2572/12, -2562/6, -2566/6 using 4932-17	
4934-10	159932
Hydraulic thrust washer for 4934-2585/12 using 4932-17	
4934-8510	159628
Housing Ø 72 mm for article group 4930 using 4932-17 with 4932-TR 20 and 4930-2	
4930-721	159598
Housing Ø 82 mm for article group 4930 using 4932-17 with 4932-TR 20 and 4930-2	
4930-821	159604
Housing Ø 85 mm for article group 4930 using 4932-17 with 4932-TR 20 and 4930-2	
4930-851	159611
<b>Adapter for spindles with M20 thread</b>	
• Adapter increases compatibility of HAZET Hollow Piston Cylinder with further spindles and specialty tools	
• Also suitable for tools of other manufacturers	
4932-M 20	165681

## Support for Hollow Piston Cylinder 4932-17

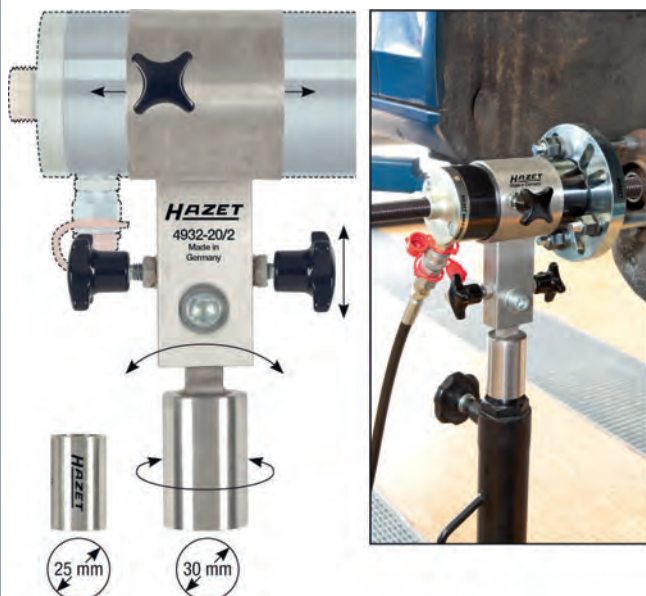

### Perfect handling of the Hollow Piston Cylinder and specialty tools on the vehicle

- Support for hollow piston cylinder 4932-17 (with an outside diameter of 80 mm), including the specialty tool in use, enables exact positioning of the cylinder to the vehicle
- Suitable for any standard elevator that support the exact positioning

**Made in Germany**

HAZET No.	EAN-No. 4000896+
4932-20/2	167999

**Support for Hollow Piston Cylinder 4932-17**

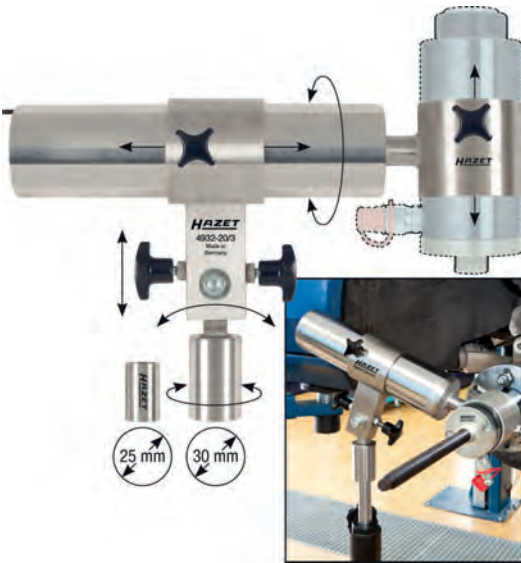

**Perfect handling of the Hollow Piston Cylinder and specialty tools on the vehicle**

- Support for hollow piston cylinder 4932-17 (with an outside diameter of 80 mm), including the specialty tool in use, enables exact positioning of the cylinder to the vehicle
- Suitable for any standard elevator that support the exact positioning

**Made in Germany**

HAZET No.	EAN-No. 4000896+
-----------	------------------

**Like 4932-20/2, but additionally equipped with optional extension**

- Application of the extension increases flexibility of movement to 6 axis and simplifies the exact positioning

4932-20/3	167951
-----------	--------

**Hydraulic Foot Pump, mechanical**



- 2 m hydraulic hose with coupling included
- Max. working pressure: 700 bar, overload protection
- Steel frame for highest stability
- Transport interlock
- Foot-controlled drain valve
- Big pedal
- 10 kg
- Piston stroke: 16 mm
- Capacity of the tank: 1000 ml
- Dimensions: 750 x 230 x 170 mm

**Made in Germany**

HAZET No.	EAN-No. 4000896+
4932-100	159550

**High-Pressure Manometer**

Suitable for usage with the HAZET Hydraulic Foot Pump 4932-100

- 63 up to 1000 bar
- For pressure control when using a spindle with limited capacity
- With CU seal and cutting ring for accurate manometer adjustment

4932-101	168057
----------	--------

**Air-Hydraulic Pump**



- 2 m hydraulic hose with coupling and 3 m pneumatic hose included
- Max. working pressure: 700 bar
- Air inlet thread: 6.3 mm = 1/4"
- Hydraulic connection: 10 mm = 3/8" – 18 NPTF
- Big pedal: pump, hold, release
- 5,3 kg
- Capacity Rating: 0,7 l/min
- Quantity of oil: 1400 ml/Utilisable quantity: 1100 ml
- Dimensions: 295,5 x 145 x 172 mm

**Made in Germany**

HAZET No.	EAN-No. 4000896+
4932-110	159567

**Inner Bearing Ring Extraction Tool Set, 8 pieces**



**For extracting the inner bearing rings that remain on the wheel hub when removing the wheel bearing**

- Increased torque allows firm chuck tightening. Preventing from slipping-off the bearing ring
- Also suitable for types with ABS-housing
- Esp. suitable for inner bearing rings that rest against the wheel hub
- Suitable for **AUDI, BMW, FORD, MERCEDES-BENZ, PEUGEOT, RENAULT, TOYOTA, VW**
- Spindle with motion screw thread allows high removal forces
- Due to the torque arm, assembly may be placed into a machinist's vice
- 4 chucks (40 to 45 mm/45 to 50 mm/50 to 55 mm/55 to 61 mm) covering all diameters from 40 to 61 mm
- Clearly arranged in high-quality plastic case with soft foam insert
- Incl. detailed illustrated operating instructions

**Made in Germany**

HAZET No.	EAN-No. 4000896+
4931-1/8	155538

Chassis





# HAZET – Compact Wheel Hub / Wheel Bearing Tool Sets

## Diversity with System!

For installing and removing the wheel hub / wheel bearings of built-in parts on vehicles of VOLKSWAGEN-Group (VW, AUDI, SEAT, SKODA)



- ✓ Provides *security* and *effectiveness*
- ✓ Suitable for all common wheel hub and wheel bearing dimensions
- ✓ Usable with spindle 4930-1 and spindle nut 4930-2
- ✓ Favourable introductory set for wheel bearings with a  $\varnothing$  of 72 mm
- ✓ Perfect supplementary sets for  $\varnothing$  of 62 mm and 66 mm
- ✓ Special set for units with a  $\varnothing$  of 85 mm completes the programme



## Basic Working Equipment:

e.g. from the sets 4930-1/16 to -29/13 or 4934-25/14

Spindle 4930-1

Spindle nut 4930-2



Suggestion on how to put a set together from professionals for professionals:

4934-2572/12 – Introductory Set	( $\varnothing$ 72 mm)
+ 4934-2562/6 – Supplementary Set	( $\varnothing$ 62 mm)
+ 4934-6604/3 – Thrust rings for removal	( $\varnothing$ 66 mm)
+ 4934-6605/3 – Thrust rings for installation	( $\varnothing$ 66 mm)
= Perfect equipment	



Single parts available – please contact your HAZET partner!

## Classification examples:

For more information see [www.hazet.de](http://www.hazet.de) in the internet:  
[www.hazet.de](http://www.hazet.de) → Online-Katalog → Produktanwendungen → Radlager-Zuordnung





Technical modifications of the vehicle manufacturers are subject to change without notice

 Type	 Year of bearing installation	Note	Position	 Bearing	HAZET Wheel Bearing Tool Set	NTN-SNR Reference
<b>AUDI</b>						
A1	5/2010		Front axle	72 mm	4934-2572/12 & 4930-1 & 4930-2	R157.32
A2 1.4 i/1.6 FSI/1.4 Tdi (AU24)	6/2000	With Anti-Lock Braking System (ABS)	Front axle	72 mm	4934-2572/12 & 4930-1 & 4930-2	R157.32
A2 1.2 TDi (AU24)	3/2001		Front axle	62 mm	4934-2562/6 & 4930-1 & 4930-2 & 4934-2572/12	R154.52
<b>FORD</b>						
C-Max (CB3)	2/2007		Front axle	78 mm	4934-3478/11 & 4930-1 & 4930-2	R152.62
Focus 2	9/2004 – 11/2007		Front axle	78 mm	4934-3478/11 & 4930-1 & 4930-2	R152.62
Focus 2 FL 1.4 i/1.6 i/1.6 TDCi/1.6 Ti-VCT/1.8i/1.8 TDCi/2.0 i/2.0 TDCi/2.5 i	12/2007		Front axle	78 mm	4934-3478/11 & 4930-1 & 4930-2	R152.62
Focus C-MAX	6/2003 – 2/2007		Front axle	78 mm	4934-3478/11 & 4930-1 & 4930-2	R152.62
Focus Coupé Cabriolet 1.6 i/2.0 i/2.0 TCDCi	7/2006		Front axle	78 mm	4934-3478/11 & 4930-1 & 4930-2	R152.62
<b>MAZDA</b>						
Mazda 3 (BK) 1.4 i/1.6 DE/1.6 i/2.0 i	6/2003 – 1/2005		Front axle	78 mm	4934-3478/11 & 4930-1 & 4930-2	R170.41
<b>SEAT</b>						
Cordoba 4	9/2002 – 6/2005		Front axle	72 mm	4934-2572/12 & 4930-1 & 4930-2	R157.32
Cordoba 4 1.2 i/1.4 i/1.4 TDi/1.6 i/1.9 SDi/1.9 TDi	6/2005		Front axle	66 mm	4934-2566/6 & 4930-1 & 4930-2 & 4934-2572/12	R157.49
Cordoba 4 1.9 TDi 131PS (Engine ALZ,BLT)	6/2005		Front axle	72 mm	4934-2572/12 & 4930-1 & 4930-2	R157.32
Cordoba 4 2.0 i	6/2005		Front axle	72 mm	4934-2572/12 & 4930-1 & 4930-2	R157.32
Ibiza 3	9/2001 – 6/2005	Serial identification no. - 6L-6-000001	Front axle	72 mm	4934-2572/12 & 4930-1 & 4930-2	R157.32
Ibiza 3 1.2 12V/1.4 16V/1.4 TDi/1.6/1.9SDi	6/2005 – 11/2009		Front axle	66 mm	4934-2566/6 & 4930-1 & 4930-2 & 4934-2572/12	R157.49
Ibiza 3 1.9 TDi 100PS (Engine ATD)	5/2004 – 11/2009		Front axle	66 mm	4934-2566/6 & 4930-1 & 4930-2 & 4934-2572/12	R157.49
Ibiza 3 1.9 TDi 130PS (Engine ASZ)	6/2005 – 11/2009		Front axle	72 mm	4934-2572/12 & 4930-1 & 4930-2	R157.32
Ibiza 3 1.9 TDi Cupra 160PS (Engine BPX)	6/2005 – 11/2009		Front axle	72 mm	4934-2572/12 & 4930-1 & 4930-2	R157.32
Ibiza 3 2.0i/1.8 20V	6/2005 – 11/2009		Front axle	72 mm	4934-2572/12 & 4930-1 & 4930-2	R157.32
Ibiza 4	3/2008		Front axle	72 mm	4934-2572/12 & 4930-1 & 4930-2	R157.32
<b>SKODA</b>						
Fabia (6Y)	8/1999 – 7/2004	With power steering	Front axle	72 mm	4934-2572/12 & 4930-1 & 4930-2	R157.32
Fabia (6Y) [CZ]	8/1999 – 7/2002	Without power steering / speed nut serial identification no. - 6Y-2-366084	Front axle	66 mm	4934-2566/6 & 4930-1 & 4930-2 & 4934-2572/12	R178.05
Fabia (6Y) [CZ]	7/2002 – 7/2004	Without power steering / double hexagon head nut / serial identification no. 6Y-3-366085 -	Front axle	66 mm	4934-2566/6 & 4930-1 & 4930-2 & 4934-2572/12	R157.49
Fabia (6Y) [PL]	8/1999 – 9/2002	Without power steering / speed nut serial identification no. - 6Y-2X-028027	Front axle	66 mm	4934-2566/6 & 4930-1 & 4930-2 & 4934-2572/12	R178.05
Fabia (6Y) [PL]	9/2002 – 7/2004	Without power steering / double hexagon head nut / serial identification no. 6Y-2X-028028 -	Front axle	66 mm	4934-2566/6 & 4930-1 & 4930-2 & 4934-2572/12	R157.49





## Specialty Tools – Chassis – Wheel Bearing / Wheel Hub

 Type	 Year of bearing installation	Note	Position	 Bearing	HAZET Wheel Bearing Tool Set	NTN-SNR Reference
<b>SKODA</b>						
Fabia Facelift (6Y)	8/2004 – 12/2007	With power steering / with Anti-Lock Braking System (ABS) / wheel rims 14 inch	Front axle	72 mm	4934-2572/12 & 4930-1 & 4930-2	R157.32
Fabia Facelift (6Y)	8/2004 – 12/2007	Without power steering	Front axle	66 mm	4934-2566/6 & 4930-1 & 4930-2 & 4934-2572/12	R157.49
Fabia 2 (5J)	12/2006	With Anti-Lock Braking System (ABS)	Front axle	72 mm	4934-2572/12 & 4930-1 & 4930-2	R157.32
Fabia 2 Facelift	3/2010	Brake discs 256 mm	Front axle	72 mm	4934-2572/12 & 4930-1 & 4930-2	R157.32
Roomster	3/2006 – 3/2010	With Anti-Lock Braking System (ABS)	Front axle	72 mm	4934-2572/12 & 4930-1 & 4930-2	R157.32
Roomster Facelift 1.2 i/1.4 i/1.4 TDi/1.6 i/1.9 TDi	3/2010	Brake discs 256 mm	Front axle	72 mm	4934-2572/12 & 4930-1 & 4930-2	R157.32
<b>VOLKSWAGEN</b>						
Fox 1.2 i	11/2004	With Anti-Lock Braking System (ABS) / brake discs 239 mm	Front axle	66 mm	4934-2566/6 & 4930-1 & 4930-2 & 4934-2572/12	R157.49
Fox 1.2 i	11/2004	Brake discs 256 mm	Front axle	72 mm	4934-2572/12 & 4930-1 & 4930-2	R157.32
Fox 1.4 i	11/2004	With Anti-Lock Braking System (ABS)	Front axle	72 mm	4934-2572/12 & 4930-1 & 4930-2	R157.32
Fox 1.4 TDi	11/2004	With Anti-Lock Braking System (ABS)	Front axle	72 mm	4934-2572/12 & 4930-1 & 4930-2	R157.32
Lupo 1.2 TDi	5/1999 – 7/2005		Front axle	62 mm	4934-2562/6 & 4930-1 & 4930-2 & 4934-2572/12	R154.52
Polo 7 (9N) 1.2 i / 1.4 / 1.4FSi / 1.6	1/2002 – 10/2003	Without power steering	Front axle	66 mm	4934-2566/6 & 4930-1 & 4930-2 & 4934-2572/12	R157.49
Polo 7 (9N) 1.2 i / 1.4 / 1.4FSi / 1.6	11/2003 – 7/2004	With power steering	Front axle	72 mm	4934-2572/12 & 4930-1 & 4930-2	R157.32
Polo 7 (9N) 1.4 Tdi/1.9 Sdi/1.9 Tdi	11/2001 – 5/2005		Front axle	72 mm	4934-2572/12 & 4930-1 & 4930-2	R157.32
Polo 8 (9N) 1.2 i/1.4 i/1.4 FSi/1.4 16V/ 1.6	4/2005 – 7/2007	Without power steering	Front axle	66 mm	4934-2566/6 & 4930-1 & 4930-2 & 4934-2572/12	R157.49
Polo 8 (9N) 1.2 i/1.4 i/1.4 FSi/1.4 16V/ 1.6	4/2005 – 8/2007	With power steering	Front axle	72 mm	4934-2572/12 & 4930-1 & 4930-2	R157.32
Polo 8 (9N) 1.4 TDi/1.9 SDi/1.9 TDi	4/2005 – 8/2007		Front axle	72 mm	4934-2572/12 & 4930-1 & 4930-2	R157.32
Touareg 1 2.5 TDi	1/2003 – 10/2003		Front axle	85 mm	4934-2585/12 & 4930-1 & 4930-2	R154.58
Touareg 1 2.5 TDi	10/2003 – 11/2006		Front axle	85 mm	4934-2585/12 & 4930-1 & 4930-2	R154.62
Touareg 1	11/2002 – 11/2006	Wheel rims 16 inch / serial identification no. - 4,035,000	Rear axle	85 mm	4934-2585/12 & 4930-1 & 4930-2	R154.58
Touareg 1	11/2002 – 11/2006	Wheel rims 16 inch / serial identification no. 4,035,001 -	Rear axle	85 mm	4934-2585/12 & 4930-1 & 4930-2	R154.62
Touareg 1 FL	12/2006 – 5/2010	Wheel rims 16 inch	Rear axle	85 mm	4934-2585/12 & 4930-1 & 4930-2	R154.62
Transporter 7E/7F (T5)	9/2009		Front axle	85 mm	4934-2585/12 & 4930-1 & 4930-2	R154.62
Transporter 7E/7F (T5)	9/2009		Rear axle	85 mm	4934-8507 & 4930-1 & 4930-2 & 4934-2585/12	R154.58
Transporter 7J/7H (T5)	4/2003 – 8/2003		Front axle	85 mm	4934-2585/12 & 4930-1 & 4930-2	R154.58
Transporter 7J/7H (T5)	8/2003 – 11/2009		Front axle	85 mm	4934-2585/12 & 4930-1 & 4930-2	R154.62
Transporter 7J/7H (T5)	8/2003 – 11/2009		Rear axle	85 mm	4934-8507 & 4930-1 & 4930-2 & 4934-2585/12	R154.58
<b>VOLVO</b>						
C30	10/2006		Front axle	78 mm	4934-3478/11 & 4930-1 & 4930-2	R165.37
C70 CC	1/2006		Front axle	78 mm	4934-3478/11 & 4930-1 & 4930-2	R165.37
S40 2	3/2004		Front axle	78 mm	4934-3478/11 & 4930-1 & 4930-2	R165.37
V50	3/2004		Front axle	78 mm	4934-3478/11 & 4930-1 & 4930-2	R165.37

**Compact Wheel Hub / Wheel Bearing Tool Set**



For installing and removing the wheel hub / wheel bearings of built-in parts  
HAZET recommends NTN-SNR-Wheel Bearings  
**Made in Germany**

HAZET No.	EAN-No. 4000896+
-----------	------------------

**Introductory Set (72 mm Ø)**  
Basic requirements: threaded spindle 4930-1, spindle nut 4930-2  
**Application:**  
Vehicles with a Ø 72 mm wheel bearing:  
**AUDI** A1 since 2011, A2 since 2000, **SKODA** Fabia since 2000, **VW** Polo since 2002, Fox since 2005, **SEAT** Ibiza since 2002

- Including operating instructions with 3-dimensional illustrations
- **Set with 12 pieces in plastic case**
- Foam insert with empty compartments for additional tool storage
- Contents:  
pressure plate 4934-1, thrust washer 4934-7802, forcing bolt 4934-3 (5x), back-up ring 4934-4, back-up ring 4934-5, thrust washer 4934-6, 2 cylinder screws

4934-2572/12	150410
<b>Components (removal)</b> back-up ring 4934-4, 2 cylinder screws 4934-4/3	149629
<b>Components (installation)</b> back-up ring 4934-5, 2 cylinder screws 4934-5/3	150335



For installing and removing the wheel hub / wheel bearings of built-in parts  
HAZET recommends NTN-SNR-Wheel Bearings  
**Made in Germany**

HAZET No.	EAN-No. 4000896+
-----------	------------------

**Supplementary Set (62 mm Ø)**  
**Application:**  
Vehicles with a Ø 62 mm wheel bearing:  
**VW** Lupo, **AUDI** A2 1.2 l  
(Basic requirements: threaded spindle 4930-1, spindle nut 4930-2, as well as set 4934-2572/12)

- **Set with 6 pieces, contents:**  
pressure plate 4934-6202, pressure plate 4934-6206, back-up ring 4934-6204, back-up ring 4934-6205, 2 cylinder screws

4934-2562/6	150403
-------------	--------

**Compact Wheel Hub / Wheel Bearing Tool Set**

HAZET No.	EAN-No. 4000896+
-----------	------------------

**Components (removal)**  
back-up ring 4934-6204, 2 cylinder screws  
4934-6204/3

150366
--------

**Components (installation)**  
back-up ring 4934-6205, 2 cylinder screws  
4934-6205/3

150373
--------

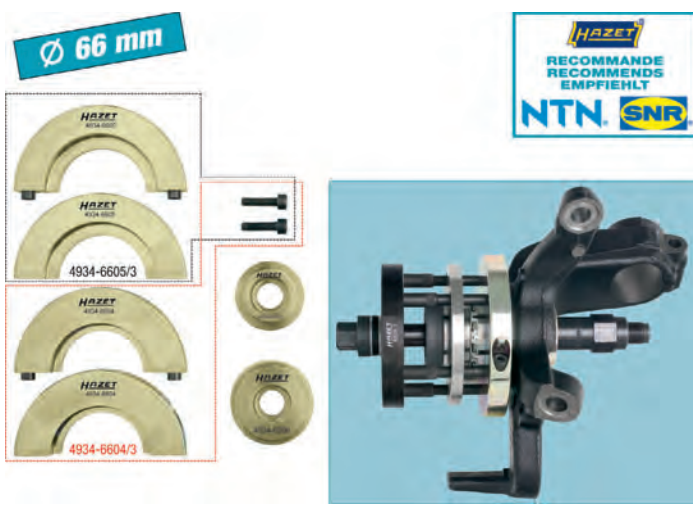

For installing and removing the wheel hub / wheel bearings of built-in parts  
HAZET recommends NTN-SNR-Wheel Bearings  
**Made in Germany**

HAZET No.	EAN-No. 4000896+
-----------	------------------

**Supplementary Set (66 mm Ø)**  
**Application:**  
Vehicles with a Ø 66 mm wheel bearing:  
**VW** Polo, **SKODA** Fabia  
Basic requirements: threaded spindle 4930-1, spindle nut 4930-2, as well as set 4934-2572/12

- **Set with 6 pieces, contents:**  
pressure plate 4934-6202, pressure plate 4934-6206, back-up ring 4934-6604, back-up ring 4934-6605, 2 cylinder screws

4934-2566/6	150427
<b>Components (removal)</b> back-up ring 4934-6604, 2 cylinder screws 4934-6604/3	150359
<b>Components (installation)</b> back-up ring 4934-6605, 2 cylinder screws 4934-6605/3	150342







## Compact Wheel Hub/Wheel Bearing Tool Set

For installing and removing the wheel hub/wheel bearings of built-in parts  
HAZET recommends NTN-SNR-Wheel Bearings

**Made in Germany**

HAZET No. EAN-No.  
4000896+

**Special Set (85 mm Ø)**

**Application:**

Vehicles with a Ø 85 mm wheel bearing:

**VW T5** (front and rear axle – rear axle only in conjunction with 4934-8507) and Touareg with 16 inch chassis

Basic requirements: threaded spindle 4930-1, spindle nut 4930-2

• Including operating instructions with 3-dimensional illustrations

• **Set with 12 pieces** in plastic case

• Foam insert with empty compartments for additional tool storage

• Contents:

pressure plate 4934-8501, thrust washer 4934-7802, thrust washer 4934-8506, forcing bolt 4934-8503 (5x) back-up ring 4934-8504, back-up ring 4934-8505, 2 cylinder screws

4934-2585/12 150434

**Components (removal)**

back-up ring 4934-8504, 2 cylinder screws

4934-8504/3 150397

**Components (installation)**

back-up ring 4934-8505, 2 cylinder screws

4934-8505/3 150380

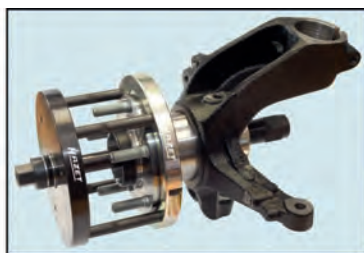

For installing and removing the wheel hub/wheel bearings with stud bolts of built-in parts

• Special Set Ø 78 mm bearing unit with stud bolts for:  
**FORD** Focus 2 since 2004, Focus C-Max model years 2003-2007 as well as C-Max since 2007

**VOLVO** C30 since 2006, C70 2 Cabriolet since 2006, S40 since 2004, V50 since 2004

**MAZDA** 3 (BK) 1.4i 1.6i, 2.0i 1.6DI Turbo since 2003

• Mechanical operation with HAZET Threaded Spindle 4930-1 as well as Spindle Nut 4930-2

• Hydraulic operation with HAZET Hollow Piston Cylinder 4932-17, Threaded Spindle 4932-TR 20 as well as e.g. Hydraulic Foot Pump 4932-100 and Protective Cover 4934-7

Contents:

4934-7801 pressure plate

4934-7802 thrust washer

4934-7804 back-up ring

4934-7805 back-up ring

4934-7806 thrust washer

4934-8503 4 forcing bolt

2 cylinder screws

**Made in Germany**

HAZET No. EAN-No.  
4000896+

4934-3478/11 166350

## Compact Wheel Hub/Wheel Bearing Tool Set

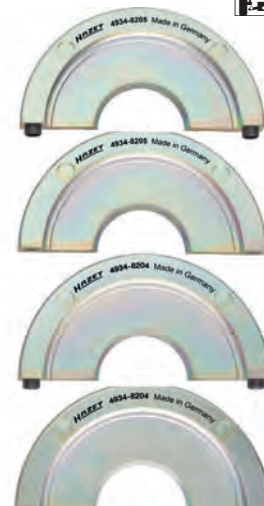
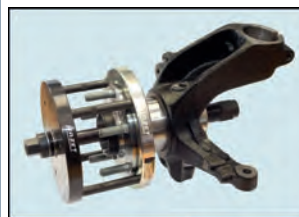

For installing and removing the wheel hub/wheel bearings with stud bolts of built-in parts

• Special Set Ø 82 mm bearing unit with stud bolts for:

**FORD** Mondeo 4, year 2007; Focus 2 2.5 RS as well as 2.5 RS 500 since 2007  
HAZET recommends NTN-SNR-Wheel Bearings

• Basic set 4934-3478/11

• Mechanical operation with HAZET Threaded Spindle 4930-1, Spindle Nut 4930-2, Pressure Plate 4934-7801 as well as 5 pieces Forcing Bolts 4934-8503 6 pieces, contents:

• Thrust washer 4934-8202 (removal)

• Back-up ring 4934-8204 (removal)

• Back-up ring 4934-8205 (installation)

• Thrust washer 4934-8206 (installation)

• 2 cylinder screws

**Made in Germany**

HAZET No. EAN-No.  
4000896+

4934-3482/6 174966

## Protective Cover



• Serves as crush protection during hydraulic operation of the HAZET Specialty Tools 4934

• Consists of a mounting ring and plastic cover, 3 fixing screws and one additional cover

**Made in Germany**

HAZET No. EAN-No.  
4000896+

4934-7 164783

## Adapter Ring VW T5



• To supplement the compact wheel hub/wheel bearing tool set 4934-2585/12

• Especially to be used together with pressure plate 4934-8506

• For installing the wheel hub/wheel bearings at the **VW rear axle T5**

**Made in Germany**

HAZET No. EAN-No.  
4000896+

4934-8507 154913

## Wheel Hub- / Cardan Shaft Extractor Set

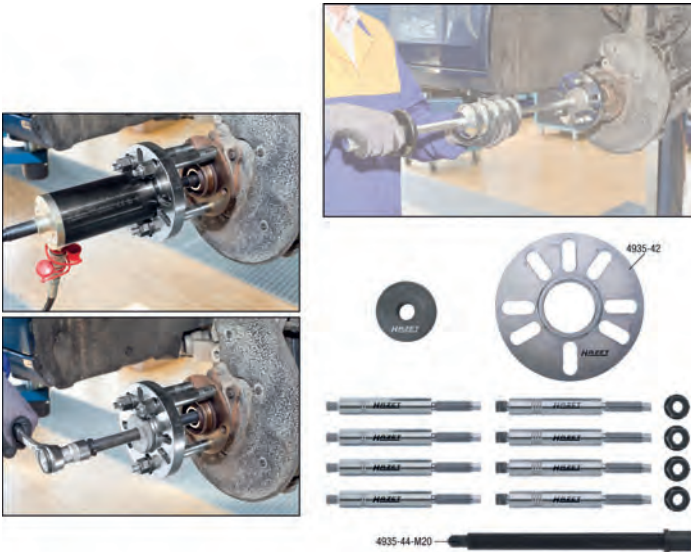

- For the removal of cardan shafts using the threaded spindle HAZET 4935-44-M 20
- When using the HAZET Hollow Piston Cylinder 4932-17 even tight and stuck cardan shafts will not cause any problems
- Suitable for:  
**ALFA ROMEO, AUDI, BMW, CITRÖEN, FIAT, LADA, LANCIA, MERCEDES-BENZ, OPEL, PEUGEOT, RENAULT, SAAB, SEAT, VW** etc.

Made in Germany

Contents:

- 4935-40-M 12
- 4935-41-M 14
- 4935-44-M 20
- 4935-45-M 14
- 4935-42 4935-43

HAZET No.	EAN-No. 4000896+
4935-2/15	164479
Tension Bolt M12 x 1,5	
4935-40-M12	166749
Tension Bolt M14 x 1,5	
4935-41-M14	166732
Bolt Circle Plate Ø 160 mm, for bolt circles with a Ø of 90 up to 130 mm	
4935-42	166657
Adapter 2 ¼"-14UNS	
4935-43	166664
Threaded Spindle 230 mm long	
4935-44-M 20	165629
Hexagon Collar Nut M14	
4935-45-M14	165612

## Impact Extractor



- For extracting 4-, 5- and 6-hole wheel hubs, full-floating axles, brake discs, brake drums etc. to be used with HAZET Cardan Shaft Extractor Set 4935-2/15 or the HAZET Adapter Plate 4935-42
- Striking weight 4.8 kg

HAZET No.	l mm	EAN-No. 4000896+
1969-16/2	690	164462

## Wheel Hub Grinder



### For optimal cleaning of wheel hubs and brake discs

- Prevents the falsification of the wheel bolt tightening torque originated by corrosion
- Open pored abrasive material and cup formed grinding pad reduce the formation of dust to a minimum
- 10 mm 3-point pin, e.g. for the use in (air) drills
- No formation of sparks
- Wear-resistant grinding wheels
- Hook and loop back for quick changing of grinding wheels

HAZET No.	Ø mm	EAN-No. 4000896+
-----------	------	------------------

For wheel hubs with stud bolts (grinding zone Ø 40 or 50 mm), e.g. **FORD, PORSCHE, VOLVO**, Japanese passenger cars

- Wear-resistant: approx. 50 vehicles per wheel
- Max. 1,500 rpm
- **Set with 14 pieces**

Contents: 2 grinding pads, 6 grinding wheels each Ø 40 and 50 mm

4960-45/14	-	132324
------------	---	--------

Optimized for use on new wheel hubs with increased inside diameter (75 mm Ø), e.g. on **BMW: X1, X3, X5, X6, 1-series, 3-series, 5-series, Touring, GT (Gran Turismo), 7-series**, etc.

- For wheel hubs up to a 160 mm Ø on passenger cars and vans
- Wear-resistant: approx. 100 vehicles per wheel
- Max. 1,500 rpm
- **Set with 4 pieces**

Contents: 1 grinding pad, 3 grinding wheels Ø 160 mm

4960-160/4	160	132287
------------	-----	--------

For wheel hubs on passenger cars and transporters up to a Ø of 200 mm, e.g. **BMW, FIAT Ducato, MERCEDES-BENZ Sprinter** etc.

- Wear-resistant: approx. 100 vehicles per wheel
- Max. 1,000 rpm
- **Set with 3 pieces**

Contents: 1 grinding pad, 2 grinding wheels Ø 200 mm

4960-200/3	200	143290
------------	-----	--------

5 Replacement grinding wheels, Ø 40 mm

4960-040/5	40	132294
------------	----	--------

5 Replacement grinding wheels, Ø 50 mm

4960-050/5	50	132300
------------	----	--------

3 Replacement grinding wheels, Ø 160 mm

4960-0160/3	160	132263
-------------	-----	--------

2 Replacement grinding wheels, Ø 200 mm

4960-0200/2	200	143306
-------------	-----	--------





### Wheel Hub Grinder for Commercial Vehicles



Special grinder for optimal cleaning of the bearing surface of a wheel rim (wheel hubs) on trucks and transporters with stud bolt

- Prevents the falsification of the wheel bolt tightening torque originated by corrosion
- Open pored abrasive material and cup formed grinding pad reduce the formation of dust to a minimum
- No formation of sparks
- Wear-resistant grinding wheels
- Hook and loop back for quick changing of grinding wheels
- Max. inner-Ø: 23 mm
- Grinding wheels-Ø: 56 mm
- **Set of 11 pieces**

**Contents:**

- 1 grinding pad with 1 grinding wheel
- 5 grinding wheels for moderate stains
- 5 grinding wheels for heavy stains

HAZET No.	EAN-No. 4000896+
4961-23/11	167630
For moderate stains 4961-023 M/5	167647
For heavy stains 4961-023 S/5	167654

### Silent Block

### Tool Set for Silent Blocks

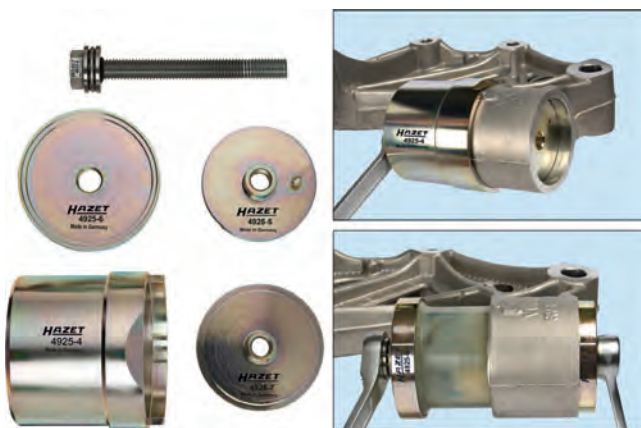

For VW, AUDI, SEAT, SKODA

- Extraction and insertion pressure plate, housing
- For extracting and inserting the silent blocks located in the console of the transverse control arm at the front axle
- Enables working on built-in components
- Tool set avoids wheel alignment

VW Polo 9N model years 2002–2009, Fox since 2005

AUDI A2 model years 2000–2005

SKODA Fabia model years 2000–2004

SEAT Ibiza, Altea, Cordoba model years 2003–2005

**5 pieces, contents:**

- 4925-4 Housing
- 4925-5 Extraction pressure plate
- 4925-6 Insertion pressure plate
- 4925-7 Insertion centring plate
- 4925-8 Thrust bearing screw

**Made in Germany**

HAZET No.	EAN-No. 4000896+
4925-2501/5	159406

### Tool Set for Silent Blocks

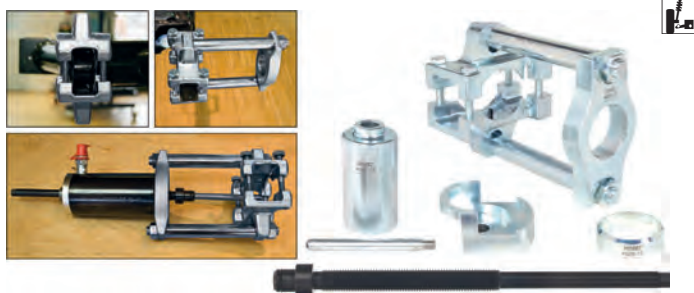

- Suitable for silent blocks with a Ø of 56 mm on VW Golf III rear axle
- May also be used with the Hollow Piston Cylinder HAZET 4932-17 for tight silent blocks

• **Set of 6 pieces**

**Made in Germany**

HAZET No.	EAN-No. 4000896+
4925-10/6	164509

### Supplementary Set, hydraulic, for installation 4925-2504/9



- Suitable for the hydraulic installation of **rubber-plastic bearings** or **rubber-metal bearings** at the rear axle VW Golf 4

- May be used with HAZET 4932-17 and 4925-27/3 for tight silent blocks

• **Set of 2 pieces**

4925-28, -30

**Made in Germany**

HAZET No.	EAN-No. 4000896+
4925-2504/2	168026

### Tool Set for Silent Blocks



Suitable for installation and removal of the rubber-plastic bearings or rubber-metal bearings at the rear axle

- Suitable for AUDI A3, VW Golf 4, Bora, New Beetle, SKODA Octavia since 1997, SEAT Leon, Toledo since 2001

- Mechanical actuation with spindle set 4929-1/3

- May also be used with the Hollow Piston Cylinder HAZET 4932-17 for tight silent blocks

• **9 pieces:**

**Made in Germany**

**Contents:**

- 4925-14 20 21 22 23 24 25 26
- 4930-821

HAZET No.	EAN-No. 4000896+
4925-2504/9	168019

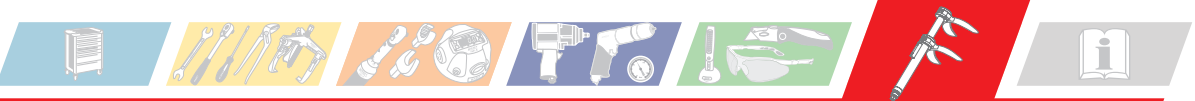

### Hydraulic Expansion Set



For the operation of the Tool Set for Silent Blocks 4925-2505/9 with the Hollow Piston Cylinder 4932-17

Contents:

- Adapter for Hollow Piston Cylinder HAZET 4932-17
- Spindle 4925-18 M14x1.5, max. capacity 9 to.
- Spindle nut

**Made in Germany**

HAZET No.	l mm	EAN-No. 4000896+
4925-2505/3	422	167937

### Tool Set for Silent Blocks



For VW T5 Transporter

- For extracting and inserting silent block bushings on VW T5 rear axle
- Mechanical drive with enclosed spindle
- **Set of 9 pieces:** centring plate with spring, 2 x thrust washer, adapter ring, washer, spindle with nuts 4925-14 TR 14 x 2, housing

**Made in Germany**

HAZET No.	l mm	EAN-No. 4000896+
4925-2505/9	259	167920



### Tool Set for Silent Blocks

Silent block replacement from the installed axle control arm/longitudinal control arm, wheel bearing housing and lower/inside transverse control arm as well as from the steering tie rod and the upper transverse control arm, when removed from the vehicle

- **Optional** spindle set 4929-1/3
- Mechanical actuation with spindle set 4929-1/3
- For installation and removal of silent blocks at the rear axle on:  
**VW:** Golf 5 Plus/Variant/4Motion model years 2005-2012, Jetta/ Syncro model years 2006-2012, Scirocco model years 2009-2012, Beetle model year 2012, Eos model years 2006-2012  
**SEAT:** Altea model years 2004-2012, Leon model years 2006-2012, Toledo model years 2005-2009  
**AUDI:** A3/S3 model years 2004-2012, TT/TTS Coupe/Roadster model years 2007-2012

**Made in Germany**

Contents:

- 4925-26 31 32 33 34 35 36 37
- 38 39 40 41 42 43 44
- 4930-721

HAZET No.	EAN-No. 4000896+
4925-2506/16	175246

### Spindle Set for hydraulic operation



For Silent Block Tool Set 4925-2504/9 and Supplementary Set 4925-2504/2

- Suitable for the hydraulic installation and removal of rubber-plastic bearings- and rubber-metal bearings at the rear axle **VW** Golf 4, **SKODA** Oktavia since 1997, **SEAT** Leon, Toledo since 2001
- May be used with HAZET 4932-17 and 4925-2504/2 for tight silent blocks
- Spindle M 12 x 1.5, max. capacity 5 tons
- **Set of 3 pieces**

4925-27, -29 (2x)

**Made in Germany**

HAZET No.	l mm	EAN-No. 4000896+
4925-27/3	422	168002

### Spindle Set



**Made in Germany**

HAZET No.	l mm	EAN-No. 4000896+
4925-27/3	422	168002

- For operation of the Tool Sets for Silent Blocks 4929-2901/4 2902/3 2903/2 2904/4 4925-2504/9
- Motion screw thread at the spindle and axial groove bearing at the pressure nut cause high tractive and compressive output by low expenditure of force (torque)
- **Set of 3 pieces:**
  - spindle TR 12 x 1.5
  - nut with axial bearings 24
  - hexagon nut

4929-1/3 225 156900

### Tool Set for Silent Blocks



### Tool Set for Silent Blocks

- To be used together with 4929-1/3
- Surface: galvanized, yellow passivated (free from Cr 6)

**Made in Germany**

HAZET No.	EAN-No. 4000896+
4929-2901/4	156825

- Pressure pieces for extracting and inserting the **ball joint at the rear wheel carrier**  
**BMW** types:  
5-series: E39 – E60 – E61 – E70  
6-series: E63 – E64  
7-series: E38 – E65 – E66 – E67  
8-series: E52
- **4 pieces, contents:**  
4929-4 Support Bushing  
4929-5 Support Disc  
4929-6 Extraction Pressure Piece  
4929-7 Insertion Pressure Piece

HAZET No.	EAN-No. 4000896+
4929-2901/4	156825



- To be used together with 4929-1/3
- Surface: galvanized, yellow passivated (free from Cr 6)

**Made in Germany**

HAZET No.	EAN-No. 4000896+
4929-2902/3	156795

- Tools for extracting and inserting the **ball joint and rubber mounting at the longitudinal control arm**  
**BMW** types:  
3-series: E36 – E46 – E83  
5-series: E39 – E60 – E61 – E70  
6-series: E63 – E64  
7-series: E38 – E65 – E66 – E67  
8-series: E31 – E52  
Z4: E85 – E86
- **3 pieces, contents:**  
4929-8 Extraction Spacer Sleeve  
4929-9 Extraction Piece  
4929-11 Insertion Spacer Sleeve

HAZET No.	EAN-No. 4000896+
4929-2902/3	156795



- To be used together with 4929-1/3
- Surface: galvanized, yellow passivated (free from Cr 6)

**Made in Germany**

HAZET No.	EAN-No. 4000896+
4929-2903/2	156801

- For extracting and inserting the **rubber mounting at the rear axle carrier bottom, screw connection of the rear-axle transmission**  
**BMW** types:  
3-series: E36 – E46 – E83  
8-series: E31  
Z4: E85 – E86

- To be used together with 4929-1/3

- **2 pieces, contents:**  
4929-12 Spacer Sleeve  
4929-13 Pressure Piece  
to be used together with 4929-14 and 4929-18

HAZET No.	EAN-No. 4000896+
4929-2903/2	156801







## Tool Set for Silent Blocks

- To be used together with 4929-1/3
- Surface: galvanized, yellow passivated (free from Cr 6)

**Made in Germany**

<b>HAZET</b> No.	EAN-No. 4000896+
---------------------	---------------------

- For extracting and inserting the **rubber mounting at the front and rear gearbox mounting of the rear axle**

**BMW types:**

- 1-series: E81 – E87
- 3-series: E36 – E46 – E83 – E90 – E91 – E92 – E93
- 5-series: E60 – E61
- 6-series: E63 – E64
- 7-series: E38 – E65 – E66 – E67
- 8-series: E31
- Z4: E85 – E86

**MINI type:** Cooper S: R53

- 4 pieces, contents:**

- 4929-14 Bushing
- 4929-15 Extraction Pressure Piece
- 4929-16 Insertion Pressure Piece
- 4929-17 Insertion Pressure Plate

4929-2904/4

156788

## Universal Tool Set for Silent Blocks and Joint Bearings

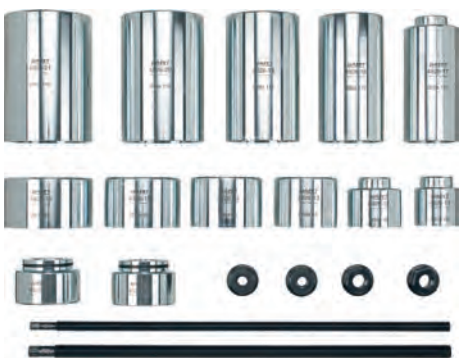

- For the professional installation and removal of silent blocks and joint bearing with a  $\varnothing$  of 40–71 mm, mechanical drive with enclosed spindles (from inside bore  $\varnothing$  of min. 10 mm on)
- May be used optionally with Hollow Piston Cylinder HAZET 4932-17
- Usage of a press frame enables installation and removal of silent block bushings etc. in ball joints.

- 19 pieces, contents:**

- 2 Receiving adapters
- Feed shaft 4926-23M10 (max. capacity 5 tons) M 10 x 1.25 with nuts
- Feed shaft 4926-24M14 (max. capacity 9 tons) M 14 with nuts
- Pressure sleeves, short:  $\varnothing$  40,  $\varnothing$  50,  $\varnothing$  58,  $\varnothing$  66,  $\varnothing$  70,  $\varnothing$  80 mm
- Pressure sleeves, long:  $\varnothing$  50,  $\varnothing$  60,  $\varnothing$  68,  $\varnothing$  76,  $\varnothing$  80 mm

**Made in Germany**

<b>HAZET</b> No.	EAN-No. 4000896+
---------------------	---------------------

4926-1/19

164493

## Universal Pressure Sleeve Set

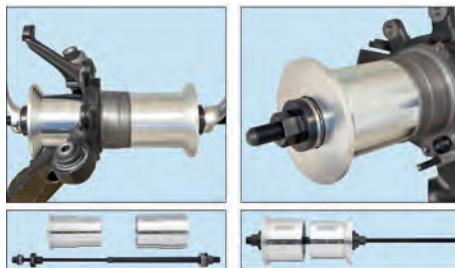

- For extracting and inserting silent blocks, hydraulic mounts, ball bearings, rubber mountings as well as bushings, shaft seals etc.
- Optimal for various vehicles, e.g. vans, off-road and commercial vehicles
- Pressure sleeves from 74 up to 112 mm  $\varnothing$
- Set of 36 pieces**

<b>HAZET</b> No.	EAN-No. 4000896+
---------------------	---------------------

4926-1/36

161058

## Press Frame for the Universal Tool Set for Silent Blocks and Joint Bearings



- Expansion set, 6 pieces**, for the hydraulic operation of the Universal Tool Set for Silent Blocks and Joint Bearings 4926-1/19 together with HAZET Hollow Piston Cylinder HAZET 4932-17
- For installation and removal of silent block bushings etc. in ball joints

**Made in Germany**

<b>HAZET</b> No.	EAN-No. 4000896+
---------------------	---------------------

4926-2/6

164486

## Cardan shafts

### Forcing Screw



- For separating by force the outer homocinetic joint of the axle drive shaft on **VW, AUDI, SEAT** or **SKODA**, e.g. when replacing axle boots
- Quick and problem-free working even on pasted homocinetic joints
- The outside hexagon  $s$  21 mm as well as the inside square  $12.5 = \frac{1}{2}$ " allow flexible application of different operating tools

**Made in Germany**

<b>HAZET</b> No.	l mm	mm	EAN-No. 4000896+
2515-1	108	M 14 x 1.5	087549
2515-2	120	M 16 x 1.5	087556

## Clamp Pliers for Axle Boots



- For installing **axle boots made of Hytrel** and clamps made of special steel with pre-set **torque values**, in conjunction with e.g. Torque Wrench HAZET 6110-1 CT
- For **VW, AUDI, SEAT, SKODA, OPEL, FORD**, etc.
- Ergonomically shaped **2-component plastic handle covers**

**Made in Germany**

<b>HAZET</b> No.	l mm	EAN-No. 4000896+
---------------------	---------	---------------------

1847

178

050918

Pair of clamping jaws for steering gear boots on **AUDI A4 / A5 / A6 / A7 / Q5** be used with HAZET 1847 (re-equipment)

1847-02/2

–

174447



### Clamp Pliers for Steering Gear Boots

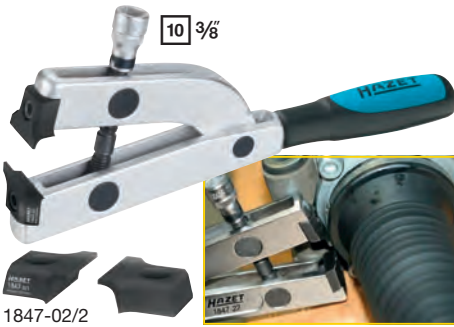

#### For AUDI steering gear boots

- For installing high-strength steering gear boots and special steel clamps with pre-set torque values (please follow the instructions of the manufacturer), in conjunction with e.g. Torque Wrench HAZET 6110-1 CT
- **AUDI A4 / A5 / A6 / A7 / Q5**
- Ergonomically shaped 2-component plastic handle covers
- □ drive 10 = 3/8"

**Made in Germany**

HAZET No.	l mm	EAN-No. 4000896+
1847-22	178	175185

Pair of clamping jaws for steering gear boots on **AUDI A4 / A5 / A6 / A7 / Q5** be used with HAZET 1847 (re-equipment)

1847-02/2	-	174447
-----------	---	--------

### Clamp Pliers for Axle Boots



- For **axle boot clamps** on passenger cars, e.g. on **VW, AUDI, OPEL, BMW, MERCEDES-BENZ, HONDA, NISSAN, MAZDA**
- With lug holding-down device
- Surface: nickel-plated

**Made in Germany**

HAZET No.	l mm	EAN-No. 4000896+
1847-1	230	007004

### Hose Clamp Pliers



### Hose Clamp Pliers

- For progressively adjustable clamps without lug holding-down device, e.g. for axle boots on **VW, AUDI, MERCEDES-BENZ** and **TOYOTA**

**Made in Germany**

HAZET No.	l mm	EAN-No. 4000896+
1847-11	191	079520

### Screwdriver Socket



- For **inside hexagon screws**
- □ drive 12.5 = 1/2"
- For screwed connections on joint flanges **VW Passat, AUDI**

**Made in Germany**

HAZET No.	l1 mm	l2 mm	S mm	EAN-No. 4000896+
2584	32	70	6	017041

### Locking Pliers



- For circlips on **outside lockrings** (shafts) e.g. on gearboxes
- **Bent tips, chequered (90°)**
- Surface: chrome-plated

**Made in Germany**

HAZET No.	l mm	EAN-No. 4000896+
1847-2	200	007011



- For circlips on **outside lockrings** (shafts) on **VW, AUDI**, e.g. outside homocinetic joint
- **Spitzen kariert, 10° abgewinkelt Bent tips, chequered (10°)**
- Surface: chrome-plated

**Made in Germany**

HAZET No.	l mm	EAN-No. 4000896+
1847-3	200	007028

### Lockring Pliers



- For circlips, e.g. on **cardan shafts and gearboxes** especially on **VW**
- Esp. for Golf: exterior cardan/bearing shafts and transmission shaft rings of the cardan shaft T 4: flanged shaft **AUDI 80**: exterior cardan/bearing shafts
- **Bent tips (30°)**
- Surface: chrome-plated

**Made in Germany**

HAZET No.	l mm	EAN-No. 4000896+
1847-6	200	050468



- For circlips on **cardan shafts and gearboxes** on flanged shaft or cardan shaft
- Especially on **VW** e.g. **VW T 4** and **T 2**
- **Bent tips (30°)**
- Surface: chrome-plated

**Made in Germany**

HAZET No.	l mm	EAN-No. 4000896+
1847-61	200	058761

### Wheels / Tyres

#### Telescopic Wheel Nut Wrench



- Solid telescopic part, drop forged
- With □ square drive 12.5 = 1/2"
- For sockets of the series HAZET 900
- Surface: chrome-plated

**Made in Germany**

HAZET No.	S mm	l1 mm	l2 mm	EAN-No. 4000896+
772	12.5	303	535	030897





### Telescopic Wheel Nut Wrench

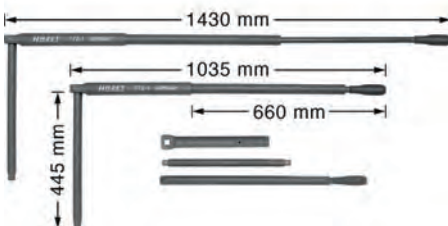

#### For installing and removing wheel nuts and bolts on commercial vehicles

- Safety pin avoids unintentional loosening – removing of safety pin with pin  $\varnothing$  3 mm
- 8-point extension for deeply located screwed connections
- Extended up to 1200 Nm
- Cold-insulated handle
- **3 pieces** – tool can be disassembled and allows space-saving storage in the storage or tool box
- For the operation of  $\square$  sockets, e.g. HAZET 1000 S
- The fitting accuracy of interior and exterior tube provides exact and safe fit in every length
- Special welding method provides force-fit connection of inside square  $\square$  and exterior tube
- Surface: burnished

**Made in Germany**

HAZET No.	S mm	$l_1$ mm	$l_2$ mm	EAN-No. 4000896+
772-1	20 $\frac{3}{4}$ "	1035	1430	123957

### Universal Axle and Slotted Nut Wrench Set

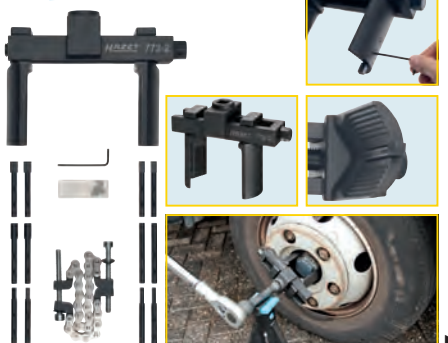

### Universal Axle and Slotted Nut Wrench Set



- For the removal and precise installation of nearly all common axle nuts, e.g. hexagon nuts, 8-point nuts, slotted nuts, face nuts, round nuts with drilled holes, round nuts with pin holes, etc.
- Clamping range: from 35 up to 170 mm
- Max. torque 700 Nm
- $\square$  drive 20 =  $\frac{3}{4}$ "
- 16 pieces in Safety-Insert-System 2-component soft foam insert

(1/3)

HAZET No.	EAN-No. 4000896+
772-2/16	161041

### Rim Wrench

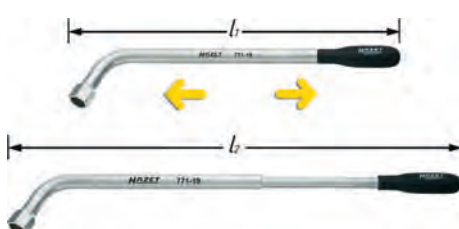

- Telescoping
- Surface: chrome-plated

**Made in Germany**

HAZET No.	S mm	S" mm	$l_1$ mm	$l_2$ mm	EAN-No. 4000896+
771-17	17	-	364	520	030798
771-19	19	$\frac{3}{4}$	380	535	030828

### Balance Weight Pliers



- For installing, removing and cutting **balance weights**
- Also for expanding and compressing the retaining springs
- Surface: chrome-plated

**Made in Germany**

HAZET No.	$l$ mm	EAN-No. 4000896+
665	245	029204



- For installing, removing and cutting **balance weights**
- Also for expanding and compressing the retaining springs
- **With plastic head** at the hammer side
- Especially for lacquered weights
- Surface: chrome-plated

**Made in Germany**

HAZET No.	$l$ mm	EAN-No. 4000896+
665-1	245	029228



Plastic hammer head for 665-1 and 665-2		
665-01	-	029211

### Four-Way Rim Wrench



- For passenger cars, vans and people carriers
- 705 V-02 additionally equipped with  $\blacksquare$  12.5 =  $\frac{1}{2}$ " for sockets of the 900 series
- Surface: chrome-plated
- DIN 3119, ISO 6788

**Made in Germany**

HAZET No.	S mm	EAN-No. 4000896+
705 N	17 x 19 x $1\frac{15}{16}$ x 21	029389
705 V-02	17 x 19 x 22 x $1\frac{123}{16}$	029396



- For passenger cars, people carriers and agricultural machinery
- **High capacity**
- **Tested up to 500 Nm**
- Forged central piece
- With  $\blacksquare$  12.5 =  $\frac{1}{2}$ " for sockets of the 900 series
- Surface: chrome-plated, heads polished
- DIN 3119, ISO 6788

**Made in Germany**

HAZET No.	S mm	EAN-No. 4000896+
715-01	17 x 19 x 22 x $1\frac{123}{16}$	029464



- For commercial vehicles, tractors, agricultural and building machinery
- **Tested up to 2000 Nm**

- 720 S with  $\blacksquare$  20 =  $\frac{3}{4}$ " for sockets of the 1000 series
- Forged central piece
- Surface: chrome-plated, heads polished
- DIN 3119

**Made in Germany**

HAZET No.	S mm	EAN-No. 4000896+
720-30	24 x 27 x 30 x 32	029518
720 S	24 x 27 x 32 x $20\frac{3}{4}$	029532

### Tire Iron



- Double-T profile ensures high stability
  - Surface: chrome-plated
- Made in Germany**

HAZET No.	l mm	EAN-No. 4000896+
For motorcycles		
650-8	199	028672
For passenger cars and vans		
650-12	303	028627
650-16	396	028634
650-20	500	028641
650-24	598	028658

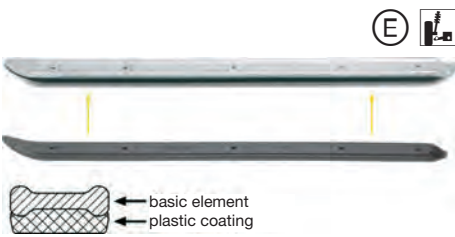

- For installing and removing tires
  - For steel and aluminium rims
  - With replaceable **plastic coating** fixed by screws
  - Surface: chrome-plated
- Made in Germany**

HAZET No.	l mm	EAN-No. 4000896+
650 K-20	500	028696



- For commercial vehicles, agricultural and building machinery
  - Heavy design
- Made in Germany**

HAZET No.	l mm	EAN-No. 4000896+
652	600	028702



- Especially for tubeless tires
  - Heavy design
- Made in Germany**

HAZET No.	l mm	EAN-No. 4000896+
653	456	028719

### Valve Tool



### Valve Tool



- For installing and removing tire valve cores
  - For pushing in the valve pin when deflating the tire, e.g. on passenger cars, transporters and commercial vehicles
- Made in Germany**

HAZET No.	EAN-No. 4000896+
666-1	087136

### Tire Tread Depth Gauge



- Glare-free reading
  - Measuring depth 30 mm
  - Graduation in 0.1 mm steps for an exact determination of the tread depth
  - Light weight and easy handling
  - Very robust – made of hard brass
  - In practical storage case
- Made in Germany**

HAZET No.	EAN-No. 4000896+
666-5	129164

### Pliers for Wheel Nut Caps

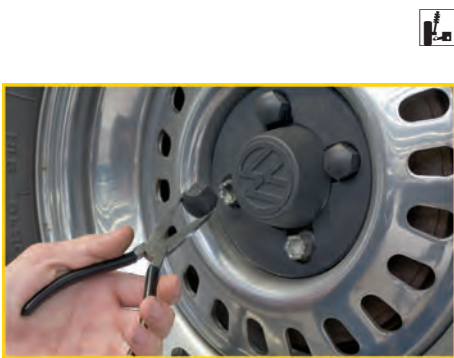

- Enables the damage-free removal of wheel nut caps on aluminium rims, e.g. on **AUDI, VW** and **OPEL**
  - The pliers' jaw tips are especially shaped for the nut caps
  - Surface: bright chrome-plated, handles dip-insulated
- Made in Germany**

HAZET No.	l mm	EAN-No. 4000896+
666-10	160	110575

### Universal Axle Lever



- For the removal of ball joints, transverse control arms and further axle components
- Various applications; pivoting and 6 position adjustment

HAZET No.	EAN-No. 4000896+
654-1	161089

### Steering Tie Rod Wrench



**For the operation of the steering tie rod screws at the steering gear side**

- For controlled screw tightening use a torque wrench with 12.5 mm = 1/2" drive, e.g. HAZET 6121-1 CT

Application: among others **VW T4, Bora 1998-2005, Golf 4, 1997-2006**

**Made in Germany**

HAZET No.	l mm	S mm	EAN-No. 4000896+
2526-34	104	34	159345



**For the operation of the steering tie rod screws at the steering gear side**

- For controlled screw tightening use a torque wrench with 12.5 mm = 1/2" drive, e.g. HAZET 6121-1 CT

Application: among others **VW Passat B5, Golf 5/Plus, Touran** as well as **AUDI A3, A5, A6, A8**

**Made in Germany**

HAZET No.	l mm	S mm	EAN-No. 4000896+
2526-38	70	38	158539





# Electricity / Battery Service

Tools for the following application fields:

- ✓ Electrical Testing
- ✓ Battery Service
- ✓ Connections / Plug Connections
- ✓ Generator



Page 119

## Electrical Testing



### Testing Set



- Test appliance for car electrics and electronics
- For **trouble shooting on electronic components**
- **3 – 48V**
- Tension indication with 2 LED (= tension and positive or negative pole)
- Probe tip, needle with sliding mechanism, additional set of crocodile clip and probe tip
- Cable length 130 cm
- **Set of 3 pieces**

HAZET No.	l mm	EAN-No. 4000896+
<b>Test appliance</b> for car electricity and electronic		
<b>2152/3</b>	156	013098
Basic appliance		
<b>2152</b>	156	013067
Crocodile clip only		
<b>2152-01</b>	62	013074
Probe tip only		
<b>2152-02</b>	98	013081

## Electronic Multifunction Tester



### With LED display and integrated lighting

- Especially for workshops (motorcycles, passenger cars, commercial vehicles, boats)
- 12 – 24 V
- Cable length 6 m with integrated lighting
- Short circuit proof 7.5 A
- Application:  
For testing electrical components, e.g. electrical fuel pumps, relays, lamps, window lift engines, etc.
- **Optimal lighting of inspection area**
- **Several acoustical signals**
- **Immediate checking of polarity due to LED-display red / green**
- Detects bonding defaults
- Continuity test: e.g. relays, safety fuse, switches, wiring, etc.
- Self-testing function

**Made in Germany**

HAZET No.	EAN-No. 4000896+
<b>2152-5</b>	144440



### Car Light Tester



- With probe tip (10 mm long) and protective cap
  - Cable with crocodile clip
  - 6–24 V
- Not to be used on vehicles with electronic components.  
For vehicles with electronic components see HAZET 2152/3

**Made in Germany**

<b>HAZET</b> No.	EAN-No. 4000896+
2153	013111

### Battery Service

#### Battery Filler



**Made in Germany**

<b>HAZET</b> No.	EAN-No. 4000896+
4650-0	022007

#### Acid Tester



- For controlling the acid content of the battery fluid
- With aerometer

**Made in Germany**

<b>HAZET</b> No.	EAN-No. 4000896+
4650-1	022014

#### Pole and Battery Terminal Puller

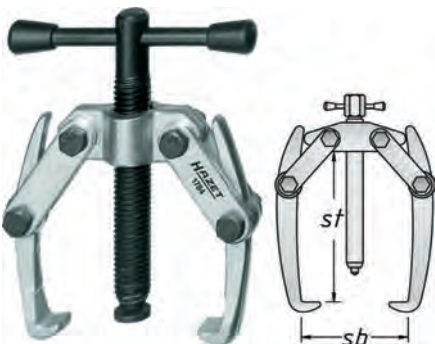

- Optimally suited for the removal of small parts such as battery terminals, ball bearings, pulleys, sprockets, etc.
- Automatic gripping of hooks
- Manageable and rugged design, with drop-forged hooks
- 2-arm design

**Made in Germany**

<b>HAZET</b> No.	Max. to.	sb mm	st mm	Spindel	EAN-No. 4000896+
1784-40	0.5	60	40	M 10 x 1.5 x 60	133482

### Special Tool for Battery Plugs



- For screwing battery plugs in and out
- Profile is especially suitable for battery plugs
- Special length allows universal application in areas with restricted access
- Ergonomic T-handle made of plastic
- Surface: chrome-plated

<b>HAZET</b> No.	EAN-No. 4000896+
4650-3	102051

### Battery Pole and Terminal Brush



**Made in Germany**

<b>HAZET</b> No.	EAN-No. 4000896+
4650-4	022038

### Battery Cell Tester



- Fast diagnosis of the charging system and state of the battery
- Measuring range 6 and 12 volt for the application on passenger cars and motorcycles

<b>HAZET</b> No.	EAN-No. 4000896+
4650-5	022045





Connections / Plug Connections

SYSTEM-Release-Tool Assortment

HAZET SYSTEM Release Tools

- ✓ For professional working
- ✓ High ease of use
- ✓ Safe application

For damage-free releasing plug-type connectors, e.g. flat and round connectors

- OEM quality "Made in Germany"
- Malfunctions due to loose contacts can be remedied easily, quickly and professionally
- Universal application in the field of car electricity
- With sliding caps protecting the blades from damage and avoiding the risk of injury

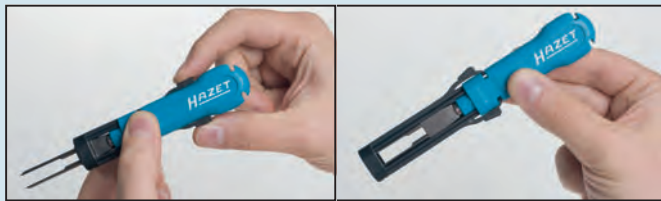
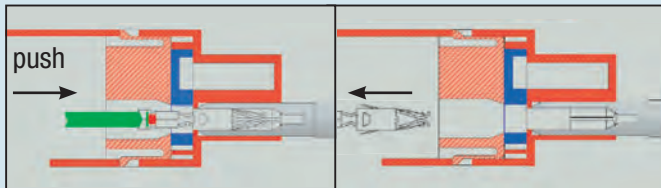

- Extension set for VW – AUDI – SEAT – SKODA
- 10 pieces, in plastic case with soft foam insert
- Made in Germany

Contents:  
4671-9 10  
4672-11 12 13 14 15  
4673-12 13  
4674-4

HAZET No.	EAN-No. 4000896+
4670-4/10	135530

SYSTEM-Release-Tool Assortment



- Basic Set for about 80 % of all plug-type connections in passenger cars
- 12 pieces, in plastic case with soft foam insert
- Made in Germany

Contents:  
4671-1 2 3  
4672-1 2 3 4  
4673-1 2 3 4 5

HAZET No.	EAN-No. 4000896+
4670-1/12	132898



- Extension set for DAIMLER/CHRYSLER
- 12 pieces, in plastic case with soft foam insert
- Made in Germany

Contents:  
4671-4 5 11  
4672-5 6 7 16 19 20  
4674-1 7 8

HAZET No.	EAN-No. 4000896+
4670-5/12	135646

**SYSTEM-Release-Tool Assortment**



- Extension set for trucks/commercial vehicles
- 9 pieces, in plastic case with soft foam insert

**Made in Germany**

Contents:

- 4671-4 15 16
- 4672-19 21 22
- 4673-12
- 4674-9 10

HAZET No.	EAN-No. 4000896+
4670-6/9	135776

**SYSTEM-Release-Tool**



**Made in Germany**

HAZET No.	EAN-No. 4000896+
ABS 4.0 mm round connector 4671-1	135219
3.5 mm round connector system 4671-2	135288
1.5 mm round connector system 4671-3	135295
2.5 mm round connector 4671-4	135394
LKS 1.5 mm pin-side 4671-5	135400
LKS 1.5 mm bush-side 4671-6	135417
Release tool for round connector system 3.5 mm 4671-9	135622
Release tool for round connector system antenna contact 4671-10	135639
ABS mounting help 4671-11	135653
ABS bushing 4671-15	135837
Round connector system 4671-16	135844

**SYSTEM-Release-Tool**







Ingenious Tools

Specialty Tools – Electricity/Battery Service – Connections/Plug Connections

SYSTEM-Release-Tool



Made in Germany

HAZET No.	EAN-No. 4000896+
Micro Timer II 4672-1	135042
Maxi Power Timer 4672-2	135073
Pit Pod/Faston 6.3 mm 4672-3	135097
JPT/ SPT 4672-4	135165
MLK 1.2 mm 4672-5	135325
SLK 2.8 mm P 4672-6	135356
LSK 8 4672-7	135370
Sicma contact 2.8 mm 4672-8	135387
MCP 1.5 mm/contact width 1.5 mm 4672-11	135561
Flat connectors with 2 snap-in pins/contact width 4.8 mm (e.g. ISO-connector car radio) 4672-12	135578
Flat connectors with one housing catch/contact width 6.3 mm 4672-13	135585
DCS 2 contact 4672-14	135592
Flat connectors with 2 snap-in pins/contact width 2.8 mm 4672-15	135615
E-95 4672-16	135677
MCP 4.8 mm 4672-19	135714
MCP 2.8 mm 4672-20	135738
MCP 9.5 mm 4672-21	135790
Ducon 9.5 4672-22	135813

SYSTEM-Release-Tool



Made in Germany

HAZET No.	EAN-No. 4000896+
Micro Standard 4673-1	134946
Standard 2.72 mm 4673-2	134953
Standard 1.48 mm 4673-3	134977
Standard Timer 1.89 mm 4673-4	134991
Release tool for secondary locking 4673-5	135301
Additionally for single groove JPT contacts 4673-6	135332
Leaf spring connector (Micro-Timer) 4673-7	135349
Secondary locking FCI 4673-8	135424
Flat connectors with one lock catch (various contact widths) Yazaki 1.5 and 2.8 4673-12	135547
Flat connectors with housing catch 4673-13	135554

Electricity / Battery Service

**SYSTEM-Release-Tool**

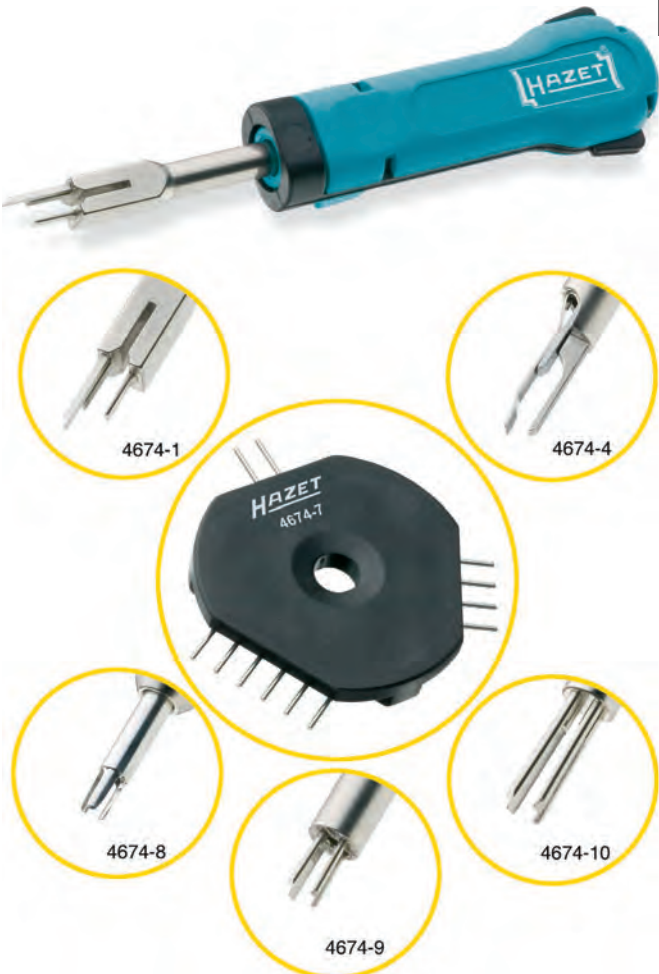

**Made in Germany**

HAZET No.	EAN-No. 4000896+
SLK 2.8 mm P & S <b>4674-1</b>	135363
Flat connectors with 2 snap-in pins/contact width 6.3 mm <b>4674-4</b>	135608
GSK combi <b>4674-7</b>	135721
Pin 5-7 pins <b>4674-8</b>	135769
MKS/ MKR 1.5 <b>4674-9</b>	135806
VKR contact <b>4674-10</b>	135868

**Generator**

**Pulley Extractor**



**Pulley Extractor**



- For pulleys of passenger cars
- Especially suitable for areas with restricted access

**Application:**

Extractor for pulleys **with thread holes**, application with:

- 1 crossbar, short, for pulleys 43–120 mm Ø
- 1 crossbar, long, for pulleys 95–210 mm Ø
- 3 exchangeable pressure pieces, serving as spindle extension

Extractor for pulleys **without thread holes** (hook grip behind pulley), application with:

- 1 crossbar, short, for pulleys 23–100 mm Ø
- 1 crossbar, long, for pulleys 85–195 mm Ø
- Puller hooks for a span depth up to 68 mm or extension up to 88 mm

Extractor with **2 groove hooks** (fit into the grooves of the pulley, if gripping behind is not possible), application with:

- 1 crossbar, short, for pulleys 80–140 mm Ø
- 1 crossbar, long, for pulleys 135–235 mm Ø

**Made in Germany**

HAZET No.	EAN-No. 4000896+
<b>1789 N-1</b>	158621

**V-Ribbed Belt Pulley Adapter**



- Adapter with internal serration XZN for installing or removing the **V-ribbed belt pulley** at the generator,
- For e.g. VALEO, BOSCH etc. on **VW, AUDI, SKODA** and SEAT

**Made in Germany**

HAZET No.	mm	l mm	S mm	EAN-No. 4000896+
<b>2592</b>	17	30	19.6	057443

**V-Ribbed Belt Pulley Tool**



- For installing and removing the **V-(ribbed) belt pulley** at the generator
- Application on **VW, AUDI, SKODA, SEAT, PORSCHE, MERCEDES-BENZ, FORD, VOLVO**, etc.
- **Set of 2 pieces** consisting of adapter with internal serration HAZET 2592 and screwdriver socket HAZET 2751 (M 10)

**Made in Germany**

HAZET No.	EAN-No. 4000896+
<b>4641/2</b>	081479





### V-Ribbed Belt Pulley Tool

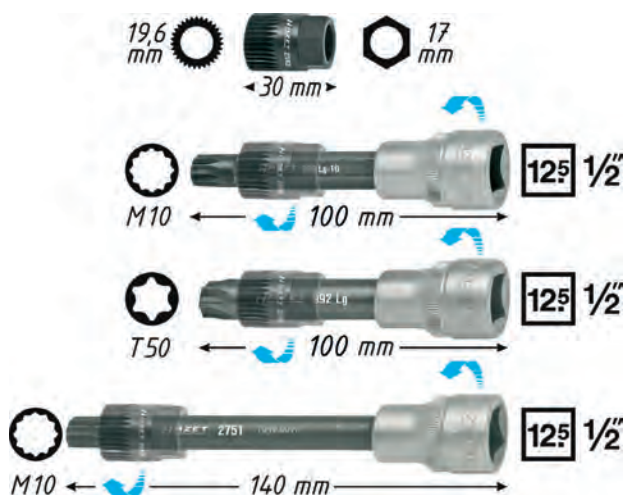

- For working on the built-in or dismantled generator
- For installing and removing the V-(ribbed) belt pulley at the generator
- Control of the screwing
- TORX® and XZN screwdriver sockets for different inside profiles
- The generator is locked with the respective screwdriver socket and the screwing of the belt pulley is operated with the adapter with internal serration
- Application on **VW, AUDI, SKODA, SEAT, PORSCHE, MERCEDES-BENZ, FORD, RENAULT, VOLVO**, etc.
- **Set of 4 pieces**

🇩🇪 **Made in Germany**

Contents:  
990 Lg-10  
992 Lg-T 50  
2592  
2751

HAZET No.	EAN-No. 4000896+
4641/4	103157

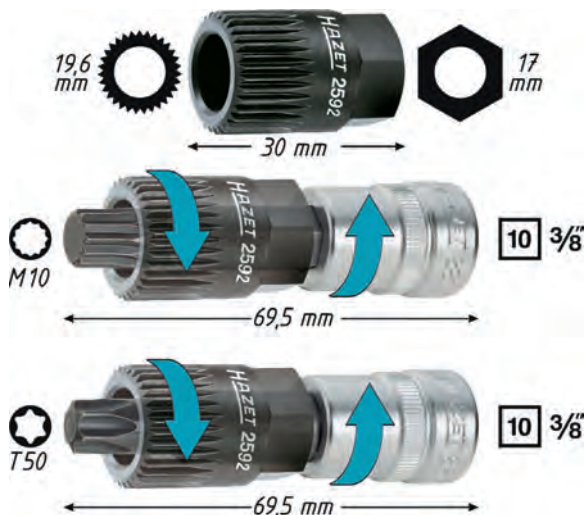

- For installing and removing the V-(ribbed) belt pulley at the **built-in** generator
- Control of the screwing
- **Extra-short** (69.5 mm) TORX® and XZN screwdriver sockets for different inside profiles
- The generator is locked with the respective screwdriver socket and the screwing of the belt pulley is operated with the adapter with internal serration
- Application, among others, on **MERCEDES-BENZ**
- **Set of 3 pieces**

🇩🇪 **Made in Germany**

Contents:  
8802 Lg-T 50 8808 Lg 70-10 2592

HAZET No.	EAN-No. 4000896+
4641 K/3	159314

### Radio Dismounting Tool



AUDI / FORD / VW	LANDROVER	AUDI / NEW BEETLE
MERCEDES-BENZ / PORSCHE	BMW	SKODA
BMW	VW	FIAT
After Market Utility	Kenwood	Sony
Blaupunkt		

**VW, AUDI, FORD, BMW, MERCEDES-BENZ, PORSCHE, GM OPEL, SKODA, FIAT, LAND-ROVER, KENWOOD, SONY, CLARION, BLAUPUNKT** and many others

**Improved execution with many additional applications**

- Universal tool for installing and removing car radios of different car and radio manufacturers
- Very handy
- **All applications in one tool** – no need to search the right tool
- Practical slide for the separation of both parts
- Many unlocking types in one compact tool

HAZET No.	EAN-No. 4000896+
4655-1	120666

# Body / Interior Equipment

Tools for the following fields of application:

- ✓ Car Body Repair
- ✓ Car Glass / Wiper Arm
- ✓ Steering Wheel / Airbag

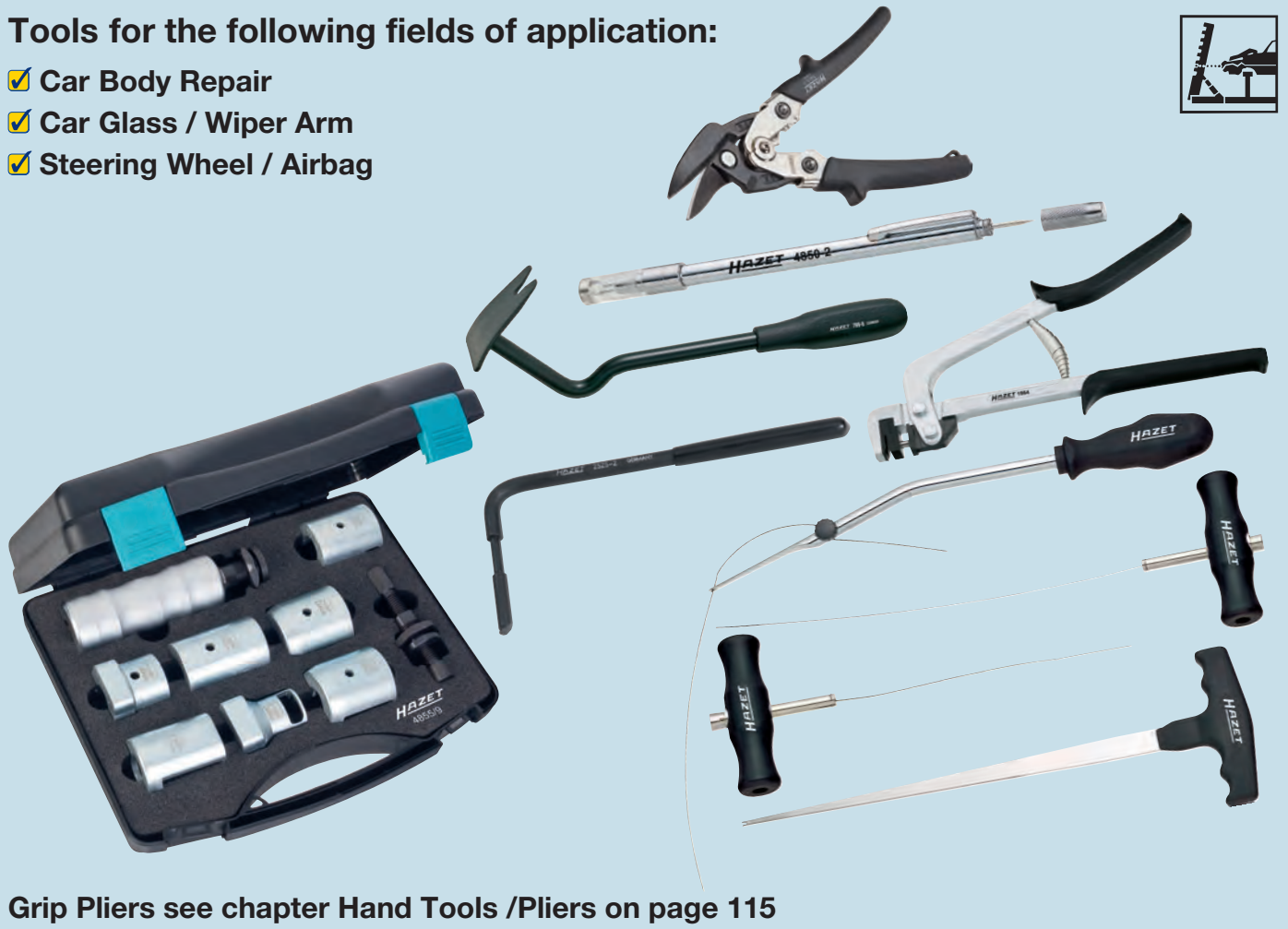

Grip Pliers see chapter Hand Tools /Pliers on page 115

## Car Body Repair

### Tool Assortment



### Tool Assortment

Assortment for car body work  
77 pieces

• For Tool Trolleys HAZET *Assistant*

Contents:

- 428-6 7 8 10 11 13
- 600 N-8 9 10 11 12 13
- 14 15 17 19 22 24
- 745 a-6 745-4
- 746-1 757-10
- 760 N-2 799-3
- 801 K-55
- 803-25 55 65 80 100
- 803-PH 1 PH 2 PH 3
- 821-2
- 900-10 11 12 13
- 15 17 19 22
- 916 SP 917-5 918-10
- 1810-250 1850-44
- 1917 N 1919 N
- 1920 N 1921
- 1922 1923
- 1927 1929-1
- 1930 1931
- 1934
- 1934-1 4 9 10
- 1937 K 1940
- 1950 1960-5
- 1961 L-2 1961 R-2
- 1965-1 2 3 4 5
- 2130 2140-3 5
- 2143 2150
- 2165-1 2

HAZET  
No.

0-1900/77

EAN-No.  
4000896+

000241





## Specialty Tools – Body/Interior Equipment – Car Body Repair

### Body and Fender Tool Set



759 x 305 x 115 mm

- For car body work
- In sheet metal box (HAZET-blue)
- 10 pieces

**Made in Germany**

Contents:

1911	1917 N	1919 N	1928 K
1930	1931	1934	1935
1938 K	1940		

HAZET No.	EAN-No. 4000896+
1905/10 N	007448

### Hand Anvil (Dolly)



- Roof wedge-shaped
- Length 137 mm, width 55 mm

**Made in Germany**

HAZET No.	EAN-No. 4000896+
1911	007486



- Daimler Stöckle
- 110 x 50 mm, height 50 mm

**Made in Germany**

HAZET No.	EAN-No. 4000896+
1917 N	007509



- Wedge-shaped
- 110 x 63 mm

**Made in Germany**

HAZET No.	EAN-No. 4000896+
1918 N	007516



- Toe-shaped
- 120 x 58 mm, height 20 mm

**Made in Germany**

HAZET No.	EAN-No. 4000896+
1919 N	007523

### Hand Anvil (Dolly)



- Universal
- 76 x 56 mm and 65 x 47 mm, height 60 mm

**Made in Germany**

HAZET No.	EAN-No. 4000896+
1920 N	007530



- All-sides ground
- Heel-shaped, flat / halfround
- 84 x 62 mm, height 34 mm

**Made in Germany**

HAZET No.	EAN-No. 4000896+
1921	007554



- "Diabolo" style
- 59 x 61 mm, height 59 mm

**Made in Germany**

HAZET No.	EAN-No. 4000896+
1922	007561

### Box File



- For body sheet planishing
- All sides with cut of a file
- 158 x 35 x 25 mm

**Made in Germany**

HAZET No.	EAN-No. 4000896+
1923	007578

### General Purpose Spoon



- Blade size 52 x 150 mm

**Made in Germany**

HAZET No.	l mm	EAN-No. 4000896+
1927	275	007691

### General Purpose Spoon



- Cut on one side
- Blade size 60 x 30 x 200 mm

**Made in Germany**

HAZET No.	l mm	EAN-No. 4000896+
1928 K	385	007707



- Wide shape
- Offset and curved
- Blade size 170 x 50 mm

**Made in Germany**

HAZET No.	l mm	EAN-No. 4000896+
1929-1	480	007721



- Wide shape
- Deep offset and heavily curved

**Made in Germany**

HAZET No.	l mm	EAN-No. 4000896+
1930	455	007738



- Narrow shape
- Blade size 105 x 85 x 38 mm

**Made in Germany**

HAZET No.	l mm	EAN-No. 4000896+
1930-1	315	007745

### Bending Iron



- With leather cap

**Made in Germany**

HAZET No.	l mm	EAN-No. 4000896+
1931	410	007769

### Flange Tool



- Forms crimped edges on sheet metals up to 1 mm thickness
- **Crimping capacity: 12 mm**
- Plastic handle covers
- Surface: chrome-plated

**Made in Germany**

HAZET No.	b mm	l mm	EAN-No. 4000896+
1932-1	15	300	007806
1932-2	30	300	007868

### Sheet Metal Punch



- For sheet metal punching up to 1 mm during spot-welding (MAG-welding)
- Plastic handle covers

To be used with HAZET Flange Tool 1932

- Surface: chrome-plated

**Made in Germany**

HAZET No.	Ø mm	l mm	EAN-No. 4000896+
1964-50	5	300	009039
1964-55	5.5	300	009077
1964-70	7	300	009121

Replacement punching set consisting of: punch, die plate, screw and headless screw for 1964-50

1964-050	-	-	008995
ditto for 1964-55	-	-	009008
1964-055	-	-	009008
ditto for 1964-70	-	-	009015
1964-070	-	-	009015

### Car Body Chisel



- For cutting sheet metal, welding spots, welding grooves, etc.
- With hand guard (730 HS)
- Blade size: 7 x 26 mm

**Made in Germany**

HAZET No.	l mm	EAN-No. 4000896+
1960-5	240	008759

### Sheet Metal Profile Snips



- For figure cutting and short, straight cuts
- For sheet metal up to 1.8 mm, VA-steel sheets up to 1.2 mm
- With lever transmission system
- Handles with plastic cover
- Shear head drop-forged, hardened and tempered
- Cutting edges induction hardened

**Made in Germany**

HAZET No.	l mm	EAN-No. 4000896+
R = right hand cutting 1961 R-1	260	008803
L = left hand cutting 1961 L-1	260	008780



- For figure cutting and straight cuts
- With lever transmission system
- Handles with plastic cover
- Shear head drop-forged, hardened and tempered
- Cutting edges induction hardened

**Made in Germany**

HAZET No.	l mm	EAN-No. 4000896+
R = right hand cutting 1961 R-2	260	008810
L = left hand cutting 1961 L-2	260	008797

### Hand Riveting Tool



- For safe and fast rivet joints
- For aluminium **blind rivets** up to 5 mm Ø, and steel blind rivets up to 4 mm Ø
- Three jaw chuck allows an optimal riveting process
- Rivet is fixed automatically when inserting the nose piece
- Quick changing of nose pieces due to knurling, no tools needed
- Rivet snaps off with little effort

### Hand Riveting Tool

- Solid tool construction absorbs the vibration when the mandrel breaks.

HAZET No.	l mm	EAN-No. 4000896+
1963-1	280	155675

### Car Body File Holder



- Adjustable, with tightening screw
- With 1 file blade 1934-4
- For flat file blades HAZET 1934-1 up to -5

**Made in Germany**

HAZET No.	l mm	EAN-No. 4000896+
1934	355	008018



- Made of wood
- Without file blade

**Made in Germany**

HAZET No.	l mm	EAN-No. 4000896+
For flat file blades 1934-1 up to -5 1934 N-1	525	008155
For half-round (hollow) file blades 1934-7 1934 N-2	525	008179

### Car Body File Blade



- Flat
- Milled, diagonal cut
- Teeth (cut):  
1 = coarse 1934-1  
2 = medium 1934-2  
3 = fine 1934-3
- For File Holders HAZET 1934 and 1934 N-1
- DIN 7264 form A

HAZET No.	l mm	EAN-No. 4000896+
1934-1	350	008025
1934-2	350	008063
1934-3	350	008070



- Flat
- Milled, curved cut
- Teeth (cut):  
1 = coarse 1934-4  
2 = medium 1934-5
- For File Holders HAZET 1934 and 1934 N-1
- DIN 7264 form A

HAZET No.	l mm	EAN-No. 4000896+
1934-4	350	008087
1934-5	350	008094





### Car Body File Blade



- Half-round (hollow)
- Diagonal cut
- Teeth (cut): 1 = coarse
- For File Holder HAZET 1934 N-2
- DIN 7264 form F

HAZET No.	l mm	EAN-No. 4000896+
1934-7	350	008100

### Car Body File



- Cross cut
- Teeth (cut):  
1 = coarse (1934-8)  
3 = fine (1934-9)
- Cranked
- Plastic handle

Heat the bent with a welding torch. Then work the metal with the file. Due to the special alloy, the heat will be extracted when working the metal with the file and the metal will be planished.

HAZET No.	l <sub>1</sub> mm	l <sub>2</sub> mm	EAN-No. 4000896+
1934-8	350	430	008124
1934-9	350	430	008131

- Single cut
- Teeth (cut):  
0 = coarse 1934-10

1934-10	350	430	008032
---------	-----	-----	--------

### Body Hammer



- HICKORY handle
- **Made in Germany**

HAZET No.	Hammer Head Form	l mm	EAN-No. 4000896+
-----------	------------------	------	------------------

- Bumping and planishing hammer
- 154 mm
- **2 round faces of different sizes**
- 1935     $\circ 40 \times 30$     308    008193
- Stretching and planishing hammer
- 103 mm
- **Round faces, finely chequered, milled**
- 1937 K     $\square 24 \times 32$     305    008209
- Stretching and planishing hammer
- 96 mm
- **Round faces, finely chequered, milled**
- 1938 K     $\square 35 \times 40$     310    008216

### Body Hammer



- HICKORY handle
- **Made in Germany**

HAZET No.	Hammer Head Form	l mm	EAN-No. 4000896+
-----------	------------------	------	------------------

- Planishing and embossing hammer
- 160 mm
- **Round face and ball**
- 1940     $\circ 40 \times 17$     309    008230
- Planishing and cross-peen hammer
- 135 mm
- **Round face and curved, sharp peen**
- 1943     $\circ 40 \times 15$     309    008261



- HICKORY handle
- **Made in Germany**

HAZET No.	Hammer Head Form	l mm	EAN-No. 4000896+
-----------	------------------	------	------------------

- Bumping and picking hammer
- 165 mm
- **Round face and straight peen**
- 1944     $\circ 41 \times 10$     325    008278
- Aluminium hammer
- Flat, half-round
- 1950     $\circ 30$     310    008339

### Welding Spot Drill



- For exact welding spot reaming in sheet metal fabrication
- No warped or torn materials
- 7 mm hexagon shank prevents slippage in drill chuck
- Fits power drills of all types
- Replaceable cutting crown (right-hand thread) made of high-speed steel (oiled)
- Cutting crown for use at both ends
- With screw for gauge depth adjustment (\*)
- **Made in Germany**

HAZET No.	$\varnothing$ mm	l mm	EAN-No. 4000896+
1967	11	70	009312



- Cutter crowns, set of 10 pieces for 1967
- |                     |   |   |        |
|---------------------|---|---|--------|
| 1967-01             | - | - | 009329 |
| Center tip for 1967 |   |   |        |
| 1967-02             | - | - | 009336 |

### Welding Spot Drill



- For exact welding spot reaming
- Self-cutting centring tip resharpenable
- Heavy duty, high-speed steel, blued
- **Made in Germany**

HAZET No.	$\varnothing$ mm	l mm	EAN-No. 4000896+
1967-70	7	74	009343
1967-80	8	79	009350
1967-90	9	79	009367

### Special Bumping Mallet



- With permanent plastic filler for non-damaging bumps **without striation** (\*)
- Assembly tool for materials that are susceptible to scratching
- For fixing trim strips, working on roof rails as well as seat installing, upholstery
- **Made in Germany**

HAZET No.	l mm	EAN-No. 4000896+
-----------	------	------------------

- Rubber body 70 x 70 mm
- 1959-2    260    102259
- Handle adjustable to 90°
- Rubber body 70 x 140 mm
- 1959-3    280    008728
- Handle adjustable to 90°
- White rubber body 70 x 140 mm
- 1959-4 \*    280    127221

### Wedge



- For hot galvanized surfaces
- Beech wood
- **Made in Germany**

HAZET No.	EAN-No. 4000896+
-----------	------------------

- Set of 5 pieces:  
Contents:  
1965-1 2 3 4 5  
1965/5    009220

**Wedge**



- For car body work, e.g. for stripping mouldings, covers, graphics, etc. without damage
- Plastic

Made in Germany

HAZET No.	b mm	h mm	l mm	EAN-No. 4000896+
1965-20	25	25	190	009183

**Combination Lever**



- For fast and easy removing of mouldings and door coverings
- Operation of plugs and plastic clips
- Removing of protective caps and covers
- Avoids damage of lacquered surfaces, plastic and metal parts

HAZET No.	b mm	l mm	EAN-No. 4000896+
1965-21	22	270	087839

**Extractor Hook**



- For removing the front grille of the VW – Transporter since 1991
- Removal of e.g. the additional light, interior lining, interior lighting shade etc.
- VW Golf since 2004, Golf Plus since 2005, Jetta since 2006, Crafter since 2006, Tiguan since 2008, Passat since 2006, Scirocco since 2009, AUDI A2, A3, A4, A5, A6, A8, Q5, Q7, R8
- With T-handle

HAZET No.	EAN-No. 4000896+
2520-1	075218

**Aligning Tool for Doors**



- For easy and clean re-alignment of doors on passenger cars and minivans (height adjustment) as well as tailgates on hatchback vehicles (adjustment of door gap-width)
- Flat steel Chrome-Vanadium aligning rod made of special steel
- Surface: chrome-plated

HAZET No.	l mm	EAN-No. 4000896+
-----------	------	------------------

Set of 4 pieces:  
Aligning rod with 3 pins, stored in the rod's handle

Contents:	l mm	EAN-No. 4000896+
1973-1 2 3 4		
1973-4	660	009718
Aligning Rod		
1973-1	660	009664
Pin 19 mm Ø		
1973-2	-	009688
Pin 12 mm Ø		
1973-3	-	009695
Pin 9.3 mm Ø		
1973-4	-	009701

**TORX® Screwdriver**

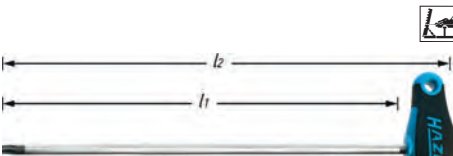

- For inside TORX® screws
- Extra long style
- With ergonomically shaped 2-component T-handle
- Surface: chrome-plated, tips burnished
- For installing and removing the door handle on MERCEDES-BENZ type 168, type 169 (A-class), type 245 (B-class) and type 203 (C-class)
- Adjustment of the headlights on MERCEDES-BENZ Actros

HAZET No.	mm	l1 mm	l2 mm	EAN-No. 4000896+
828 Lg-T 20	3.86	200	226	139941

**Bent Bit Holder for Door Hinges**



- For installing and removing the doors on VW-Golf 3 and Vento model years 1991-1997 (screwed connection door hinges) and for door alignment
  - With plug and socket connection 9x12 mm square
  - With TORX® Bit T45 (HAZET 2597-01)
- Removal in conjunction with Tool Holder HAZET 6396, installation with Torque Wrench HAZET 6290-1CT – Please follow VW torque regulations – see also HAZET 2251-1/2
- Surface: chrome-plated

Made in Germany

HAZET No.	mm	l mm	EAN-No. 4000896+
2597	7.82	95	017379

**TORX® Screwdriver Bit**



- Screwdriver Bit TORX® T 45 for 2597
- For installing and removing the doors on VW Golf and Vento since 1993

Made in Germany

HAZET No.	mm	l mm	EAN-No. 4000896+
2597-01	7.82	18	017386

**Screwdriver Bit**



- For door aligning as well as for installing and removing the doors on VW Golf 4 (model years 1997-2006) Passat B5 (model years 1996-2000) SEAT Leon (model years 1999-2006) in conjunction with Bent Bit Holder HAZET 2597
- For screws with internal serration (XZN) M 10
- Similar to DIN 65254

Made in Germany

HAZET No.	l mm	M	EAN-No. 4000896+
2597-02	21	10	066667





### Screwdriver Bit



- For door aligning as well as for installing and removing the doors on **VW Golf 5** (model years 2003-2008), **Golf 6** since 2008, **Passat** since 2005 in conjunction with Bent Bit Holder HAZET 2597
- For screws with internal serration (XZN) M 8
- Similar to DIN 65254

Made in Germany

HAZET No.	l mm	M	EAN-No. 4000896+
2597-03	21	8	118830

### TORX® Screwdriver Bit



- For installing and removing the driver's and co-driver's door on **VW Golf 3**, **Vento** since 1993
- T 45 with special length
- In conjunction with Reversible Ratchet HAZET 2264 or Torque Wrench 6290-1CT – consider **VW** torque regulations –
- Hexagon drive ISO 1173-C 6.3 = 1/4"

Made in Germany

HAZET No.	mm	l mm	EAN-No. 4000896+
2597-T 45	7.82	25	017393

### Hose Clamp Pliers



- For installing and removing the stop spring of the window crank
- Surface: chrome-plated, jaw burnished

Made in Germany

HAZET No.	Sb mm	l mm	EAN-No. 4000896+
799	8-45	210	031986

### Lever for Removing Door Panels



### Lever for Removing Door Panels



- For removing fixing plugs on door panels
- Coated for the protection of vehicle lacquer
- Jaw opening 28 mm

Made in Germany

HAZET No.	l mm	EAN-No. 4000896+
799-3	268	031993

### Pliers for Dismantling Door Panels



- For removing the fixing bolts on door panels, mouldings and bumper rubber strips
- Coated for the protection of vehicle lacquer

Made in Germany

HAZET No.	l mm	EAN-No. 4000896+
799-4	230	032013



- For removing the fixing plugs on door panels, mouldings and bumper rubber strips
- Coated for the protection of vehicle lacquer
- Among others for **VW Sharan**, **FORD Galaxy** and **SEAT Alhambra**

Made in Germany

HAZET No.	l mm	EAN-No. 4000896+
799-5	285	052042

### Lever for Removing Door Panels



- For removing the fixing plugs on door panels – **VW Sharan** since 1996, **Touareg** since 2003, **Touran** since 2004, **Phaeton** since 2003 – **SEAT Alhambra** since 1996 – **FORD Galaxy** since 1995
- Lever provides an optimal power transmission
- Coated for the protection of vehicle lacquer
- Ergonomic plastic handle

Made in Germany

HAZET No.	l mm	EAN-No. 4000896+
799-6	260	110346

### Bumper Tubular Socket Wrench



- Special tool for the operation of the rear bumper screws, **MERCEDES-BENZ** type 204 (C-Class) station wagon and limousine, **AUDI A3** since 2004, **A4** since 2001, **A6** since 2005, **TT** since 2007
- Note: Screw operation with threaded rod
- □ drive 6.3 = 1/4"
- Enables controlled screwing with the torque value required by the manufacturer

Made in Germany

HAZET No.	l mm	S mm	EAN-No. 4000896+
2797-1	160	10	154746

### Side Mirror Assembly Tool



- For installing and removing the side mirror on **MERCEDES-BENZ** type 211 (E-class) as well as type 203 (C-class) since 2005
- With T-handle
- For inside 5-star screws with centre pin

HAZET No.	l <sub>1</sub> mm	l <sub>2</sub> mm	S mm	EAN-No. 4000896+
2715-20 H	200	225	20 H	118717

**Car Glass/Wiper Arm**

**Tool Set for Removing Car Glass**



- Suitable for all glued windscreens as well as for most side and rear windows
- 4-point cutting wire for fast and easy cutting of nearly all adhesive beads
- Sawing wire twisted of three brass-plated steel wire for very hard or large adhesive beads
- Robust wire starter made of spring steel with large T-handle to pierce the wire through the bead
- Counterholder with long shaft and stable M4-thread secures the cutting wire from inside
- Self-closing safety pull handles hold the cutting or sawing wire firmly

<b>HAZET</b> No.	EAN-No. 4000896+
---------------------	---------------------

**Set of proven tools for removing glued car windows**

**6 pieces**

Contents:

4852-3 (2x) 4 5 6 7

4852/6 129447

**Pull handle**  
4852-3 129454

**Counterholder**  
4852-4 129461

**Wire starter**  
4852-5 129478

**Roll of square cutting wire** 0.6 x 0.6 mm, 22 metres  
4852-6 129485

**Roll of round cutting wire** Ø 0.8 mm, 22 metres  
4852-7 129492

**Nozzle Adjusting Tool**



**For adjusting the nozzles of the washing system**

- The telescopic handle can be used to demonstrate the jet of the nozzles to the window
- With pocket clip
- With magnetic head 6 mm Ø
- Adjusting needle and protective cap

<b>HAZET</b> No.	$l_1$ mm	$l_2$ mm	EAN-No. 4000896+
4850-1	155	670	022366

**Nozzle Adjusting Tool**



**For adjusting the nozzles of the washing system**

- The telescopic handle can be used to demonstrate the jet of the nozzles to the window
- With pocket clip
- With integrated LED for easy detection of parts in dark areas such as the engine compartment etc.
- With powerful magnet 8 mm Ø to pick up small parts

<b>HAZET</b> No.	$l_1$ mm	$l_2$ mm	EAN-No. 4000896+
4850-2	183	682	149544

**Window Extracting Knife**



- **Knife with pulling handle** and blade with 22 mm cutting depth
- For the extraction of glued **car windows**

<b>HAZET</b> No.	EAN-No. 4000896+
4852-1	050543

**Spare blades for 4852-1**  
**set of 2 pieces, 22 mm depth of cut**  
4852-01/2 051496

**Spare blades for 4852-1**  
**set of 2 pieces, 15 mm depth of cut**  
4852-02/2 056446

**Wiper Adjusting Tool**



- For angular adjustment of the wiper blades  
– Please follow the manufacturer's instructions –  
Not suitable for Aerotwin wipers

**Made in Germany**

<b>HAZET</b> No.	$b$ mm	$h$ mm	$l$ mm	EAN-No. 4000896+
4851-1	65	60	120	048212





### Wiper Arm Extractor Set



### Wiper Arm Extractor Set

- For removing wiper arms on passenger cars and commercial vehicles

**Made in Germany**

HAZET  
No.

EAN-No.  
4000896+

9 pieces, in plastic box

4855/9 111268

Extractor Claw

4855-1 111084

4855-2 111091

4855-3 111107

4855-4 111114

4855-5 111121

4855-6 111237

4855-7 111244

Drive with 6-point spindle, size 14 mm

4855-8 111251

Impact Extractor with connection piece

4855-9 110964

Vehicle Type	Claw 4855-	Drive 4855-	Claw 4855-	Drive 4855-
<b>AUDI</b>				
A 80 up to 1996	1	8		
A 2	1	8		
A 3	1	8		
A 4 up to 2001	1	8	1	8
A 4 since 2001	5	8		
A 4 since 2003	7	8		
A 6 since 1997	1	8	1	8
A 8 since 2003	2	8		
TT (Hook off the bonnet shock absorber and then steeply erect bonnet)	3	8		
<b>ALFA ROMEO</b>				
147	1	8		
156	2	8		
<b>BMW</b>				
3-series E 36	3	8		
3-series Compact E 36	1	8	3	8
3-series E 46, right	2	8		
3-series E 46, left	5	8		
5-series E 39, right	5	8		
5-series E 60, right	3	8		
7-series E 38, right	2	8		
7-series E 65, right	2	8		
Mini	7	8		
<b>CITROËN</b>				
Berlingo	1	8	1	9
C 5	4	8	6	8
Evasion	1	8	3	9
Saxo	1	8	6	8
Xsara	1	8	6	8
Xsara Picasso	2	8	6	8
<b>FIAT</b>				
Seicento	3	8	3	8
Panda	1	8	3	8
Punto	1	8	3	8
Stilo	1	8	3	8
Idea	1	8	3	8
Doblo	1	8	3	8
Ulysse	–	–	3	8
Ducato	1	8		
<b>FORD</b>				
Fiesta since 1995	1	8		
Fiesta since 2001	1	8		
Focus	2	8		
Focus C-Max	2	8		
Fusion	1	8		

Vehicle Type	Claw 4855-	Drive 4855-	Claw 4855-	Drive 4855-
<b>FORD</b>				
Ka	3	8		
Mondeo up to 2001	1	8		
Mondeo since 2001	1	8	6	8
Galaxy up to 2000	2	8	3	8
Galaxy since 2000	5	8	1	9
<b>HONDA</b>				
Accord years 1998/1999	1	8		
Civic since 2002	2	8		
<b>MERCEDES BENZ</b>				
A-Class	1	8		
C-Class	2	8		
E-Class since 2002 right	5	8		
E-Class since 2002 left	1	8		
M-Class	1	8		
SLK	4	8		
Vito / V-Class	4	8		
<b>OPEL</b>				
Astra F	3	8	3	8
Astra G	1	8	4	8
Astra G station wagon	1	8	3	8
Corsa B	3	8		
Corsa C	1	8	1	8
Meriva	–	–	3	8
Movano	1	8		
Signum	1	8	3	8
Vectra C	1	8	3	8
Vivaro	1	8		
Zafira	1	8	3	8
<b>PEUGEOT</b>				
106	1	8	6	8
206	2	8		
306	1	8		
306 Cabrio	1	8		
307	2	8	6	8
406	2	8	6	8
806	1	8		
Partner	1	8		
<b>RENAULT</b>				
Clio since 1998	1	8	1	8
Espace since 1996	1/2	8	1	8
Kangoo	1	8	1	8
Laguna	1	8		

Vehicle Type	Claw 4855-	Drive 4855-	Claw 4855-	Drive 4855-
<b>RENAULT</b>				
Laguna station wagon	1	8		
Megane since 1999	2	8		
Megane Limousine	2	8	1	8
Scenic	2	8		
Twingo	1	8		
<b>SAAB</b>				
9-3 up to 2003	2	8		
9-5	2	8		
<b>SEAT</b>				
Ibiza	1	8		
Cordoba	1	8		
Leon	1	8		
Toledo	1	8		
Arosa	1	8		
Alhambra	1	8		
<b>SKODA</b>				
Fabia	1	8		
Octavia	1	8		
Superb	1	8		
<b>VOLVO</b>				
740	3	8		
850	1	8		
940	3	8		
S 60	3	8		
C 70	1	8		
S 70	1	8		
V 70 up to 2000	1	8		
V 70 since 2001	3	8		
S 80	3	8		
XC 90	1	8		
<b>VOLKSWAGEN</b>				
Beetle	1	8		
Golf III	1	8	1	9
Golf IV	1	8	1	9
Golf V	1	8		
Lupo	1	8	1	9
Passat up to 2000	3	8	1	9
Passat since 2001	1	8	1	9
Polo up to 1999	3	8	3	8
Polo since 1999	1	8	1	9
Sharan up to 2000	2	8	3	9
Sharan since 2000	5	8	1	9
T 5 since 2003	2	8		
Touran	1	8		



Steering Wheel /Airbag

Pitman Arm Puller

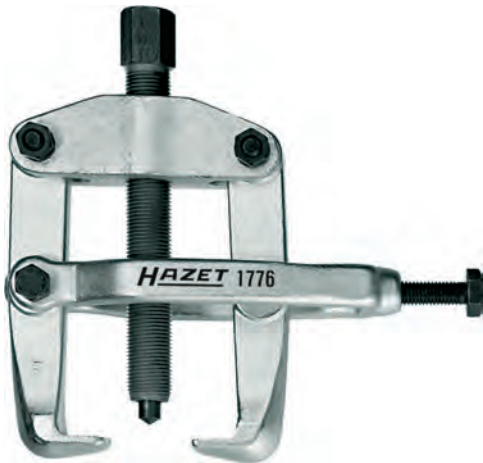

- For ball bearings, toothed wheels, pinions, **pitman arms** and similar
- The clamp clip is used for pressing the puller jaws on the parts to be extracted
- Surface: galvanized

**Made in Germany**

HAZET No.	s <i>b</i> mm	s <i>t</i> mm	Spindle	FAN-No. 4000896+
1776- 85	90	85	M 18 x 1.5 x 130	135943
1776-100	90	100	M 18 x 1.5 x 130	135950
1776-140	150	140	G ½" x 175	135967

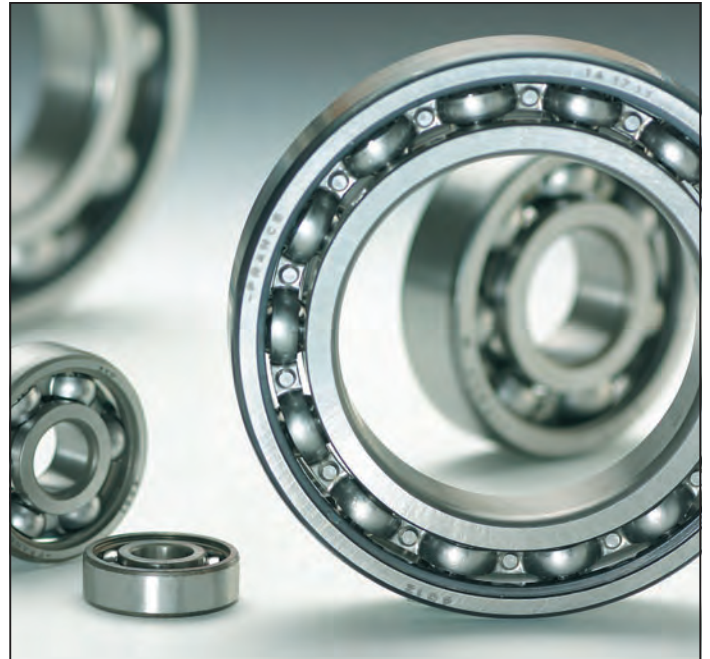

**HAZET**  
Ingenious Tools

**Seafarers put their trust in sea rescuers –  
sea rescuers put their trust in HAZET Quality Tools!**





# Borescope / Inspection



## Professional Borescopes



- Water-proof borescope probe; allows even short-time use in oil or gasoline
- Continuous focussing of the eyepiece provides sharp pictures (blue adjustment ring)
- The borescope probe does not get hot
- Specially coated achromatic optics for pictures without colour fringes
- On / off switch with continuous light regulation

- Bayonet catch allows fast adaptation of the battery handle to the basic appliance
- Eyepiece cup for spectacle wearers
- Included: Borescope, battery handle with 3 batteries (LR14), eyepiece cup

For expertises and the compilation of damage assessments at and in concealed areas as e.g.



### Industry:

- CNC machines, planetary gear, bearings and bushings, conducts, grooves, etc.
- Quality inspections in the surface area, welded joints, soldered joints, riveted joints, any kind of screwed connections, bore holes and each kind of threads



### Aviation:

- Sporting planes with motors, helicopters, chassis, motor parts: cylinders, valves / valve bottom, pistons / piston rings



### Passenger cars, commercial vehicles, motorcycles, boats:

- Parts of the motor like cylinder walls, pistons, valves, oil-pump, oil pan, gear, etc.
- Diagnostics of leaks in the motor, cooling circuit, visual inspection of the catalytic converter, car body, chassis, spars, shafts, wear of the axles, e.g. bearing collars, ball bearings, wear marks in the axle shaft, axle drive shafts, etc.

### Accessories: Mirror with thread (Side View Adapter)

The borescope's outer diameter does not increase when using the 90°/110° mirror (Side-View Adapter). Safe fastening ("unlosable")

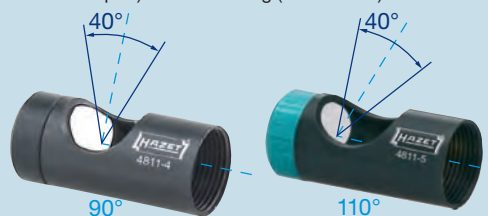

4.2 or 6 mm Ø

### Application fields:

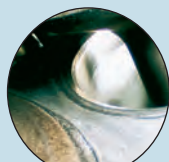

Valves



Hollow spaces (e.g. hollow shanks, sliding-roof, cavities)



Axle wear

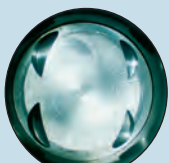

Cylinder wall, piston head



Gear damages and wear marks

### Technical Data

HAZET No.	4811-2/2	4811-1/2
Diameter	4.2 mm	6 mm
Work distance	5 mm to infinite	10 mm to infinite
Brightness at a distance of 16 mm	15,000 Lux	50,000 Lux
Count of glass fibres	<b>17,000</b>	<b>7,000</b>
Very small bending radius	30 mm	30 mm
Useful length borescope probe	720 mm	1000 mm
Aperture angle	40°	50°
Temperature range	-20° up to + 55° C	-20° up to + 55° C
Luminous source / bulb	3.5 V	3.5 V
Other	Reduced moment of rotation 360° torsion	

**Professional Borescope**

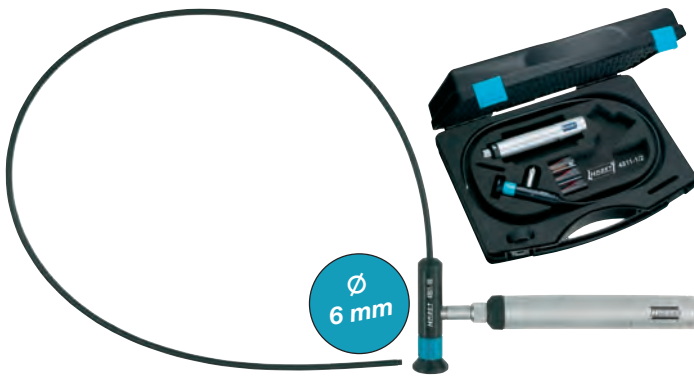

Made in Germany

HAZET No.	EAN-No. 4000896+
4811-1/2	109678



- 90° side-view adapter (mirror) for 4811-1/2**
- Extends the field of view to an aperture angle of 90°
  - The borescope's outside diameter (6 mm) remains the same
  - Tight screwing for safe fixation (unlosable)
  - Image angle 40°

4811-2	109685
--------	--------



- 110° side-view adapter (mirror) for 4811-1/2**
- Extends the field of view to an aperture angle of 110°
  - The borescope's outside diameter (6 mm) remains the same
  - Tight screwing for safe fixation (unlosable)
  - Image angle 40°

4811-3	115891
--------	--------

<b>Spare bulb 3.5 Volt for 4811-1/2 and 4811-2/2</b>	
4811-01	110377

**Professional Borescope**



Made in Germany

HAZET No.	EAN-No. 4000896+
4811-2/2	144136



- 90° side-view adapter (mirror) for 4811-2/2**
- Extends the field of view to an aperture angle of 90°
  - The borescope's outside diameter of 4.2 mm does not increase
  - Tight screwing for safe fixation (unlosable)
  - Image angle 40°

4811-4	144365
--------	--------

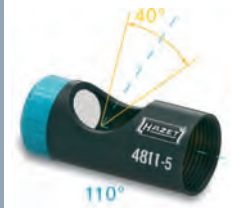

- 110° side-view adapter (mirror) for 4811-2/2**
- Extends the field of view to an aperture angle of 110°
  - The borescope's outside diameter of 4.2 mm does not increase
  - Tight screwing for safe fixation (unlosable)
  - Image angle 40°

4811-5	144372
--------	--------

<b>Spare bulb 3.5 Volt for 4811-1/2 and 4811-2/2</b>	
4811-01	110377

**LED-Scope Light**



Made in Germany

HAZET No.	EAN-No. 4000896+
<b>Brilliant white light in conjunction with HAZET Borescopes 4811-1/2 and 4811-2/2</b>	
• White LED (3 Watt), 5500 K to 6000 K colour temperature	
• Up to 110 000 Lux	
• Approx. 50,000 hours working life	
• Shock and impact resistant	
4811-8	154067

**Stethoscope**



- For the localization of damaged parts, e.g. axles, bearings and gearboxes
- Steel tip 180 mm
- Diaphragm with efficient transmission rate

Made in Germany

HAZET No.	l mm	EAN-No. 4000896+
2151	1080	013043
Ear tips for 2151		
2151-02/2	-	062287

