



HAZET *Assistant*

Made in Germany ... tried and tested since decades!

- ✓ High-quality materials as well as best fabrication techniques provide a long service life
- ✓ Big castors with a high capacity
- ✓ Suitable for HAZET plastic drawer inserts
- ✓ Sophisticated solutions for the mobile work place
- ✓ Quality that has been tried and tested 100,000 times in industry and craft
- ✓ For extreme charges



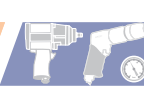

Tool Trolley



H 1099 x W 725 x D 398 mm

- Table board with integrated beech wood board, replaceable
- Intermediary containers suitable for HAZET plastic drawer inserts, 2 separation sheets included
- With additional sliding tray, to be integrated into the intermediary containers, e.g. for caliper gauges and small parts
- Spacious bottom container made of sheet steel
- Big castors to level out uneven ground surfaces
- Collapsible, lockable, padlock and 2 keys included
- Provided with wraparound protecting rubber strips
- Colour: HAZET-BLUE®

Made in Germany

HAZET No.	kg	EAN-No. 4000896+
-----------	----	------------------

- H 1099 x W 725 x D 398 mm
- With inflexible pillars

162 C	25.6	072279
-------	------	--------

Tool Trolley



H 1020 x W 850 x D 510 mm

H 1020 x W 850 x D 510 mm

- Extremely sturdy
- With shutter and wire mesh
- Lockable, padlock and 2 keys included
- 2 intermediary trays with 5 separation sheets each as well as 1 drawer for tool storage
- Loading capacity mobile: 400 kg
- Loading capacity of drawer for small parts: up to 5 kg
- Especially suitable for commercial vehicles
- Colour: HAZET-BLUE®

Made in Germany

HAZET No.	kg	EAN-No. 4000896+
-----------	----	------------------

172 HD	50.4	005819
--------	------	--------

Tool Trolley



H 1002 (647) x W 725 x D 398 mm

Like HAZET 162 C, but with collapsible swinging down pillars to reduce the height to a space saving minimum (647 mm)

Colour: HAZET-BLUE®
Made in Germany

HAZET No.	kg	EAN-No. 4000896+
-----------	----	------------------

166 C	27.6	072286
-------	------	--------

All tool trolleys without tools and accessories



Your commercial vehicle specialist!

Cabinet Trolley

Assistant® (E)



H 1100 x W 735 x D 560mm

H 1100 x W 735 x D 560 mm

- For biggest tool assortments
- With swing door, lockable in open position at 180°, with perforated sheet steel panel and lockable swivel castor
- 5 drawers with ball bearing rails, 100% sliding-out, with 2 separation sheets each for an individual drawer partition
- Further drawers can be retrofitted
- Lockable, padlock and 2 keys included
- Metal side pocket for drawings etc.
- Loading capacity mobile: 400 kg
- Loading capacity of 20 kg per drawer
- Surface: structure powder coated, HAZET-BLUE®

Made in Germany

HAZET No.	kg	EAN-No. 4000896+
174	93,5	005826
with 151-Piece Tool Assortment		
incl. tool hangers		
174/151	119,5	005871

Tool Assortment



For **automotive** and **industrial** companies, **151 pieces**, tool hangers included

Assistant



Contents:

- 428-10 12 13
- 450 N-6 x 7 8 x 9 10 x 11 12 x 13
14 x 15 16 x 17 18 x 19 20 x 22
21 x 23 24 x 27 25 x 28 30 x 32
- 600 N-6 7 8 9 10 11 12 13 14
15 16 17 18 19 20 21 22 23
24 25 26 27 28 30 32
- 630-6 x 7 8 x 9 10 x 11 12 x 13
14 x 15 16 x 17 18 x 19 20 x 22
21 x 23 24 x 26 25 x 28 30 x 32
- 730-3 6
- 746-1
- 748 b-3 4 5 6
- 757-10 12
- 760 N-1 2
- 803-20 35 55 100
- 803-PH 1 PH 2 PZ 1 PZ 2
- 824
- 850-4 5 6 7 8 9
10 11 12 13 14
- 8501-3 4 5 6 8
- 8503-0,6 x 3,5 0,8 x 4 1 x 5,5 1,2 x 8
- 8506-PH 1 PH 2 PH 3 PH 4
- 8507-PZ 1 PZ 2 PZ 3
- 863 P 865 866 U 867-2 868 869
- 900-10 11 12 13 14 15 16
17 18 19 20 21 22 23
24 26 27 28 30 32
- 915 916 SP 917-5 918-10 920
- 1803-22 1841 a-22
- 1952-35 1976
- 1980 N 1981
- 2100-02 025 03 04 05 06 08
- 2120-10
- 2122-10
- 2123-10
- 2140-2 5
- 2154-2 2160
- 6122-1 CT

HAZET No. 4000896+

HAZET No. 4000896+

0-174/151

000173



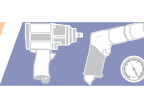

Assistant® 177



✓ Versatile

- Rectangular perforation of the side panels provides various fastening possibilities for accessories such as paper bin, can holder, cable drum etc.
- Strong plastic worktop resistant to solvent with 2 integrated storage wells
- Drawer partition system
- Innovative side panels, e.g. for HAZET tool hooks, article group 112

✓ Drawers

- 100% sliding-out
- 20 kg loading capacity per drawer, by default, the drawers are equipped with one separation sheet each
- Ball-bearing rails
- Suitable for HAZET-Safety-Insert-System and plastic drawer inserts
- Inner dimensions: w 527 x d 348
Flat drawer H 80 mm panel height
Big drawer H 165 mm panel height

✓ Safety

- Central locking, with cylinder lock and 2 keys
- Individual drawer locking prevents unwanted drawer opening
- Recessed side panels protect accessories from damage, being fastened within the trolley's outer dimensions

✓ Design

- Total loading capacity: 300 kg
- H 913 x W 778 x D 496 mm
- HAZET-BLUE®

✓ Made in Germany



177-7
(with 7 drawers)
H 913 x W 778 x D 496 mm

Tool Trolleys *Assistant*

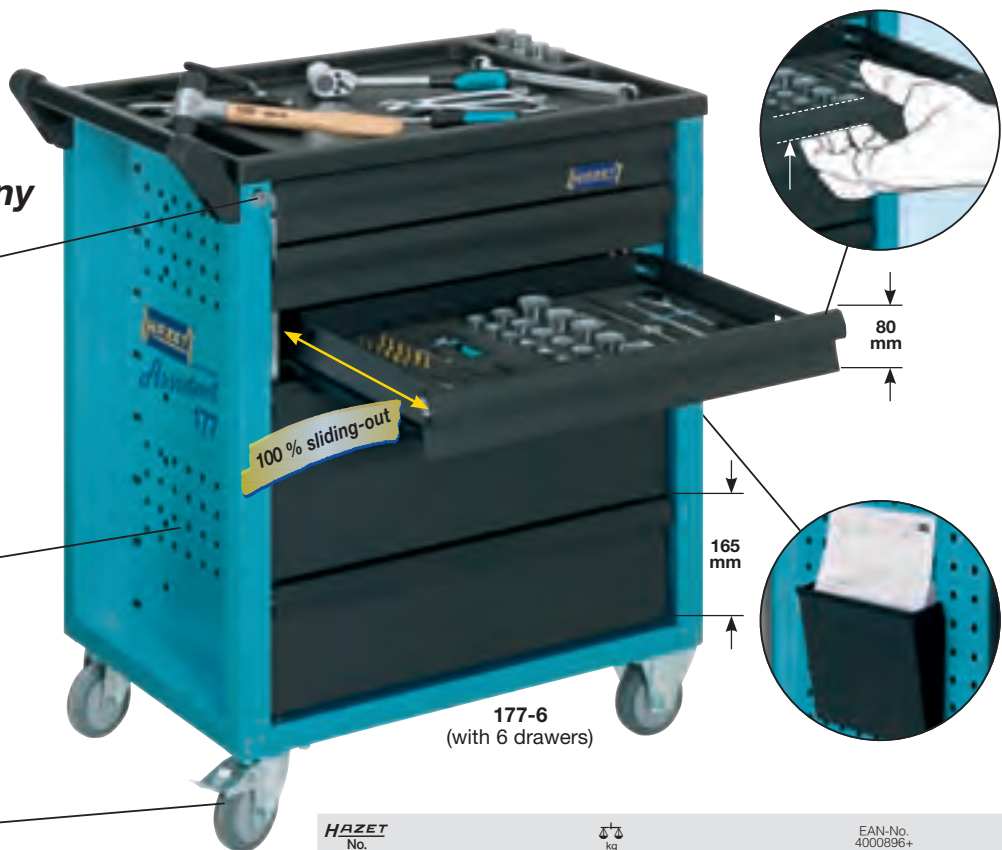

177-6
(with 6 drawers)

All tool trolleys without tools and accessories

HAZET No.	⚖️ kg	EAN-No. 4000896+
4 flat drawers and 2 big drawers 177-6	60	148578
6 flat drawers and 1 big drawer 177-7	62	148592



Assistant® 178



✓ Design

- With 6 or 7 drawers
- HAZET-BLUE®

✓ Two-level locking concept

- Central locking, lockable with cylinder lock and two folding keys
- Individual drawer locking prevents unwanted drawer opening

✓ Sturdy and technically well thought-out

- Ruggedly designed handle for highest tractive power, firmly attached to the trolley's corpus
- All four upper and lower edges are equipped with edge protection
- Plastic worktop resistant to solvent (oil, brake fluid, Skydrol) with compartments for small parts and label space (e.g. for personalisation details of the technician)
- Worktop border strip prevents parts from falling down

✓ Drawers

- Suitable for HAZET plastic drawer inserts and Safety-Insert-System
- All drawers on smooth-running ball-bearing rails are 100% sliding-out
- Inner dimensions of the drawers: W 527 mm x D 348 mm

✓ Various additional fastening possibilities

- Rectangular perforations on the side panels offer individual fastening possibilities, e.g. for tool hooks or other accessories like can holder, holder for paper reel, paper bin, etc.
- Recessed side panels protect accessories from damage, being fastened within the trolley's outer dimensions

✓ High-quality chassis

- Big and sturdy high-quality ball-bearing castors (∅ 125 mm) allow easy manoeuvrability, even with high dynamic load
- All castors equipped with thread guard (protection against dirt and threads)

✓ Extensive range of accessories from page 24 on

✓ Made in Germany

HAZET No.	∅ kg	EAN-No. 4000896+
3 flat drawers and 3 big drawers		
178-6	80.5	141296
5 flat drawers and 2 big drawers		
178-7	82	141241

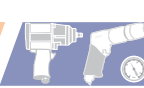

Assistant® 179



Well thought-out safety for your workshop ...

Three-level locking concept

- ✓ Central locking
- ✓ Individual drawer locking
- ✓ Mutual drawer locking for minimum tilting risk

25 kg
loading
capacity
per drawer

80 mm

100% sliding-out

... for safe is safe is safe!

165 mm

H 1040 x W 817 x D 502 mm



Same top equipment

as *Assistant*® 178 (see page 14)

- + With 6, 7 or 8 drawers and 1 separation sheet per drawer
- + **Three-level locking concept for more safety**
 - Central locking
 - Individual drawer locking
 - **Mutual drawer locking** for a minimum tilting risk (if necessary, the locking system can easily be deactivated)
- + All corners and edges are protected by **rubber edge protection**
- + Innovative and amply fastening panels
- + **Possibility of drawer labelling** (Label-sheet included)

- + All drawers are equipped with **ball-bearing telescopic rails** and 100% sliding-out
- + Inner dimensions of the drawers: w 527 mm x d 398 mm
- + Approx. **13% higher drawer capacity** than the *Assistant*® 169 N and 178
- + **Extensive range of accessories from page 24 on**
- ✓ **Made in Germany**

HAZET No.	± kg	EAN-No. 4000896+
3 flat drawers and 3 big drawers 179-6	88	141265
5 flat drawers and 2 big drawers 179-7	90	140794
7 flat drawers and 1 big drawer 179-8	92	141272

Assistent® 179



Assistent® 179-8-RAL7021/289

Assistent
2-component Safety-Insert-System



Audi recommends
HAZET Service Tool
Trolley and Assortment



163-119/23

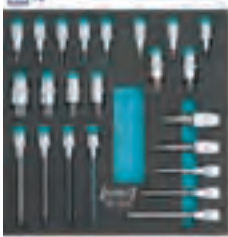

(2/3)

163-53/75



(3/3)

163-120/24



(3/3)

- 163-130 L
- 163-522 x 50 (6x)
- 180-38
- 426-6 7 8
- 450 N-24 x 27 30 x 32
- 600 N-27 30 32
- 612-10 x 11
- 630-24 x 27 30 x 32
- 650-20 824



163-121/4



(1/3)

163-131/8



(3/3)

163-30/25



(3/3)

163-118/57



(3/3)

- 803 Lg-T 15 T 20 T 25 T 30
- 828-T 45
- 880 G/10 H
- 880 T2/10 H
- 900 S2-32 34 36
- 918-23
- 1015/2 2130
- 2211-4 5 6 8 10
- 6420 b 6420 c

163-97/6



(1/3)

163-122/3



(1/3)

163-95/8

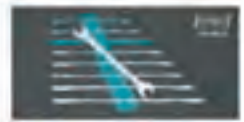

(1/3)

163-124/4



(1/3)

Tool Trolley 179-8, black grey (RAL 7021)
Complete with **289-pc.** tool assortment
in 2-component soft foam inserts "Safety-Insert-System"
Detailed information on contents of inserts you will
find from page 34 (see article no. of the respective insert)

HAZET
No.

179-8-RAL 7021/289

EAN-No.
4000896+

154623

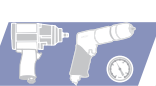

Assistant® 179-1



Tool Trolley *Assistant*® 179-1 for Surface Finishing Developed for the demands of paint shops

- ✓ Painting
- ✓ Processing
- ✓ Smart repair
- ✓ **Made in Germany**

Support for small parts 179-25

Optional!

Vertical Tool Panel 179-26

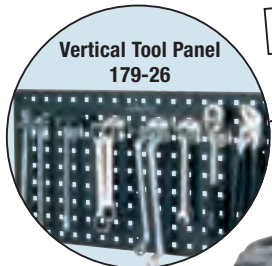

Holder for paper reel 180-34

Optional!

Paper Bin 180-33

Optional!



All tool trolleys without tools and accessories

HAZET
 No.

179-1

kg

78

EAN-No.
 4000896+

165018



Assistant® 179 BIG-1



Tool Trolleys *Assistant*

The TOP-Assistent!

- ✓ With 13 drawers (11 flat and 2 big drawers) and 1 separation sheet each
- ✓ Three-level locking system for more security
- ✓ Central locking for all drawers, lockable with cylinder lock and two folding keys
- ✓ Individual drawer locking prevents unwanted drawer opening
- ✓ Mutual drawer locking for a minimum tilting risk
- ✓ Hinged lid offering plenty of storage space for additional tools

- ✓ Gas pressure springs for optimal cover guiding, no uncontrolled lowering
- ✓ Storage compartment with front door, lockable, 2 folding keys included
- ✓ All locks with simultaneous locking
- ✓ Sturdy and technically well thought-out
- ✓ All corners are protected by rubber edge protection
- ✓ Pull-out shelf in the front
- ✓ Innovative side panels, e.g. for HAZET tool hooks, article group 112
- ✓ High-quality ball-bearing castors, 125 mm Ø
- ✓ HAZET-BLUE®

Drawers

- ✓ Possibility of drawer labelling (label-sheet inside)
- ✓ High loading capacity: 25 kg per drawer
- ✓ All drawers are equipped with ball-bearing telescopic slides and 100% sliding-out
- ✓ Inner dimensions of the drawers:
W 527 mm x D 398 mm
- ✓ Flat drawer: 80 mm high
- ✓ High drawer: 165 mm high
- ✓ **Made in Germany**

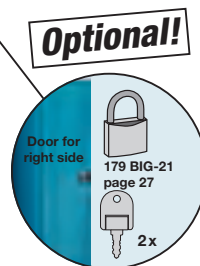
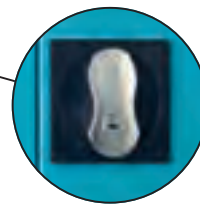
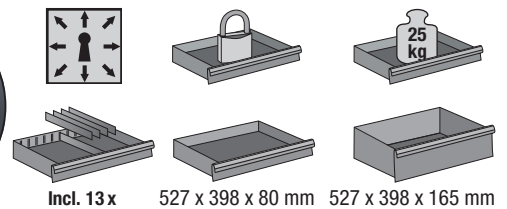
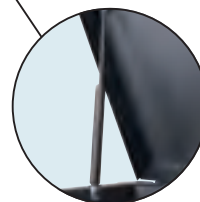

Ø 125 mm

HAZET No.	kg	EAN-No. 4000896+
179 BIG-1	180	159321

All tool trolleys without tools and accessories

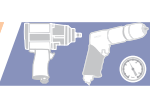

Assistant® 179 XL

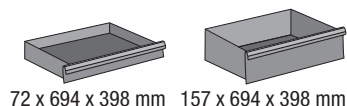
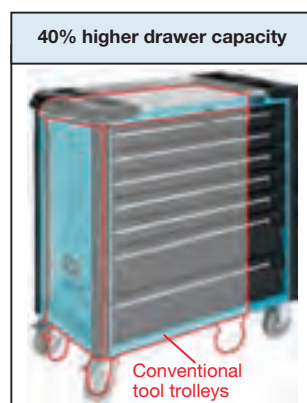

H 1027 x W 980 x D 503 mm

✓ Various additional fastening possibilities

- Rectangular perforations on the side panels offer individual fastening possibilities, e.g. for tool hooks or other accessories like can holder, holder for paper reel, paper bin, etc.
- Recessed side panels protect accessories from damage, being fastened within the trolley's outer dimensions

✓ High-quality chassis

- Big and **sturdy high-quality castors with precision ball bearing** (∅ 125 mm) and swivel bearing with double ball race allow easy manoeuvrability, even with high dynamic load
- **2 swivel castors with double stop function**: fixed castor prevents inadvertent rolling of the trolley, fixed swivel bearing prevents the castors from swivelling, e.g. on an inclined surface
- Elastic non-marking rubber tyre offer a smooth movement

✓ Extensive range of accessories from page 24 on

✓ Made in Germany

✓ Design:

- With 6, 7 or 8 drawers
- HAZET-BLUE®

✓ Two-level locking concept

- **Central locking**, lockable with cylinder lock and two folding keys
- **Mutual drawer locking** for a minimum tilting risk

✓ Sturdy and technically well thought-out

- **Stainless steel worktop for excessive use**
- **Static loading capacity: 1,000 kg**
- Ruggedly designed handle for highest tractive power, firmly attached to the trolley's corpus
- All corners are protected by rubber edge protection
- Plastic worktop compartments resistant to solvent (oil, brake fluid, Skydrol) offer storage place for small parts
- Worktop border strip prevents parts from falling down

✓ Drawers

- **40% higher drawer capacity** than conventional tool trolleys
- High loading capacity: **40 kg per drawer**
- All drawers are equipped with **ball-bearing, self-closing telescopic slides and 100% sliding-out, with integrated soft-close**
- Separable drawer slide system for increased flexibility
- Suitable for HAZET plastic drawer inserts and Safety-Insert-System
- Possibility of drawer labelling
- Inner dimensions of drawers: W 694 mm x D 398 mm

HAZET No.	∆ kg	EAN-No. 4000896+
3 flat drawers and 3 big drawers 179 XL-6	95	177417
5 flat drawers and 2 big drawers 179 XL-7	101	177400
7 flat drawers and 1 big drawer 179 XL-8	106.5	177424

Work Benches / Tool Cabinets



Mobile Work Bench



H 934 x W 1040 x D 520 mm

Mobile Work Bench



H 970 x W 1150 x D 600 mm

Sturdy and versatile

- Drawer partition system
- One side with fastening panel, e.g. for HAZET tool hooks of the article group 112, can holder, etc.
- Birch multilayer worktop (30 mm thick), surface oiled according to environmental regulations
- High-quality ball-bearing castors with thread guard and high loading capacity
- Various fastening possibilities for accessories

Safety – Two-level locking concept

- Central locking, lockable with cylinder lock and two keys
- Individual drawer locking prevents unwanted drawer opening

Drawers

- 100% sliding-out
- 20 kg loading capacity per drawer, by default, the drawers are equipped with one separation sheet each
- Roller guides
- Suitable for HAZET 2-component soft foam inserts "Safety-Insert-System" and plastic drawer inserts
- Inner dimensions: w 527 x d 348 mm
 - Flat drawer H 80 mm panel height
 - Big drawer H 165 mm panel height

Boards in the side panel

- Loading capacity top: 15 kg/bottom: 35 kg
- Variable boards

Total loading capacity

- 500 kg (dynamic), 700 kg (static = upright, on even surfaces)

Optional accessory

- 177 W-21: Door for right side of work bench, lockable (2 keys included), weight: 6 kg (see page 26)

Made in Germany

HAZET No.	kg	EAN-No. 4000896+
Design With 6 drawers (4 flat and 2 big drawers as well as 2 boards in the side panel)		
177 W-6	85	154630
Design With 7 drawers (6 flat drawers, 1 big drawer as well as 2 boards in the side panel)		
177 W-7	85	155644

Top equipment

- With 5 or 7 drawers and 1 separation sheet each

Three-level locking system for more security

- Central locking, lockable with cylinder lock and two folding keys
- Individual drawer locking prevents unwanted drawer opening
- Mutual drawer locking for a minimum tilting risk (if necessary, the locking system can easily be deactivated)

Sturdy and technically well thought-out

- All corners are protected by rubber edge protection
- Birch multilayer worktop (30 mm thick), surface oiled according to environmental regulations
- Innovative side panels, e.g. for HAZET tool hooks, article group 112

Drawers

- Possibility of drawer labelling (label-sheet inside)
- High loading capacity: 25 kg per drawer
- All drawers are equipped with ball-bearing telescopic slides and 100% sliding-out
- Inner dimensions of the drawers: W 527 x D 398 mm
 - Flat drawer 80 mm panel height,
 - big drawer 165 mm panel height

Total loading capacity

- 750 kg (dynamic), 1000 kg (static = upright, on even ground)
- High-quality ball-bearing castors

Optional accessory

- 179 W-21: Door for right side of work bench, lockable (with 2 folding keys) (see page 27)

Made in Germany

HAZET No.	kg	EAN-No. 4000896+
5 drawers (3 x big drawers and 2 x flat drawers with a loading capacity of 25 kg each) and 2 boards in the side panel (top: 15 kg/bottom: 35 kg)		
179 W-5	110	145348
7 drawers (1 x big drawer and 6 x flat drawers with a loading capacity of 25 kg each) and 2 boards in the side panel (top: 15 kg/bottom: 35 kg)		
179 W-7	112	145331





Work Bench



H 845 x W 2000 x D 760 mm

Made in Germany

HAZET No.	kg	EAN-No. 4000896+
130-1	76.5	003358

Tool Cabinet with Assortment

Contents:

603-6 7 8 9 10 11 12 13 14 15 16 17 18 19 21 22 24
 630-6 x 7 8 x 9 10 x 11 12 x 13 14 x 15 16 x 17
 18 x 19 20 x 22 21 x 23 24 x 27 30 x 32
 730-3 6 746-1 748 b-3 4 5 6 760 N-1 2 3
 802-40 55 80 100 802-PH 1 PH 2 PZ 1 PZ 2 824
 850-4 4.5 5 5.5 6 7 8 9 10 11
 863 P 867-2 868 869
 900-10 11 12 13 14 15 16 17 18 19
 20 21 22 23 24 26 27 28 30 32
 915 916 SP 917-5 918-10 920 985-5 6 8 10
 1802-11 1841 a-22 1845 A-19 1845 C-19 1952-35 1980 N 1981
 2100-02 025 03 04 05 06 08
 2115-T 8 T 10 T 15 T 20 T 25 T 30 T 40
 2120-8 2122-8 2123-8 2140-5 2154

HAZET No.	kg	EAN-No. 4000896+
111/116	46.4	003105

Tool Cabinet



H 1000 x W 640 x D 250 mm

- With blind, lockable, including padlock with 2 keys
- Fixing device included
- Empty, for individual tool assortment

Made in Germany

HAZET No.	kg	EAN-No. 4000896+
111 L	25	003266

Tool Hanger



For 116-pc. tool assortment 0-111/116

Contents:

111-03 L 111-03 R 111-04
 111-05 111-06 (15x) 111-10 (2x)
 111-15 111-17 (2x) 111-22 (4x) 111-28 (3x)
 603/17 HL
 2025 X 2025 X-6/4 2025-E 04 (25x)

HAZET No.	EAN-No. 4000896+
111/116 HL	003112

Tool Assortment



116 pieces,
contents see 111/116,
without tool cabinet

HAZET No.	EAN-No. 4000896+
0-111/116	000098

Tool Cabinet with Assortment



H 1000 x W 640 x D 250 mm

With 116 piece tool assortment, suspension plan, tool hangers and soft foam inserts for socket sets

Components and Spare Parts see pages 279 to 285



Tool Hanger



Made in Germany

HAZET No.	EAN-No. 4000896+
Hanger, for e.g. 630-6 x 7 up to -20 x 22, to be used with 111-03 L	
111-03 R	002849
Hanger, to be used with 111-03 R	
111-03 L	002832
Hanger, for 4 $\frac{1}{8}$ sockets	
111-04	002856
Hanger, for e.g. Chisels 730-3 up to -6, Center Punch 746-1, Drift Pins 748	
111-05	002863



Made in Germany

HAZET No.	EAN-No. 4000896+
Hook, for e.g. 279, 760 N, 2100/7 R etc.	
111-06	002870
Hanger, for e.g. Combination Wrenches 603 or Hammers 2140 etc.	
111-10	002917
Hanger, for e.g. Flexible Handles 914 etc.	
111-11	002924
Hanger, for e.g. Four-Way Rim Wrenches 715 (use 4 pieces) or Pry Bars 2164 (use 2 pieces)	
111-12	002931
Hanger, for e.g. Tape Measures	
111-15	002962



Made in Germany

HAZET No.	EAN-No. 4000896+
Hanger, for e.g. Double Box End Wrenches 630-21 x 23 up to 30 x 32 to be used in pairs	
111-17	002986
Tool hook \varnothing 3 mm, / 80 mm	
111-20	003013
Tool hook \varnothing 6 mm, / 75 mm	
111-21	003020
Tool hook	
111-22	003037
Tapping screw	
111-28	003099

Tool Hanger

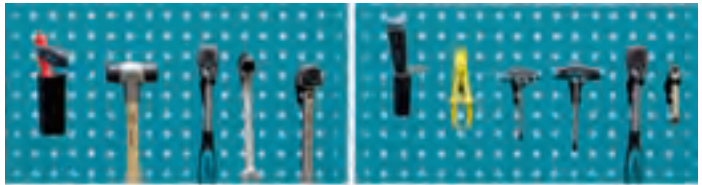

Suitable for perforated panels with square perforation (e.g. rear and side panels of Tool Trolleys 176, 177, 178, 179, 179 BIG-1, 179 XL, 180, 180 K-4 as well as work benches 177 W and 179 W)

HAZET No.	EAN-No. 4000896+
Double hook, 30 mm long, e.g. for tools with T-handle	
112-230	103898
Double hook, 60 mm long, e.g. for tools with T-handle	
112-260	103881
Hook, 25 mm long, e.g. for tools with hanging hole	
112-325	103874
Hook, 50 mm long, e.g. for tools with hanging hole	
112-350	103867
Double hook, wide, 40 mm long, e.g. for Torque Wrenches	
112-440	103850
Double hook, wide, 50 mm long, e.g. for Torque Wrenches	
112-450	103843
Clip, \varnothing 12 mm, e.g. for Reversible Ratchet 863 F, P, S as well as Reversible Ratchet for Bits 863 B GL, BKC and BK	
112-612	103836
Clip, \varnothing 18 mm, e.g. for Reversible Ratchets 8816 F, P or S as well as 916 K	
112-618	103720
Clip, \varnothing 24 mm, e.g. for Reversible Ratchets 916 F, SP or S as well as 916-1	
112-624	103713
Plastic cup, \varnothing 30 mm, 80 mm high, e.g. for pens, drift pins etc.	
112-830	103706
Plastic cup, \varnothing 50 mm, 114 mm high, e.g. for Marking Tool 2150-1 or similar	
112-850	103690
Tool Hook Set 11 pieces, 1 each	
112-230 260 325 350 440 450 612 618 624 830 850	
112/11	104239



Tool Hanger



Universal Clamping Rails

- Handy storage for any kind of tools
- Rail with 2 long holes allowing variable fixation even on perforated sheet metal displays
- Two flexible clamps embrace each tool without damaging it
- Flexible clamps made of oil resisting and antifreezing plastic, **flexible, durable**
- Rail made of anodized light metal

HAZET No.	l mm	EAN-No. 4000896+
2025 X	440	010301
2025 X-1	150	010424

Tool Hangers and Guiding Rails

HAZET No.	EAN-No. 4000896+
Guiding Rail, complete, with 3 tool hangers 150 mm long for wall fixation	
2025 X-6/4	058259
Tool Hanger self locking, to be inserted into guide rails 2025 X-5 and 2025 X-6	
2025 X-06	010394
Guiding Rail for above mentioned tool hanger	
2025 X-5	010479
Guiding Rail for above mentioned tool hanger	
2025 X-6	010486

Sales Display Chest



For small parts,
24 drawers, empty,
plastic, colour RAL 5013
290 x 305 x 180

HAZET No.	EAN-No. 4000896+
2026-5 VS L	100927
10 sheets for transverse drawer partition	
2026-01/10	100934

Tool Hangers and Guiding Rails

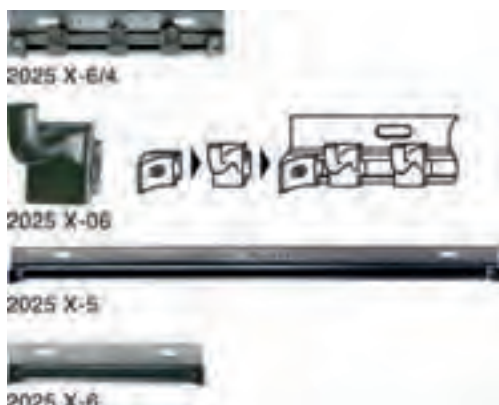

HAZET obtained a large number of patent rights, utility patent and design patent rights!



HAZET is famous for its innovative development activity. This led to the grant of numerous patent rights both in Germany and Europe.

HAZET obtained a large number of patent rights, utility patent and design patent rights, which are protected and constantly extended in the context of a consistent policy.



HAZET No.	Designation	Tool Trolley <i>Assistant</i> Type:																	
		162 N 166 N	162 C 166 C	168	169 N	171	172 HD	173	174	176	177	177 W	178	179	179 BIG	179 XL	179 W	180	180 K-4
112/11	Tool Hanger Set								X	X	X	X	X	X	X	X	X	X	X
161 T-85/5	Set of separation sheets: 2 raster strips (right and left) and 3 separation sheets 85 mm				X				X	X									
161 T-130/5	Set of separation sheets: 2 raster strips (right and left) and 3 separation sheets 130 mm				X				X	X									
161 T-172/5	Set of separation sheets: 2 raster strips (right and left) and 3 separation sheets 172 mm				X				X	X									
161 T-345/5	Set of separation sheets: 2 raster strips (right and left) and 3 separation sheets 345 mm				X ⁶⁾				X ⁶⁾	X ⁶⁾									
161 T-347x60/5	5 separation sheets 60 x 347 mm				X ⁷⁾				X ⁷⁾	X ⁷⁾	X	X	X						
161 T-347x120/5	5 separation sheets 120 x 347 mm				X ⁷⁾				X ⁷⁾	X ⁷⁾	X	X	X						
161 T-522/5	Set of separation sheets: 2 raster strips (right and left) and 3 separation sheets 522 mm				X ⁶⁾				X ⁶⁾	X ⁶⁾									
161-1	Anti-Slipping Mat 348 x 523 mm				X	X			X	X	X	X	X						
161-3 D	Cable drum with holding device (10 m)				X ¹⁾				X ²⁾	X ¹⁾	X	X	X	X	X	X	X	X	X
161-8	Window pane holder with rubber pads 65 mm Ø	X ⁴⁾	X ⁴⁾			X ⁴⁾	X ⁴⁾			X ⁴⁾			X ⁴⁾	X ⁴⁾		X ⁴⁾		X ⁴⁾	X ⁴⁾
161-9	Window pane holder with rubber pads, swivelling 120 mm Ø	X ⁴⁾	X ⁴⁾			X ⁴⁾	X ⁴⁾			X ⁴⁾			X ⁴⁾	X ⁴⁾		X ⁴⁾		X ⁴⁾	X ⁴⁾
162 C-5	Container for small parts				X														
162 C-6/5	5 separation sheets for intermediary tray				X														
170-3	Paper bin, fixing kit included					X ¹⁾			X ²⁾	X ¹⁾	X								
170-4	Holder for Paper Reel (without paper reel)					X ¹⁾			X ²⁾	X ¹⁾	X								
172-5/5	5 separation sheets						X												
173-21	Plastic insert for plastic worktop								X										
173-23	Distance plate (wood) for machinists vice 2175 N								X		X		X	X					
173-31/5	5 separation sheets 60 x 397 mm								X					X	X	X	X	X	X
173-32/5	5 separation sheets 120 x 397 mm								X					X	X	X	X	X	
173-35	Can holder (for 3 aerosols)					X ¹⁾			X ²⁾	X ¹⁾	X								
173-36/5	5 small plastic drawer inserts for drawers								X					X	X	X	X	X	X
173-38	Anti-slipping mat 395 x 690 mm								X							X			
173-40/10	10 magnetic labels with paper insert (l 120 x h 25 mm)				X	X			X	X									
173-6	Can holder with variable partition					X ¹⁾			X ²⁾	X ¹⁾	X								
177 W-21	Door for right side												X						
179 BIG-21	Lateral door, lockable														X				
179 W-21	Door for right side																	X	
179 W-22	Drawer for Storage Compartment																	X	
179 W-23	Supplementary Storage Shelf																	X	
179 XL-21	Lateral door, lockable																	X	
179 XL-22	Wooden board																	X	
179 XL-26	Vertical tool panel, assortment of hangers included																	X	
179-21	Door, lockable (right side on 179)													X					
179-25	Support for small parts, attachable, assortment of boxes included													X	X				
179-26	Vertical tool panel, assortment of hangers included													X	X				
179-28	Tool bin, to be hooked into side panel													X	X	X	X	X	X
179-35	Can holder (for 3 aerosols)													X	X	X	X	X	X
180 N-22	Wooden board since date of construction 05/2010																		X
180-21	Lateral door, lockable																		X
180-22	Wooden board until date of construction 05/2010																		X
180-24	Document Holder													X	X	X	X	X	X
180-25	Support for small parts, attachable, assortment of boxes included																		X
180-26	Vertical tool panel, assortment of hangers included																		X
180-27	Work tray, swivelling													X					X
180-28	Tool bin, to be hooked into side or rear panel																		X
180-30/13	Set of drawer partitions																		X
180-31/5	Set of separation sheets (5 separation sheets for transversal partition 532 x 60 mm)																		X
180-33	Paper bin, fixing kit included													X	X	X	X	X	X
180-34	Holder for Paper Reel (without paper reel)													X	X	X	X	X	X
180-35	Can holder (for 4 aerosols)																		X
180-38	Anti-slipping mat 394 x 529 mm													X	X			X	X
190-20-1	Cockpit retaining plate, right, 178, 179													X	X				
190-20-2	Cockpit retaining plate, rear 178,179													X	X				
190-20-3	Cockpit retaining plate, right, 180																		X
2175 N	Machinist's Vice							X ³⁾	X ⁵⁾		X ⁵⁾	X ³⁾		X ⁵⁾	X ⁵⁾			X	X ³⁾

1) Only since date of construction 06/2002 – fixation of one accessory only
 2) Fixation of maximum two accessories
 3) Wooden liner 2175 N-11 necessary
 4) To be used in pairs
 5) In conjunction with 173-23
 6) Until model year 2000
 7) Since model year 2001

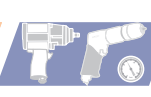

Drawer Partition System

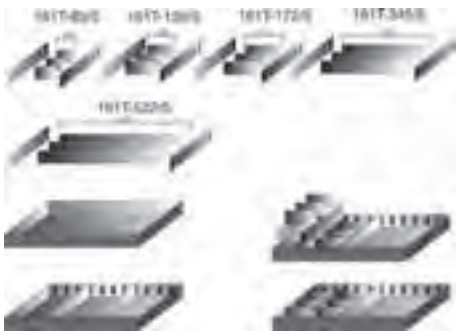

Raster strips and separation sheets for the arbitrary drawer partition of Assistant 169 N, 170, 174 and 176-1

Made in Germany

HAZET No.	EAN-No. 4000896+
Set of separation sheets consisting of 2 raster strips (right and left) and 3 separation sheets L 85 mm	
161 T-85/5	120697
Set of separation sheets consisting of 2 raster strips (right and left) and 3 separation sheets L 130 mm	
161 T-130/5	120703
Set of separation sheets consisting of 2 raster strips (right and left) and 3 separation sheets L 172 mm	
161 T-172/5	120710
Set of separation sheets consisting of 2 raster strips (right and left) and 3 separation sheets L 345 mm	
161 T-345/5	120727
Set of separation sheets consisting of 2 raster strips (right and left) and 3 separation sheets L 522 mm	
161 T-522/5	120734
Set of separation sheets consisting of 5 separation sheets 347 mm long, 60 mm high	
161 T-347 x 60/5	120758
Set of separation sheets consisting of 5 separation sheets 347 mm long, 120 mm high	
161 T-347 x 120/5	120765

Anti-Slipping Mat



For anti-slipping tool storage in the tool trolley drawers

HAZET No.	EAN-No. 4000896+
Anti Slipping Mat 694 x 395 mm, suitable for Tool Trolley Assistant 173 and 179 XL	
173-38	089789
Anti Slipping Mat 529 x 394 mm, suitable for Tool Trolley Assistant 179, 179 W, 179 BIG-1, 180 and 180 K-4	
180-38	120819
Anti Slipping Mat 348 x 523 mm suitable for Tool Trolley Assistant 168, 169 N, 174, 176, 177, 177 W and 178	
161-1	058884

Cable Drum



Made in Germany

HAZET No.	EAN-No. 4000896+
Cable Drum For Tool Trolleys Assistant 173, 174, 176, 177, 177 W, 178, 179, 179 BIG-1, 179 XL, 179 W and 180 as well as 169 N since 2004 With holding device, with 10 m cable – Export versions available –	
161-3 D	048878

Window Pane Holder



Window Pane Holder with mechanical suction swivel pads 120 mm Ø, for Tool Trolleys Assistant 162 C, 162 N, 166 C, 166 N, 171, 172 HD, 176, 178, 179, 179 XL, 180 and 180 K-4
Price apiece/ to be used in pairs

HAZET No.	EAN-No. 4000896+
161-9	004867

Window Pane Holder



Window Pane Holder with rubber pads 65 mm Ø, for Tool Trolleys Assistant 162 C, 162 N, 166 C, 166 N, 171, 172 HD, 176, 178, 179, 179 XL, 180 and 180 K-4
Price apiece/ to be used in pairs

HAZET No.	EAN-No. 4000896+
161-8	004843

Tool Trolley Accessories

HAZET No.	EAN-No. 4000896+
Container for small parts for Tool Trolleys Assistant 162 C and 166 C	
162 C-5	078189
Separation sheet for intermediary tray for Tool Trolleys Assistant 162 C and 166 C	
162 C-6	079810
Set of separation sheets consisting of 5 separation sheets for Tool Trolleys Assistant 162 C and 166 C	
162 C-6/5	120772

Tool Trolley Accessories

HAZET No.	EAN-No. 4000896+
-----------	------------------



Paper Bin for Tool Trolleys Assistant 169 N, 170, 173, 174 (since 06/2002), 176 incl. fixing kit

170-3	060054
--------------	--------



Holder for Paper Reel (without paper reel) for Tool Trolleys Assistant 169 N, 170, 173, 174 (since 06/2002), 176 incl. fixing kit For paper reels with a Ø up to 350 mm and 280 mm wide

170-4	060061
--------------	--------

Set of separation sheets consisting of 5 separation sheets for Tool Trolley Assistant 172 HD

172-5/5	120789
----------------	--------



Tool Bin Variable subdivision with three separation sheets For Tool Trolleys Assistant 169 N since 06/2002, 173, 174, 176-1 H 131 x W 320 x D 120 mm

173-6	099276
--------------	--------



5 Separation sheets (60 x 397 mm) for flat drawer on Tool Trolleys Assistant 173, 179, 179 BIG-1, 179 XL, 179 W, 180, 180 K-4

173-31/5	090150
-----------------	--------



5 separation sheets (120 x 397 mm) for big drawer on Tool Trolleys Assistant 173, 179, 179 BIG, 179 XL, 179 W and 180

173-32/5	120796
-----------------	--------

Continuation see next page ▶



Tool Trolley Accessories

HAZET No. EAN-No. 4000896+



Can holder e.g. for 3 aerosols for Tool Trolleys Assistant 173, 174, 176-1 and 169 N since 06/2002, incl. fixing kit

173-35 090235



5 small plastic drawer inserts for drawers on Tool Trolleys Assistant 173, 179, 179 BIG, 179 XL, 179 W, 180 and 180 K-4 H 40 x W 170 x D 50 mm

173-36/5 090167



Anti Slipping Mat 694 x 395 mm, suitable for Tool Trolley Assistant 173 and 179 XL

173-38 089789



10 Magnetic labels with paper insert for Tool Trolleys Assistant 168, 169 N, 173, 174 120 x 25 mm

173-40/10 090051



Door for right side of work bench on Tool Trolley Assistant 177 W, lockable

177 W-21 154739

Tool Trolley Accessories

HAZET No. EAN-No. 4000896+



Door, lockable, 2 keys included, for right side panel on Tool Trolley Assistant 179 80 mm clear depth, 785 mm usable height

179-21 146246



Support for small parts

- Attachable to Tool Trolley Assistant 178 and 179
- Magazine for screws and other small parts included

179-25 164899



Vertical Tool Panel

- Attachable to Tool Trolley Assistant 178 and 179
- For the fixation of additional tools
- Assortment of 8 hangers, included: 112-260, 325, 350, 450, 612, 618, 624, 830

179-26 164967



Tool bin, for side panel of Tool Trolleys Assistant 177, 177 W, 178, 179, 179 BIG-1, 179 XL, 179 W, 180 and 180 K-4

179-28 141234

Tool Trolley Accessories

HAZET No. EAN-No. 4000896+



Can holder for 3 cans for Tool Trolley Assistant 177, 177 W, 178, 179, 179 BIG-1, 179 XL, 180, 180 K-4 as well as inside the door 179-21

179-35 141074



Lateral door, lockable

For right side panel on Tool Trolley Assistant 179 XL

- 2 keys included
- Approx. 80 mm clear depth, approx. 770 mm usable height

179 XL-21 177547



Wooden Worktop

Fits into the stainless steel worktop of the Tool Trolley Assistant 179 XL

179 XL-22 177974



Vertical Tool Panel attachable to Tool Trolley Assistant 179 XL, for the fixation of additional tools assortment of hangers included

179 XL-26 178117

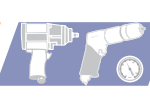

Tool Trolley Accessories

HAZET No. EAN-No. 4000896+



Door for right side of work bench on Tool Trolley Assistant 179 W, lockable
179 W-21 145485



Supplementary drawer for Mobile Work Bench 179 W. Suitable for the right storage compartment. Inner dimensions: H 79 x W 284 x D 398 mm
179 W-22 146567



Supplementary Storage Shelf for Mobile Work Bench 179 W Suitable for the right storage compartment. Loading capacity: 15 kg
179 W-23 150311



Lateral door, lockable for Tool Trolley Assistant 179 BIG-1 incl. 2 keys
179 BIG-21 159901

Tool Trolley Accessories

HAZET No. EAN-No. 4000896+



Document Holder for working documents for Tool Trolleys Assistant 177, 177 W, 178, 179, 179 BIG-1, 179 XL, 179 W, 180 and 180 K-4
180-24 110827



Work Tray, attachable to Tool Trolley Assistant 179 and 180, swivelling, as additional writing board, place for documents, laptop etc.
180-27 110858



Paper Bin
• Fixing kit included
• To be hooked into the square perforation, no additional adapter necessary for Tool Trolleys Assistant 177, 178, 179, 179 BIG-1, 179 XL, 179 W and 180
180-33 120833

Tool Trolley Accessories

HAZET No. EAN-No. 4000896+



Holder for paper reel
• Fixing kit included (without paper reel)
• For Tool Trolleys Assistant 177, 178, 179, 179 BIG-1, 179 XL, 179 W, 180 and 180 K-4
For paper reels with a Ø up to 350 mm and 280 mm wide
180-34 120840



Can holder
• For 4 cans
• Fixing kit for Tool Trolley Assistant 179 W and 180 included
• To be hooked into the square perforation, no additional adapter necessary
180-35 120826



Anti Slipping Mat 529 x 394 mm, suitable for Tool Trolley Assistant 179, 179 W, 179 BIG-1, 180 and 180 K-4
180-38 120819



Machinist's Vice
2175 N 013685
Distance plate (wood) for machinist's vice 2175 N for fixing the vice on work benches or tool trolleys 172 HD, 177, 179 W, 180, 180 K-4 incl. fixing kit
2175 N-11 013692
Distance plate (wood) for machinist's vice 2175 N for fixing the vice on tool trolleys Assistant 173-1, 176-1, 178, 179 fixing kit included
173-23 090228



Tool Modules



HAZET-Plastic Drawer Inserts

- ✓ Robust plastic drawer inserts with standardized dimensions provide a clear arrangement of tools in your HAZET Tool Trolley Assistant.
- ✓ Suitable for HAZET-Assistent[®] 162 C, 166 C, 168, 169 N, 173, 174, 177, 177 W, 178, 179, 179 W, 179 BIG-1, 179 XL, 180



162 C / 166 C, 168, 169 N, 174, 177, 177 W, 178

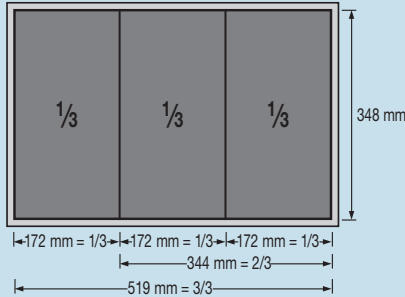

179, 179 W, 179 BIG-1, 180

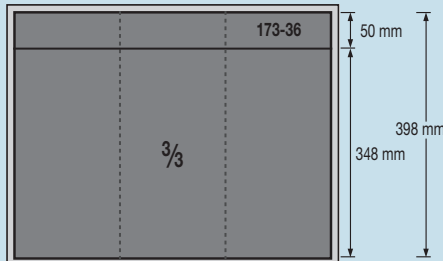

173, 179 XL

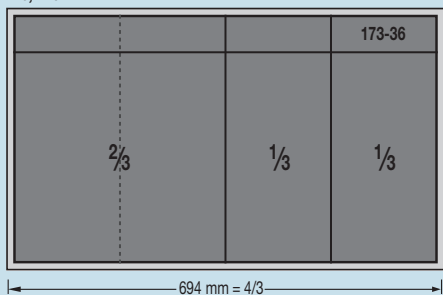

Tool Set

ⓔ 6.3 1/4 12⁵ 1/2



With plastic drawer insert 161 PL, PUR foam inserts 854-1 PUR and 900 PUR for HAZET-Assistent[®] 162 C, 166 C, 169 N, 173, 174, 177, 178, 179, 180

58 pieces
Socket Set complete (3/3)
Made in Germany

- Contents:
- 850-4 5 6 7 8 9 10 11 12 13 14
 - 863 P 865 866 U 867-2 868 869
 - 8501-3 4 5 6 8
 - 8503-0.6 x 3.5 0.8 x 4 1 x 5.5 1.2 x 8
 - 8506-PH 1 PH 2 PH 3 PH 4
 - 8507-PZ 1 PZ 2 PZ 3
 - 900-10 11 12 13 14 15 16
 - 17 18 19 20 21 22 23
 - 24 26 27 28 30 32
 - 915 916 SP 917-5 918-10 920

HAZET No.	EAN-No. 4000896+
161 P/58	004904
Plastic drawer insert, empty for 161 P/55, 161 P/58	
161 PL	004911
PUR foam insert, empty for 900, 900 Z	
900 PUR	044078



4 pieces
Tool Set, Pliers and Scrapers, complete (1/3)
Made in Germany

- Contents:
- 823 824
 - 1846 a-2 1846 c-2

HAZET No.	EAN-No. 4000896+
161-22 P/4	004508
Plastic drawer insert, empty for 161-22 P/4	
161-22 PL	004515



3 pieces
Pliers Set, complete (1/3)
Made in Germany

Tool Set

Contents:
760 N-2
1802-22 1841 a-22

HAZET No.	EAN-No. 4000896+
161-23 P/3	004522
Plastic drawer insert, empty for 161-23 P/3	
161-23 PL	004539



8 pieces
Tool Set, Hammers and Chisels, complete (1/3)
Made in Germany

- Contents:
- 730-3 6
 - 746-1
 - 748 b-3 4 5 6
 - 2140-5

HAZET No.	EAN-No. 4000896+
161-24 P/8	004546
Plastic drawer insert, empty for 161-24 P/8	
161-24 PL	004553



3 pieces
Tool Set, Hammers and Grip Pliers, complete (1/3)
Made in Germany

- Contents:
- 757-7 10
 - 1952-35

HAZET No.	EAN-No. 4000896+
161-25 P/3	004560
Plastic drawer insert, empty for 161-25 P/3	
161-25 PL	004577



18 pieces
Combination Wrench Set complete (2/3)
Made in Germany



General Workshop Equipment – Tool Modules

Tool Set

Contents:

603-6 7 8 9 10 11 12 13 14
15 16 17 18 19 21 22 24 27

HAZET No.	EAN-No. 4000896+
161-26 P/18	004584
Plastic drawer insert, empty for 161-26 P/18	
161-26 PL	004591



11 pieces
Double Open-End Wrench Set, complete
Made in Germany

Contents:

450 N-6 x 7 8 x 9 10 x 11 12 x 13
14 x 15 16 x 17 18 x 19 21 x 22
24 x 27 30 x 32 34 x 36

HAZET No.	EAN-No. 4000896+
161-27 P/11	004607
Plastic drawer insert, empty for 161-27 P/11	
161-27 PL	004614



17 pieces
Combination Wrench Set, complete
Made in Germany

Contents:

600 N-6 7 8 9 10 11 12 13 14
15 16 17 18 19 21 22 24

HAZET No.	EAN-No. 4000896+
161-28 P/17	004621
Plastic drawer insert, empty for 161-28 P/17	
161-28 PL	004638



... the demonstration van is coming

Tool Set



9 pieces
Double Box-End Wrench Set, complete
Made in Germany

Contents:

630-6 x 7 8 x 9 10 x 11 12 x 13 14 x 15
16 x 17 18 x 19 20 x 22 21 x 23

HAZET No.	EAN-No. 4000896+
161-29 P/9	004645
Plastic drawer insert, empty for 161-29 P/9	
161-29 PL	004652



11 pieces
Double Box-End Wrench Set, complete
Made in Germany

Contents:

610 N-6 x 7 8 x 9 10 x 11 12 x 13
14 x 15 16 x 17 18 x 19 21 x 22
24 x 26 27 x 32 30 x 34

HAZET No.	EAN-No. 4000896+
161-31 P/11	004683
Plastic drawer insert, empty for 161-31 P/11	
161-31 PL	004690



11 pieces
Tool Set, Screwdriver Sockets, complete
Made in Germany

Contents:

986 Lg-5 7 10 986 S Lg-6 8
990 Lg-8 990 S Lg-10 12
992 Lg-T 70 992 S Lg-T 45 T 55

HAZET No.	EAN-No. 4000896+
161-32 P/11	053995
Plastic drawer insert, empty for 161-32 P/11	
161-32 PL	053926

Tool Set



4 pieces
Tool Set, Lockring Pliers, complete
Made in Germany

Contents:

1846 a-2 1846 b-2 1846 c-2 1846 d-2

HAZET No.	EAN-No. 4000896+
161-35 P/4	053988
Plastic drawer insert, empty for 161-35 P/4	
161-35 PL	053957



8 pieces
Ratcheting Box-End Wrench Set, complete

Contents:

620-6 x 7 8 x 9 10 x 11 12 x 13
14 x 15 16 x 18 17 x 19 21 x 22

HAZET No.	EAN-No. 4000896+
161-36 P/8	057047
Plastic drawer insert, empty for 161-36 P/8	
161-36 PL	057030



8 pieces
Ratcheting Box-End Wrench Set, complete

Contents:

621-6 x 7 8 x 9 10 x 11 12 x 13
14 x 15 16 x 18 17 x 19 21 x 22

HAZET No.	EAN-No. 4000896+
161-37 P/8	057023



8 pieces
Double Box-End Wrench Set, complete
Made in Germany

Contents:

630-6 x 7 8 x 9 10 x 11 12 x 13
14 x 15 16 x 17 18 x 19 21 x 22

HAZET No.	EAN-No. 4000896+
161-39 P/8	059522
Plastic drawer insert, empty for 161-39 P/8	
161-39 PL	059515



Tool Set

(E) 10 3/8"



22 pieces
Tool Set, Screwdriver Sockets, complete (1/3)
Made in Germany

Contents:
8801 K-3 4 5 6 7 8 9 10
8802-T 15 T 20 T 25 T 27
T 30 T 40 T 45 T 50
8808 Lg-8 10
8808-5 6 8 10

HAZET No.	EAN-No. 4000896+
161-41 P/22	060948

Plastic drawer insert, empty for 161-41 P/22

161-41 PL	060856
-----------	--------

(E) 10 3/8"



17 pieces
Socket Set, complete (1/3)
Made in Germany

Contents:
880-10 11 12 13 14 15
16 17 18 19 21 22
8816 P 8820 8821-3 6 10

HAZET No.	EAN-No. 4000896+
161-42 P/17	061273

Plastic drawer insert, empty for 161-42 P/17

161-42 PL	060863
-----------	--------

(E) 6.3 1/4"



45 pieces
Socket Set, complete (1/3)
Made in Germany

Contents:
850-4 5 5,5 6 7 8
9 10 11 12 13 14
850-E 4 E 5 E 6 E 7 E 8 E 10 E 11
863 P 866 U 867-2 868 869
8501-3 4 5 6 8
8502-T 8 T 9 T 10 T 15 T 20
T 25 T 27 T 30 T 40
8503-0,6 x 3,5 1 x 5,5 1,2 x 8
8506-PH 1 PH 2 8507-PZ 1 PZ 2

HAZET No.	EAN-No. 4000896+
161-43 P/45	060924

Plastic drawer insert, empty for 161-43 P/45

161-43 PL	060870
-----------	--------

Tool Set

(E) 12.5 1/2"



13 pieces
Tool Set, Screwdriver Sockets, complete (1/3)
Made in Germany

Contents:
990 Lg-6 8
990 S Lg-10 12
990-6 8 10 12
992-T 30 H T 40 H T 45 H
T 50 H T 55 H

HAZET No.	EAN-No. 4000896+
161-44 P/13	060917

Plastic drawer insert, empty for 161-44 P/13

161-44 PL	060887
-----------	--------

(E) 12.5 1/2"



10 pieces
Tool Set, Screwdriver Sockets complete (1/3)
Made in Germany

Contents:
986-5 6 7 8 10
986 Lg-5 7 10
986 S Lg-6 8

HAZET No.	EAN-No. 4000896+
161-45 P/10	060900

Plastic drawer insert, empty for 161-45 P/10

161-45 PL	060894
-----------	--------

(E)



9 pieces
TORX® Screwdriver Set, complete (1/3)

Contents:
828-T 6 T 7 T 8 T 9 T 10
T 15 T 20 T 25 T 30

HAZET No.	EAN-No. 4000896+
161-46 P/9	061976

Plastic drawer insert, empty for 161-46 P/9

161-46 PL	061891
-----------	--------

Tool Set

(E)



8 pieces
Screwdriver Set, complete (1/3)

Contents:
828-2 2,5 3 4 5 6 8 10

HAZET No.	EAN-No. 4000896+
161-47 P/8	061983

Plastic drawer insert, empty for 161-47 P/8

161-47 PL	061907
-----------	--------

(E) 12.5 1/2"



28 pieces
Socket Set, complete (1/3)
Made in Germany

Contents:
900-12 17 18 19 20 21
22 24 27 30 32
900 Z- 8 9 10 11 12
13 14 15 16
17 18 19 30
916 SP 917-5 918-10 920

HAZET No.	EAN-No. 4000896+
161-49 P/28	074235

Plastic drawer insert, empty for 161-49 P/28

161-49 PL	073450
-----------	--------

(E) 6.3 1/4"



42 pieces
Socket Set, complete (1/3)
Made in Germany

Contents:
850-4 5 5,5 6 7 8
9 10 11 12 13 14
8501-3 4 5 6 8
8503-0,6 x 3,5 1 x 5,5 1,2 x 8
8506-PH 1 PH 2
8507-PZ 1 PZ 2
863 P 865 866 U
867-2 868 869

HAZET No.	EAN-No. 4000896+
161-50 P/30	100835

Plastic drawer insert, empty for 161-50 P/30

161-50 PL	095247
-----------	--------

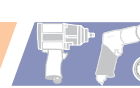

Tool Set



58 pieces
TORX® Socket Set, complete

Made in Germany

Contents:

- 609-E 6 x E 8 E 10 x E 12
E 14 x E 18 E 20 x E 24
- 803-T 6 T 7 T 8 T 9 T 10
T 15 T 20 T 25 T 27 T 30
- 850-E 4 E 5 E 6 E 7 E 8
- 880-E 10 E 11 E 12 E 14
- 8802-T 40 T 45
- 900-E 16 E 18 E 20 E 24
- 992-T 50 T 55 T 60
- 2115-T 6 T 7 T 8 T 9
T 10 T 15 T 20 T 25
T 27 T 30 T 40
- 2223-T 6
- 2223-T 7 H T 8 H T 9 H
T 10 H T 15 H T 20 H
T 25 H T 27 H T 30 H
T 40 H
- 2223 Lg-T 25
- 2250-1 2 2264

HAZET No.	EAN-No. 4000896+
161-52 P/58	100842
Plastic drawer insert, empty for 161-52 P/58	
161-52 PL	095261

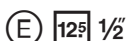

27 pieces
Socket Set, complete

Made in Germany

Contents:

- 900-10 11 12 13 14 15 16
17 18 19 20 21 22 23
24 26 27 28 30 32 34
- 915 916 SP 917-5
- 918-10 920

HAZET No.	EAN-No. 4000896+
161-53 P/27	100859
Plastic drawer insert, empty for 161-53 P/27	
161-53 PL	095575

Tool Set



4 pieces
Pliers Set, complete

(1/3)

Contents:

- 759 N-2 1802 M-22 1841 M b-33 1850 M-22

HAZET No.	EAN-No. 4000896+
161-54 P/4	098491
Plastic drawer insert, empty for 161-54 P/4	
161-54 PL	098477



4 pieces
File Set, complete

(1/3)

Contents:

- 2119-8 2120-8 2122-8 2123-8

HAZET No.	EAN-No. 4000896+
161-56 P/4	098484
Plastic drawer insert, empty for 161-56 P/4	
161-56 PL	098460



4 pieces
Hex Nut Driver Set complete

(1/3)

Contents:

- 428-7 8 10 13

HAZET No.	EAN-No. 4000896+
161-57 P/4	109265
Plastic drawer insert, empty for 161-57 P/4	
161-57 PL	109258



13 pieces
Tool Set, complete

(1/3)

Contents:

- 824
- 1952-35
- 2105 Lg-015 02 025 03 04 05 06 08 10
- 2147 MS
- 2154-2

HAZET No.	EAN-No. 4000896+
161-58 P/13	121700
Plastic drawer insert, empty for 161-58 P/13	
161-58 PL	119646

Tool Set



9 pieces
Tool Set, complete

(1/3)

Contents:

- 858-1 8858-1 2
- 958-1 2
- 1058-2 1979-10
- 2150 2154-10

HAZET No.	EAN-No. 4000896+
161-59 P/9	121724
Plastic drawer insert, empty for 161-59 P/9	
161-59 PL	119653



42 pieces
Socket Set, complete

(1/3)

Made in Germany

Contents:

- 850-4 5 5,5 6 7 8
9 10 11 12 13 14
- 850 Lg-4 5 5,5 6 7 8 9 10 11 12 13
- 8501-3 4 5 6 8
- 8503-0,6 x 3,5 1 x 5,5 1,2 x 8
- 8506-PH 1 PH 2
- 8507-PZ 1 PZ 2
- 858-1 863 P
- 865 866 U
- 867-2 868 869

HAZET No.	EAN-No. 4000896+
161-60 P/42	123049
Plastic drawer insert, empty for 161-60 P/42	
161-60 PL	123032



3 pieces
Automatic Grip Pliers Set complete

(1/3)

Contents:

- 755-6 A 7 A 10 A

HAZET No.	EAN-No. 4000896+
161-61 P/3	126552
Plastic drawer insert, empty for 161-61 P/3	
161-61 PL	126545



Tool Set

(E) 12⁵/₁₆"



29 pieces
Tool Set, Screwdriver Sockets and Extensions complete
Made in Germany

Contents:
986-5 6 7 8 10 12 14 17 19
986 KK-6 7 8 10
990-5 6 8 10 12 14 16 18
990 Lg-8 12
990 S Lg-12
917-1 919-1 5 10

HAZET No.	EAN-No. 4000896+
161-62 P/29	147182

Plastic drawer insert, empty for 161-62 P/29	
161-62 PL	147137



11 pieces
6-Point Offset Socket Wrench Set, complete (1/3)

Contents:
435-8 10 11 12 13 14
15 16 17 18 19

HAZET No.	EAN-No. 4000896+
435/11	079551

Plastic drawer insert, empty for 435/11	
435/11 PL	079797



8 pieces
Double Open-End Wrench Set, complete (1/3)
Made in Germany

Contents:
450 N-6 x 7 8 x 9 10 x 11 12 x 13
14 x 15 16 x 17 18 x 19 21 x 22

HAZET No.	EAN-No. 4000896+
450 N/8	020850

Plastic drawer insert, empty for 450 N/8	
450/8 PL	061761

Tool Set



8 pieces
Combination Wrench Set complete (1/3)
Made in Germany

Contents:
600 N-10 11 13 14 15 17 19 22

HAZET No.	EAN-No. 4000896+
600 N/8	023387

Plastic drawer insert, empty for 600 N/8	
600 N/8 PL	057139



6 pieces
Ratcheting Combination Wrench Set, complete (1/3)

Contents:
606-8 10 12 13 17 19

HAZET No.	EAN-No. 4000896+
606/6	115907

Plastic drawer insert, empty for 606/6	
606/6 PL	115914



12 pieces
Ratcheting Combination Wrench Set, complete (2/3)

Contents:
606-8 9 10 11 12 13
14 15 16 17 18 19

HAZET No.	EAN-No. 4000896+
606/12	118038

Plastic drawer insert, empty for 606/12	
606/12 PL	118045



6 pieces
HEXAnamic Screwdriver Set complete (1/3)

Tool Set

Contents:
802-40 55 65 80
802-PH 1 PH 2

HAZET No.	EAN-No. 4000896+
802/6	145560

Plastic drawer insert, empty for 802/6	
802/6 PL	147267



5 pieces
HEXAnamic TORX® Screwdriver Set complete (1/3)

Contents:
802-T 10 H T 15 H T 20 H T 25 H T 30 H

HAZET No.	EAN-No. 4000896+
802 T H/5	145591

Plastic drawer insert, empty for 802 TH/5	
802 TH/5 PL	147274



6 pieces
trinamic® Screwdriver Set, complete (1/3)

Contents:
803-40 55 65 80
803-PH 1 PH 2

HAZET No.	EAN-No. 4000896+
803/6	080373

Plastic drawer insert, empty for 803/6, 803/6-1, 803/6-2	
803/6 PL	083176



10 pieces
trinamic® Screwdriver Set, complete (1/3)

Contents:
803-25 30 35 40 65 80
803-PH 1 PH 2
801 K-55 801 K-PH 2

HAZET No.	EAN-No. 4000896+
803/10	080236

Plastic drawer insert, empty for 803/10	
803/10 PL	083183



General Workshop Equipment – Tool Modules

Tool Set



13 pieces
trinamic® Screwdriver Set, complete (2/3)

Contents:
801 K-55 801 K-PH 2
803-25 30 35 40 65 80
803-PZ 1 PZ 2
803-PH 1 PH 2 PH 3

HAZET No.	EAN-No. 4000896+
803/13	098514
Plastic drawer insert, empty for 803/13	
803/13 PL	098521



6 pieces
trinamic® VDE Screwdriver Set complete (1/3)

Contents:
803 VDE-25 40 55 65
803 VDE-PH 1 PH 2

HAZET No.	EAN-No. 4000896+
803 VDE/6	080229
Plastic drawer insert, empty for 803 VDE/6	
810 VDE/6 PL	057146

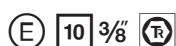

10 pieces
Universal Joint Socket Set, complete (2/12)

Contents:
880 G-10 11 12 13 14 15 16 17 18 19

HAZET No.	EAN-No. 4000896+
880 G/10	121090
Plastic drawer insert, empty for 880 G/10	
880 G/10 PL	121083

Tool Set



5 pieces
TORX® Socket Set, complete (1/12)

Contents:
900-E 10 E 12 E 14 E 16 E 18

HAZET No.	EAN-No. 4000896+
900-E/5	129331
Plastic drawer insert, empty for 900-E/5, 986-P/5, 990-P/5, 992 H-P/5	
2191-1 PL	054350



5 pieces
Tool Set, Screwdriver Sockets, complete (1/12)

Contents:
986-5 6 7 8 10

HAZET No.	EAN-No. 4000896+
986-P/5	054145
Plastic drawer insert, empty for 900-E/5, 986-P/5, 990-P/5, 992 H-P/5	
2191-1 PL	054350



6 pieces
Tool Set, Screwdriver Sockets, complete (2/12)

Contents:
986 KK-5 6 7 8 10 12

HAZET No.	EAN-No. 4000896+
986 KK-P/6	054091
Plastic drawer insert, empty for 986 KK-P/6	
2191-22 PL	054381



5 pieces
Tool Set, Screwdriver Sockets, complete (3/12)

Contents:
986 Lg-5 7 10
986 S Lg-6 8

HAZET No.	EAN-No. 4000896+
986 S Lg-P/5	054039
Plastic drawer insert, empty for 986 S Lg-P/5	
2191-3 PL	054374

Tool Set



5 pieces
Tool Set, Screwdriver Sockets, complete (1/12)

Contents:
990-5 6 8 10 12

HAZET No.	EAN-No. 4000896+
990-P/5	054053
Plastic drawer insert, empty for 900-E/5, 986-P/5, 990-P/5, 992 H-P/5	
2191-1 PL	054350



3 pieces
Tool Set, Screwdriver Sockets complete (1/12)

Contents:
990 Lg-8
990 S Lg-10 12

HAZET No.	EAN-No. 4000896+
990 S Lg-P/3	054046
Plastic drawer insert, empty for 990 S Lg-P/3	
2191-11 PL	054367



5 pieces
Tool Set, Screwdriver Sockets, complete (1/12)

Contents:
992-T 30 H T 40 H T 45 H T 50 H T 55 H

HAZET No.	EAN-No. 4000896+
992 H-P/5	054152
Plastic drawer insert, empty for 900-E/5, 986-P/5, 990-P/5, 992 H-P/5	
2191-1 PL	054350

Tool Trolley Accessories



5 small plastic drawer inserts
for drawers on Tool Trolleys Assistant 173, 179, 180
H 40 x W 170 x D 50 mm

HAZET No.	EAN-No. 4000896+
173-36/5	090167



HAZET tool assortments in Safety-Insert-System 2-component soft foam inserts

- ✓ **Safety-Insert-System** – all tools are snugly embedded – Missing tools are noticed immediately
- ✓ **Cleaning inserts:** brush under running water – let it dry – ready
- ✓ **Inserts suitable for HAZET-Tool Trolleys Assistant with drawers.** For Tool Trolleys Assistant 173, 179, 179 XL and 180 we recommend usage of the plastic insert 173-36/5 or the soft foam inserts 163-522x40 and 163-172x40 or 163-522x50 and 163-172x50



162 C / 166 C, 168, 169 N, 174, 176, 177, 177 W, 178

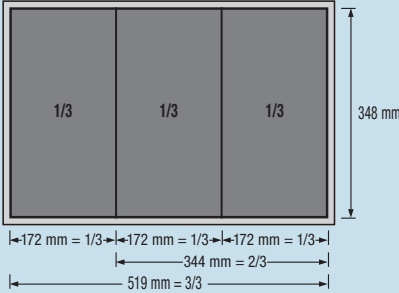

179, 179 W, 179 BIG-1, 180

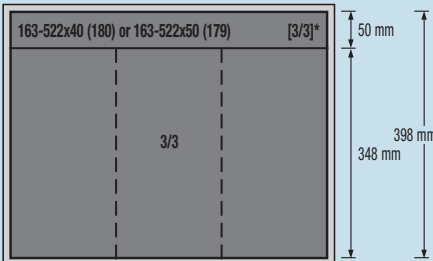

* Optionally [1/3]: 163-172x40 (180) or 163-172x50 (179)
173, 179 XL

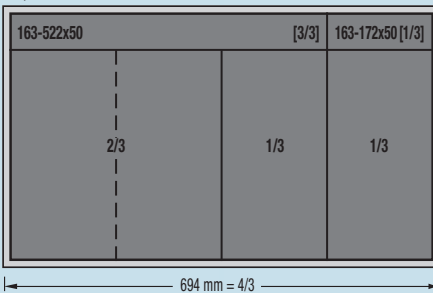

Tool Set in Safety-Insert-System



25 pieces
Wrench Set
Combination Wrenches, Double Box-End Wrenches
Made in Germany

- Contents:
600 N-6 7 8 9 10 11 12 13 14
15 16 17 18 19 21 22 24
630-6 x 7 8 x 9 10 x 11 12 x 13
14 x 15 16 x 17 18 x 19 21 x 22

HAZET No.	EAN-No. 4000896+
163-30/25	118601
2-component soft foam insert empty for 163-30/25	
163-30 L	118595



27 pieces
Tool Set
Screwdrivers, Pliers etc.
Made in Germany

Contents:
730-3 6 746-1
748 B-3 4 5 6
759 N-2
801 K-55 801 K-PH 2
803-25 30 35 40 65 80
803-PH 1 PH 2
803-T 10 T 15 T 20 T 25 T 30
1802 M-22 1841 M b-33 1850 M-22
2140-5

HAZET No.	EAN-No. 4000896+
163-31/27	118618
2-component soft foam insert empty for 163-31/27	
163-31 L	118625

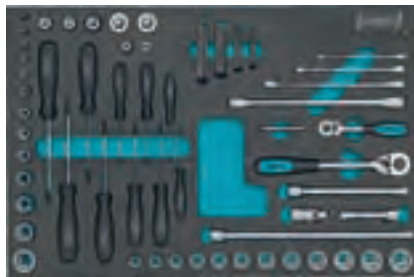

75 pieces
TORX® Socket Set
Double Box-End Wrenches, Sockets, etc.
Made in Germany

Tool Set in Safety-Insert-System



- Contents:
609-E 6 x E 8 E 10 x E 12
E 14 x E 18 E 20 x E 24
803-T 6 T 7 T 8 T 9 T 10
T 15 T 20 T 25 T 27 T 30
850-E 4 E 5 E 6 E 7 E 8
880-10 11 12 13 14 15
16 17 18 19 21 22
880-E 10 E 11 E 12 E 14
8802-T 40 T 45
8816 P 8820
8821-3 6 10
900-E 16 E 18 E 20 E 24
992-T 50 T 55 T 60
2115-T 6 T 7 T 8 T 9 T 10 T 15
T 20 T 25 T 27 T 30 T 40
2223-T 6
2223-T 7 H T 8 H T 9 H T 10 H T 15 H
T 20 H T 25 H T 27 H T 30 H T 40 H
2223 Lg-T 25
2250-1 2
2264

HAZET No.	EAN-No. 4000896+
163-53/75	122783
2-component soft foam insert empty for 163-53/75	
163-53 L	122509



15 pieces
Tool Set
Double Box-End Wrenches, Circlip Pliers
Made in Germany

Contents:
610 N-6 x 7 8 x 9 10 x 11 12 x 13
14 x 15 16 x 17 18 x 19 21 x 22
24 x 26 27 x 32 30 x 34
1846 A-2 1846 B-2
1846 C-2 1846 D-2

HAZET No.	EAN-No. 4000896+
163-54/15	122790



15 pieces
Tool Set
Double Open End Wrenches, Files
Made in Germany

Contents:
450 N-6 x 7 8 x 9 10 x 11 12 x 13
14 x 15 16 x 17 18 x 19 21 x 22
24 x 27 30 x 32 34 x 36
2119-8 2120-8 2122-8 2123-8

HAZET No.	EAN-No. 4000896+
163-55/15	122806



General Workshop Equipment – Tool Modules

Tool Set in Safety-Insert-System

(E) 6.3 1/4 12.5 1/2



56 pieces
Socket Set

Made in Germany

Contents:

- 850-4 5 5,5 6 7 8
9 10 11 12 13 14
- 8501-3 4 5 6 8
- 8503-0,6 x 3,5 1 x 5,5 1,2 x 8
- 8506-PH 1 PH 2
- 8507-PZ 1 PZ 2
- 863 P 865 866 U
- 867-2 868 869
- 900-10 11 12 13 14 15 16
17 18 19 20 21 22 23 24
26 27 28 30 32 34
- 915 916 SP
- 917-5 918-10 920

HAZET No.	EAN-No. 4000896+
163-57/56	122837

2-component soft foam insert empty for 163-57/56

163-57 L	122752
----------	--------

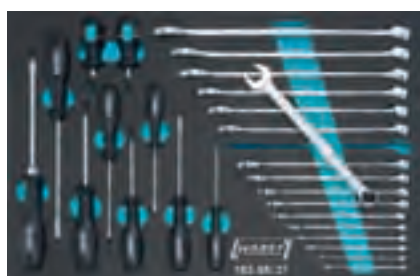

27 pieces

Tool Set

Combination Wrenches, Screwdrivers

Contents:

- 600 N-6 7 8 9 10 11 12 13 14
15 16 17 18 19 21 22 24
- 803-25 30 35 40 65 80
- 803-PH 1 PH 2
- 801 K-55 801 K-PH 2

HAZET No.	EAN-No. 4000896+
163-58/27	122844

2-component soft foam insert empty for 163-58/27

163-58 L	122769
----------	--------



Tool Set in Safety-Insert-System

12 pieces

Tool Set

Double Box-End Wrenches, Pliers

Made in Germany

Contents:

- 630-6 x 7 8 x 9 10 x 11 12 x 13 14 x 15
16 x 17 18 x 19 20 x 22 21 x 23
- 760 N-2
- 1802-22 1841 A-22

HAZET No.	EAN-No. 4000896+
163-59/12	122820

2-component soft foam insert empty for 163-59/12

163-59 L	122745
----------	--------



22 pieces

Tool Set

Hex Head Wrenches, various tools

Made in Germany

Contents:

- 730-3 6 746-1
- 748 B-3 4 5 6
- 824
- 1952-35
- 1976
- 2105 Lg-015 02 025 03 04 05 06 08 10
- 2140-5 2147 MS 2154-2

HAZET No.	EAN-No. 4000896+
163-60/22	122851

2-component soft foam insert empty for 163-60/22

163-60 L	122776
----------	--------

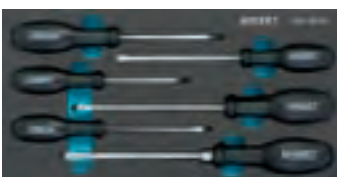

6 pieces

Screwdriver Set

(SmartCase L 1/3)

Contents:

- 803-40 55 65 80
- 803-PH 1 PH 2

HAZET No.	EAN-No. 4000896+
163-93/6	145645

2-component soft foam insert empty for 163-93/6

163-93 L	145942
----------	--------



Tool Set in Safety-Insert-System

10 pieces

Screwdriver Set

(E) (SmartCase L 1/3)

Contents:

- 803-25 30 35 40 65 80
- 803-PH 1 PH 2
- 801 K-55 801 K-PH 2

HAZET No.	EAN-No. 4000896+
163-94/10	145652

2-component soft foam insert empty for 163-94/10

163-94 L	145959
----------	--------



8 pieces

Double Open End Wrench Set

(SmartCase L 1/3)

Made in Germany

Contents:

- 450 N-6 x 7 8 x 9 10 x 11 12 x 13
14 x 15 16 x 17 18 x 19 21 x 22

HAZET No.	EAN-No. 4000896+
163-95/8	145669

2-component soft foam insert empty for 163-95/8

163-95 L	145966
----------	--------

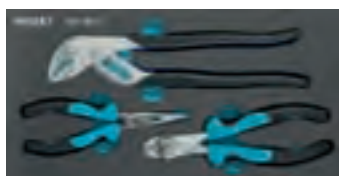

3 pieces

Pliers Set

(SmartCase L 1/3)

Made in Germany

Contents:

- 760 N-2
- 1802-22 1841 a-22

HAZET No.	EAN-No. 4000896+
163-96/3	145676

2-component soft foam insert empty for 163-96/3

163-96 L	145973
----------	--------



6 pieces

Ratcheting Combination Wrench Set

(SmartCase L 1/3)

Contents:

- 606-8 10 12 13 17 19

HAZET No.	EAN-No. 4000896+
163-97/6	145683

2-component soft foam insert empty for 163-97/6

163-97 L	145980
----------	--------



Tool Set in Safety-Insert-System



17 pieces
Combination Wrench Set
Made in Germany

Contents:
600 N-6 7 8 9 10 11 12 13 14
15 16 17 18 19 21 22 24

HAZET No.	EAN-No. 4000896+
163-98/17	145690
2-component soft foam insert empty for 163-98/17	
163-98 L	145997



18 pieces
Combination Wrench Set
Made in Germany

Contents:
603-6 7 8 9 10 11 12 13 14
15 16 17 18 19 21 22 24 27

HAZET No.	EAN-No. 4000896+
163-99/18	145706
2-component soft foam insert empty for 163-99/18	
163-99 L	146000

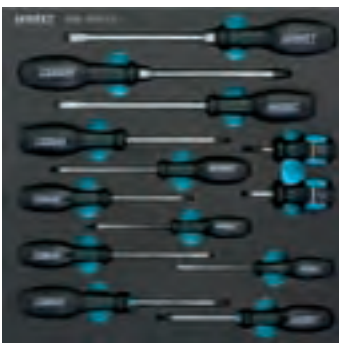

13 pieces
Screwdriver Set

Contents:
801 K-55 801 K-PH 2
803-25 30 35 40 65 80
803-PZ 1 PZ 2
803-PH 1 PH 2 PH 3

Tool Set in Safety-Insert-System

HAZET No.	EAN-No. 4000896+
163-100/13	145713
2-component soft foam insert empty for 163-100/13	
163-100 L	146017



9 pieces
Double Box-End Wrench Set
Made in Germany

Contents:
630-6 x 7 8 x 9 10 x 11 12 x 13 14 x 15
16 x 17 18 x 19 20 x 22 21 x 23

HAZET No.	EAN-No. 4000896+
163-101/9	145720
2-component soft foam insert empty for 163-101/9	
163-101 L	146024



26 pieces
Socket Set, complete
Made in Germany

Contents:
900-10 11 12 13 14 15 16 17 18 19 20
21 22 23 24 26 27 28 30 32 34
915 916 SP 917-5 918-10 920

HAZET No.	EAN-No. 4000896+
163-102/27	145935
2-component soft foam insert empty for 163-102/27	
163-102 L	146031



Tool Set in Safety-Insert-System

57 pieces
Socket Set complete
Made in Germany (3/3)

Contents:
850-4 5 5,5 6 7 8
9 10 11 12 13 14
8501-3 4 5 6 8
8503-0,6 x 3,5 1 x 5,5 1,2 x 8
8506-PH 1 PH 2 8507-PZ 1 PZ 2
863P 865 866 U 867-2 868 869
900 Z-10 11 12 13 14 15 16 17 18 19 20
21 22 23 24 26 27 28 30 32 34
915 916 SP 919-5 919-10 920 919-1

HAZET No.	EAN-No. 4000896+
163-118/57	153497
2-component soft foam insert empty for 163-118/57	
163-118 L	153480



23 pieces
Screwdriver Sockets complete
Made in Germany (2/3)

Contents:
986-5 6 7 8 10 12 14 17 19
986 KK-6 7 8 10
990-8 10 12 14 16 18
990 Lg-8 14
990 S Lg-10 12

HAZET No.	EAN-No. 4000896+
163-119/23	153510
2-component soft foam insert empty for 163-119/23	
163-119 L	153503



24 pieces
Universal Set complete (3/3)

Contents:
730-3 6 746-1
748 B-3 4 5 6
759 N-2
801 K-55 801 K-PH 2
803-25 30 35 40 65 80
803-PH 1 PH 2 PH 3
1802 M-22 1841 MB-33 1850 M-22
2105 Lg-015 02 025 03 04 05 06 08 10
2140-5



General Workshop Equipment - Tool Modules

Tool Set in Safety-Insert-System



HAZET No.	EAN-No. 4000896+
163-120/24	153572
2-component soft foam insert empty for 163-120/24	
163-120 L	153565



4 pieces
Pliers Set complete (SmartCase L 1/3)

Contents:
755-10 A 1802 M-33
1803 M-11 1841 MA-11

HAZET No.	EAN-No. 4000896+
163-121/4	153541
2-component soft foam insert empty for 163-121/4	
163-121 L	153558



3 pieces
Hex Nut-Driver Set complete (SmartCase L 1/3)

Contents:
428-8 10 13

HAZET No.	EAN-No. 4000896+
163-122/3	153534
2-component soft foam insert empty for 163-122/3	
163-122 L	153527



4 pieces
Lockring Pliers Set complete (SmartCase L 1/3)
Made in Germany

Contents:
1845 A-19 1845 B-19
1845 C-19 1845 D-19

HAZET No.	EAN-No. 4000896+
163-124/4	153602
2-component soft foam insert empty for 163-124/4	
163-124 L	153596

Tool Set in Safety-Insert-System



8 pieces
Socket Set complete (3/3 extension)
Made in Germany

Contents:
858-1
8858-1 2
958-1 2
1058-2
903 S Lg-17 19

HAZET No.	EAN-No. 4000896+
163-131/8	153626
2-component soft foam insert empty for 163-131/8	
163-131 L	153619

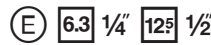

77 pieces
Socket Set complete (3/3)
Suitable for HAZET Tool Trolleys Assistant 173, 179, 179 BIG-1, 179 XL and 180 with a drawer depth of 398 mm
Made in Germany

Contents:
850-4 5 5,5 6 7 8
9 10 11 12 13 14
850 Lg-4 5 5,5 6 7 8 9 10 11 12 13
8501-3 4 5 6 8
8503-0,6 x 3,5 1 x 5,5 1,2 x 8
8506-PH 1 PH 2 8507-PZ 1 PZ 2
863 P 858-1 865 866 U
867-2 868 869
900-10 11 12 13 14 15 16 17
18 19 20 21 22 24 27 30 32
903 S Lg-17 19
986-5 6 7 8 10 12 14 17
915 916 SP 917-5 918-10
919-1 920 958-1 2

HAZET No.	EAN-No. 4000896+
163-138/77	151875
2-component soft foam insert empty for 163-138/77	
163-138 L	151516

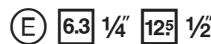

Tool Set in Safety-Insert-System

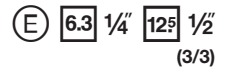

90 pieces
Socket Set complete (3/3)
Suitable for HAZET Tool Trolleys Assistant 173, 179, 179 BIG-1, 179 XL and 180 with a drawer depth of 398 mm
Made in Germany

Contents:
609-E 6 x E 8 E 10 x E 12
E 14 x E 18 E 20 x E 24
850-E 4 E 5 E 6 E 7 E 8
880-E 10 E 11 E 12 E 14
880-7 8 9 10 11
12 13 14 15 16
17 18 19 21 22
880 Lg-10 11 12 13
880 G-10 11 12 13 14 15 16
880 G-E 8 E 10
8801 K-9
8802-T 40 T 45
8808-6 8 10
8816 GK 8816 P 8820
8858-1 2
8821-3 6 10
900-E 16 E 18 E 20 E 24
992-T 50 T 55 T 60
2115-T 6 T 7 T 8 T 9
T 10 T 15 T 20 T 25
T 27 T 30 T 40
2215-PH 1 PH 2 PH 3
2223-T 6
2223-T 7 H T 8 H T 9 H
T 10 H T 15 H T 20 H
T 25 H T 27 H T 30 H
T 40 H
2223 Lg-T 25
2250-1 2
2264

HAZET No.	EAN-No. 4000896+
163-139/90	151882
2-component soft foam insert empty for 163-139/90	
163-139 L	151523

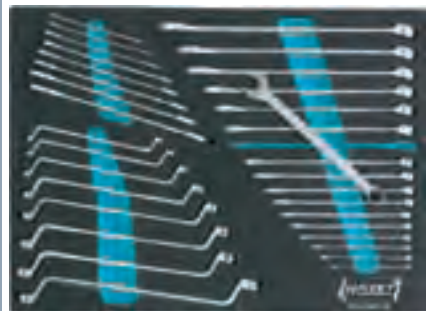

33 pieces
Wrench Set complete (3/3)
Suitable for HAZET Tool Trolleys Assistant 173, 179, 179 BIG-1, 179 XL and 180 with a drawer depth of 398 mm
Made in Germany

Contents:
450 N-6 x 7 8 x 9 10 x 11
12 x 13 14 x 15 16 x 17
18 x 19 21 x 22
600 N-6 7 8 9 10 11
12 13 14 15 16 17
18 19 21 22 24
630-6 x 7 8 x 9 10 x 11
12 x 13 14 x 15 16 x 17
18 x 19 21 x 22

HAZET No.	EAN-No. 4000896+
163-140/33	151899
2-component soft foam insert empty for 163-140/33	
163-140 L	151837



Tool Set in Safety-Insert-System



31 pieces
Screwdriver Set complete
Suitable for HAZET Tool Trolleys Assistant 173, 179, 179 BIG-1, 179 XL and 180 with a drawer depth of 398 mm (3/3)

Contents:
802-30 40 55 65 80 100 120
802-PH 1 PH 2 PH 3
801 K-55 801 K-PH 2
803-T 6 T 7 T 8 T 9 T 10
T 15 T 20 T 25 T 27 T 30
2105 Lg-015 02 025 03 04 05 06 08 10

HAZET No.	EAN-No. 4000896+
163-141/31	151905
2-component soft foam insert empty for 163-141/31	
163-141 L	151844



9 pieces
Pliers Set complete
Suitable for HAZET Tool Trolleys Assistant 173, 179, 179 BIG-1, 179 XL and 180 with a drawer depth of 398 mm (3/3)
Made in Germany

Contents:
757-10 760 N-2
1802-22 1841 A-22
1846 A-2 1846 B-2
1846 C-2 1846 D-2
1850-22

HAZET No.	EAN-No. 4000896+
163-142/9	151912
2-component soft foam insert empty for 163-142/9/3	
163-142 L	151851



Partner of Industry!

Tool Set in Safety-Insert-System



18 pieces
Universal Set complete
Suitable for HAZET Tool Trolleys Assistant 173, 179, 179 BIG-1, 179 XL and 180 with a drawer depth of 398 mm (3/3)

Contents:
426-6 7
612 N-10 x 11
730-3 6 746-1
748 B-3 4 5 6 8
824
1557 TS-1 1952-40
2140-4 2152/3 2154 N-5
4968-2

HAZET No.	EAN-No. 4000896+
163-143/18	151929
2-component soft foam insert empty for 163-143/18	
163-143 L	151868



11 pieces
Offset Socket Wrench Set complete
(2/3)

Contents:
435-8 10 11 12 13 14
15 16 17 18 19

HAZET No.	EAN-No. 4000896+
163-179/11	160648

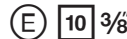

17 pieces
Socket Set complete
(SmartCase L 1/3)
Made in Germany

Contents:
880-10 11 12 13 14 15
16 17 18 19 21 22
8816 P 8820 8821-10 8821-3 8821-6

HAZET No.	EAN-No. 4000896+
163-181/17	162345
2-component soft foam insert empty for 163-181/17	
163-181 L	161492

Tool Set in Safety-Insert-System



9 pieces
T-Handle TORX® Screwdriver Set complete
(SmartCase L 1/3)

Contents:
828-T 6 T 7 T 8 T 9 T 10 T 15 T 20 T 25 T 30

HAZET No.	EAN-No. 4000896+
163-182/9	162352

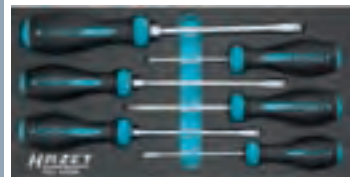

6 pieces
HEXANAMIC Screwdriver Set complete
(SmartCase L 1/3)

Contents:
802-40 55 65 80
PH 1 PH 2

HAZET No.	EAN-No. 4000896+
163-184/6	161461

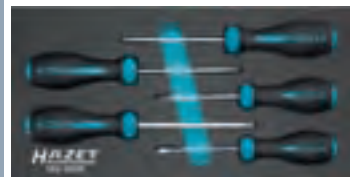

5 pieces
HEXANAMIC TORX® Screwdriver Set complete
(SmartCase L 1/3)

Contents:
802-T 10 H T 15 H T 20 H T 25 H T 30 H

HAZET No.	EAN-No. 4000896+
163-185/5	161478



16 pieces
Ratcheting Combination Wrench Set with square adapters complete
(2/3)

Contents:
606-8 9 10 11 12 13
14 15 16 17 18 19
606-63 850 880 900

HAZET No.	EAN-No. 4000896+
163-186/16	162253
2-component soft foam insert empty for 163-186/16	
163-186 L	162338



General Workshop Equipment – Tool Modules

Tool Set in Safety-Insert-System



6 pieces
T-Handle Screwdriver Set complete (SmartCase L 1/3)

Contents:
829-2 2.5 3 4 5 6

HAZET No.	EAN-No. 4000896+
163-189/6	162260
2-component soft foam insert empty for 163-189/6	
163-189 L	162284



18 pieces
Socket Set complete (SmartCase L 1/3)
Made in Germany

Contents:
900-10 11 12 13 14 15 16
17 18 19 21 22 24 27
916 SP 917-5 918-10 920

HAZET No.	EAN-No. 4000896+
163-191/18	162307



24 pieces
TORX® Socket Set complete (SmartCase L 1/3)
Made in Germany

Contents:
8502-T 10 T 15 T 20
T 25 T 27 T 30 T 40
992-T 30 T 40 T 45 T 50 T 55
850-E 5 E 6 E 7 E 8 E 10
900-E 10 E 12 E 14
E 16 E 18 E 20
2115-T 8 T 10 T 15 T 20
T 25 T 27 T 30 T 40

HAZET No.	EAN-No. 4000896+
163-192/24	162314



40 pieces
Socket and Bit Set complete (SmartCase L 1/3)
Made in Germany

Tool Set in Safety-Insert-System

Contents:
850-5,5 6 7 8 9
10 11 12 13 14
850 Lg-8 10 13
863 P 866 U 867-2 4 865
2204-3 4 5 6 7
2208-6 10 11
2215-PH 1 PH 2 PH 3
2216-PZ 1 PZ 2 PZ 3
2223-T 10 H T 15 H T 20 H T 25 H
T 27 H T 30 H T 40 H
2250-1

HAZET No.	EAN-No. 4000896+
163-193/40	162321
2-component soft foam insert empty for 163-193/40	
163-193 L	162567



3 pieces
Pliers Set complete (SmartCase L 1/3)

Contents:
759 N-2 1802 M-22 1841 M-22

HAZET No.	EAN-No. 4000896+
163-194/3	162536
2-component soft foam insert empty for 163-194/3	
163-194 L	162574



5 pieces
Screwdriver Socket Set complete (SmartCase S 1/9)

- For inside hexagon screws
- □ drive 12.5 = 1/2"
- With knurling

Made in Germany

Contents:
986-5 6 7 8 10

HAZET No.	EAN-No. 4000896+
163-215/5	168217



5 pieces
TORX® Screwdriver Socket Set complete (SmartCase S 1/9)

- Short style
- With front hole
- For tamper resistant TORX® screws (inside TORX® screws with pin)
- □ drive 12.5 = 1/2"
- With knurling

Tool Set in Safety-Insert-System

Made in Germany

Contents:
992-T 30 H T 40 H T 45 H T 50 H T 55 H

HAZET No.	EAN-No. 4000896+
163-216/5	168224



6 pieces
Adapter Set complete (SmartCase S 1/9)
1 Adapter each
Made in Germany

Contents:
858-1 8858-1 2
958-1 2 1058-2

HAZET No.	EAN-No. 4000896+
163-217/6	168231

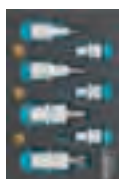

10 pieces
TORX® Screw Driving Tool Set complete (SmartCase S 1/9)

- □ drive 6.3 = 1/4", 10 = 3/8" and 12.5 = 1/2"
- For inside TORX® screws

Made in Germany

Contents:
8502-T 8 T 10 T 15
8802-T 20 T 25 T 30
992-T 40 T 50 T 55 T 60

HAZET No.	EAN-No. 4000896+
163-218/10	168248



13 pieces
Screwdriver Socket Set complete (SmartCase L 1/3)

- For inside hexagon screws
- □ drive 12.5 = 1/2"
- With knurling
- 9 Screwdriver Sockets, short
- 4 Screwdriver Sockets, long, with ball head

Made in Germany

Contents:
986-5 6 7 8 10 12 14 17 19
986 KK-6 7 8 10

HAZET No.	EAN-No. 4000896+
163-220/13	168286



Tool Set in Safety-Insert-System



10 pieces
Screwdriver Socket Set complete (SmartCase L 1/3)
 • For inside screws with internal serration XZN
 • □ drive 12.5 = 1/2"
 • With knurling
Made in Germany

Contents:
 990-8 10 12 14 16 18
 990 Lg-8 14
 990 S Lg-10 12

HAZET No.	EAN-No. 4000896+
163-221/10	168262

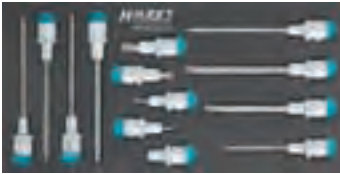

13 pieces
Screwdriver Socket Set complete (SmartCase L 1/3)
 • 5 Screwdriver Sockets with ball head, long pattern, for inside hexagon screws
 • 8 Screwdriver Sockets for inside screws with internal serration XZN
 • □ drive 12.5 = 1/2"
 • With knurling
Made in Germany

Contents:
 990-5 6 8 10 12
 990 Lg-8
 990 S Lg-10 12
 986 KK-5 6 7 8 10

HAZET No.	EAN-No. 4000896+
163-222/13	168279



...for good tools are a matter of trust!

Tool Set in Safety-Insert-System



57 pieces
Socket / Screwdriver Set complete (2/3)

Contents:
 810 SPC-6,3
 850-5,5 6 7 8 9 10 11 12 13
 863 P 867-2 868 869
 900-10 11 12 13 14 15 16
 17 18 19 20 21 22 23
 24 26 27 28 30 32
 915 916 SP 917-5 918-10 920
 2204-3 4 5 6 8
 2208-6 9 10
 2215-PH 1 PH 3 2216-PZ 1 PZ 2
 2223-T 15 T 20 T 25 T 30
 2250-1 2304

HAZET No.	EAN-No. 4000896+
163-224/57	176311

2-component soft foam insert empty for 163-224/57
163-224 L 176328



4 pieces
VDE Pliers Set complete (SmartCase L 1/3)
Made in Germany

Contents:
 759 N-2 VDE 1803 VDE-22 1841 b VDE-33 1850 VDE-22

HAZET No.	EAN-No. 4000896+
163-226/4	177875

2-component soft foam insert empty for 163-226/4
163-226 L 178025



3 pieces
VDE Pliers Set complete (SmartCase L 1/3)
Made in Germany

Contents:
 1802 VDE-22 1804 VDE-33 1860 VDE-11

HAZET No.	EAN-No. 4000896+
163-227/3	177868

2-component soft foam insert empty for 163-227/3
163-227 L 178131

Tool Set in Safety-Insert-System



7 pieces
VDE Screwdriver Set complete (SmartCase L 1/3)
 Contents:
 810 VDE-25 30 35 40
 810 VDE-PH 1 PH 2 PH 3

HAZET No.	EAN-No. 4000896+
163-229/7	177844

2-component soft foam insert empty for 163-229/7
163-229 L 178179

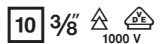

18 pieces
VDE Socket Set complete (SmartCase L 1/3)
 Contents:
 880 VDE-6 7 8 9 10 11 12
 13 14 16 17 18 19 20 22
 8816 VDE 8821 VDE-3 5

HAZET No.	EAN-No. 4000896+
163-230/18	177837

2-component soft foam insert empty for 163-230/18
163-230 L 178148



36 pieces
Socket Set complete (SmartCase L 1/3)
Made in Germany

Contents:
 880-8 10 11 12 13
 14 15 16 17 18
 19 21 22
 880-E 6 E 7 E 8 E 10 E 12 E 14
 8816 P 8820
 8821-5 10
 2204-5 6 7 8
 2215-PH 1 PH 2
 2223-T 10 T 15 T 20
 T 25 T 30 T 40
 2250-2

HAZET No.	EAN-No. 4000896+
163-233/36	178100

2-component soft foam insert empty for 163-233/36
163-233 L 178155



Tool Set in Safety-Insert-System

6.3 1/4" 12.5 1/2"



47 pieces
Socket Set complete (SmartCase L 1/3)

Contents:
 810 SPC-6,3
 850-5 7 8 9 10 11 12 13
 863 P 867-4
 900-10 11 12 13 14 15 16
 17 18 19 21 22 24 27
 916 SP 917-5 918-10
 2204-2 3 4 5 6
 2208-4 6 8
 2215-PH 1 PH 2
 2216-PZ 1 PZ 2
 2223-T 10 T 15 T 20 T 25 T 30
 2250-1 2304

HAZET No.	EAN-No. 4000896+
163-237/47	177936
2-component soft foam insert empty for 163-237/47	
163-237 L	178186

12.5 1/2"



25 pieces
Socket Set complete (SmartCase L 1/3)

Contents:
 900-10 11 12 13 14
 15 16 17 18 19
 21 22 24 27 30 32
 900-E 10 E 12 E 14 E 16 E 18
 916 SP 917-5
 918-10 920

HAZET No.	EAN-No. 4000896+
163-239/25	177943
2-component soft foam insert empty for 163-239/25	
163-239 L	178193

12.5 1/2"

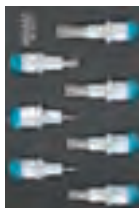

7 pieces
XZN Screwdriver Socket Set complete (SmartCase S 1/9)

Contents:
 990-6 8 10 12 14 16 18

HAZET No.	EAN-No. 4000896+
163-243/7	178032

Tool Set in Safety-Insert-System

12.5 1/2"

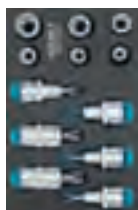

12 pieces
TORX® Tool Set complete (SmartCase S 1/9)

Contents:
 900-E 10 E 12 E 14
 E 16 E 18 E 20
 992-T 30 T 40 T 45
 T 50 T 55 T 60

HAZET No.	EAN-No. 4000896+
163-245/12	178049

12.5 1/2"

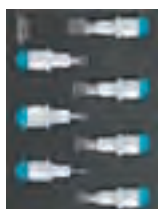

7 pieces
RIBE CV Screwdriver Socket Set complete (SmartCase S 1/9)

Contents:
 991-6 7 8 9 10 12 14

HAZET No.	EAN-No. 4000896+
163-250/7	178056

Soft Foam Inserts with Compartments for Small Pieces

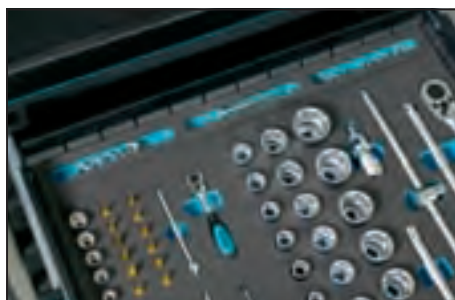

- Safety-Insert-System – all tools are snugly embedded
- Missing tools are noticed immediately
- Inserts suitable for HAZET Tool Trolleys Assistant with drawers.
 For tool trolleys Assistant 173, 179, 179 BIG-1, 179 XL and 180 we recommend usage of the plastic insert 173-36/5 or the soft foam inserts 163-522x40 or 163-522x50

Tool Set in Safety-Insert-System

6.3 1/4"

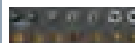

14 pieces
TORX® Tool Set complete (172 x 50 mm)
 Made in Germany

Contents:
 850-E 4 E 5 E 6
 E 7 E 8 E 10 E 11
 8502-T 10 T 15 T 20
 T 25 T 27 T 30 T 40

HAZET No.	EAN-No. 4000896+
163-251/14	178063

10 3/8"



9 pieces
TORX® Tool Set complete (172 x 50 mm)
 Made in Germany

Contents:
 880-E 8 E 10 E 12 E 14
 8802-T 25 T 30 T 40 T 45 T 50

HAZET No.	EAN-No. 4000896+
163-252/9	178070

Soft Foam Insert with empty compartment



2-component soft foam insert, empty (SmartCase L 1/3)

HAZET No.	EAN-No. 4000896+
163-130 L	153589

HAZET No.	EAN-No. 4000896+
-----------	------------------

- 3 compartments for small pieces
 • H 33 x W 522 x D 40 mm
 • Suitable for Tool Trolley Assistant 180
163-522 x 40 141050
- 3 compartments for small pieces
 • H 33 x W 522 x D 50 mm
 • Suitable for Tool Trolleys Assistant 173, 179 and 179 W
163-522 x 50 141043
- 1 compartment for small pieces
 • H 33 x W 172 x D 40 mm
 • Suitable for Tool Trolley Assistant 180
163-172 x 40 154685
- 1 compartment for small pieces
 • H 33 x W 172 x D 50 mm
 • Suitable for Tool Trolleys Assistant 173, 179 and 179 W
163-172 x 50 154692



Tool Case



SmartCase



Without tools.
Complete cases see pages 78, 87–90, 93, 101

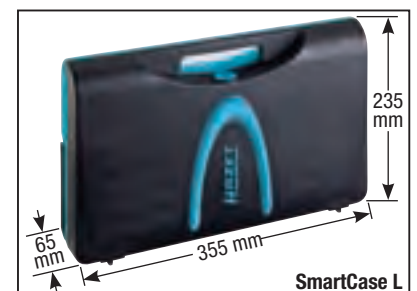

- Modern two-coloured design HAZET-BLUE® / black**
- Bottom of case with pull-out kickstand to prop-up the case, for fast and ergonomic tool access
 - Cover lid may be used as for deposit of tools and small parts
 - Tool case made of sturdy ABS rubber
- Germany** *Made in Germany*

HAZET No.	EAN-No. 4000896+
Case, empty, 183 x 153 x 52 mm Suitable for all 2-component Safety-Insert-Systems (1/9) of the HAZET range	
165-S	167784
Case, empty, 355 x 231 x 65 mm Suitable for all 2-component Safety-Insert-Systems (1/3) of the HAZET range With carrying handle	
165-L	167777



Tool Set for Hybrid and Electric Vehicles



In trolley case

Joint development with one of the leading car manufacturer and in accordance with the German TÜV SÜD

Trolley Case:

- With 4-position telescopic slide-out from 950 – 1,150 mm
- Capacity: up to 40 kg
- Dimensions (not extended): H 310 x W 460 x D 190 mm
- Weight, empty: 6.2 kg

Contents:

- 5 end caps each \varnothing 10 mm and 20 mm
- 2 Warning Signs "Hybrid", "Hybrid-Switch" · 500 m Barrier Tape (width 50 mm)
- 10 VDE Screwdriver:
 - 2.5 · 3 · 3.5 · 4 mm
 - PH 1 · PH 2 · PH 3
 - T 20 · T 25 · T 30
- 15 VDE Sockets \square 6 – 22 mm
- 3 VDE \circ Screwdriver Sockets \square M 8 · M 10 · M 12
- 2 VDE Extensions \square 74 and 126 mm
- 1 VDE Reversible Ratchet \square
- 1 piece each: VDE Universal Pliers 250 mm · VDE Heavy-Duty Diagonal Cutter 180 mm · VDE High-Leverage Diagonal Cutter 160 mm · VDE Flat Nose Pliers 160 mm · VDE Snipe Nose Pliers, curved jaws 200 mm · VDE Combination Pliers 200 mm · VDE Cable Stripping Knife

Trolley Case

- Pushing or pulling is possible
- Rubberised, bearing big castors
- Tilt-resistant due to wide wheelbase
- Sturdy case made of break-proof X-ABS
- With double aluminium frame
- Sturdy tool panels



HAZET
No.

EAN-No.
4000896+

150/43

173204



Attachable and Portable Tool Box Cockpit



Tool Case



The third dimension for the *Assistant*

Attachable and Portable Tool Box Cockpit

- The space saving miracle: Immediate access – 80% of the most common tools are always at hand
- Same storage capacity as two drawers offering more place for further tools
- Suitable for *Assistant* 178, 179 and 180
- Tool box is quickly removable
- Keeps the working top tidy for assembly work
- Ergonomic inclination of 15° providing high user comfort
- Removable and attachable lid with swivelling handle
- Simultaneous locking for tool box "Cockpit" and Tool Trolley "Assistant" available on demand
- Weight: approx. 14 kg (incl. tools)
- Dimensions: H 343 x W 188 x D 516 mm

Contents:

- 600 N-7 8 9 10 12 13
14 15 16 17 18 19
- 760 N-1 2
- 802-40 55 65
- 802-PH 1 PH 2
- 802-T 20 H T 25 H T 27 H T 30 H
- 850-4 5 5,5 6 7 8
9 10 11 12 13 14
- 8501-3 4 5 6 8
- 8507-PZ 1 PZ 2
- 863 P 866 U 867-2 868 869
- 900-10 11 12 13 14 15 16 17
18 19 20 21 22 24 27 30
- 916 SP 917-5 918-10 920
- 1803-22 1841 A-22



HAZET No.	EAN-No. 4000896+
HAZET Cockpit with 70 Pc. Tool Assortment 190-20/70	162529
HAZET-Cockpit, empty	
• For individual equipment with additional tools	
• Mobile and always at hand	
• Loading capacity max. 15 kg	
190-20	164677
Cockpit retaining plate (right) with accessories for Assistant 178, 179, 179 XL	
190-20-1	163540
Cockpit retaining plate (rear) with accessories for Tool Trolley Assistant 178 and 179	
190-20-2	163533

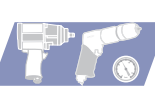

Metal Tool Box with Assortment



H 200 x W 530 x D 200 mm

Tool Box 190 L, complete with assortment of 80 pieces and padlock

Contents:

- 190 L
- 450 N-6 x 7 8 x 9 10 x 11 12 x 13 14 x 15
16 x 17 18 x 19 21 x 22 24 x 27 30 x 32
- 630-6 x 7 8 x 9 10 x 11 12 x 13 14 x 15
16 x 17 18 x 19 21 x 22 24 x 27 30 x 32 36 x 41
- 650-20
- 730-3 6 740-3 745 a-2 4 746-2 760 N-1 2
- 803-25 30 35 40 55 80
- 803-PH 1 PH 2 PH 3 PZ 1 PZ 2
- 824
- 900-10 11 12 13 14 15 16 17 18
19 21 22 24 26 27 28 30 32
- 915 916 SP 917-5 918-10 920
- 986-5 6 8 10
- 1802 M-22 1841 a-3 1952-35
- 2100-03 04 05 06 08 10
- 2140-5 2154

HAZET No.	EAN-No. 4000896+
190/80	048922

Metal Tool Box, empty

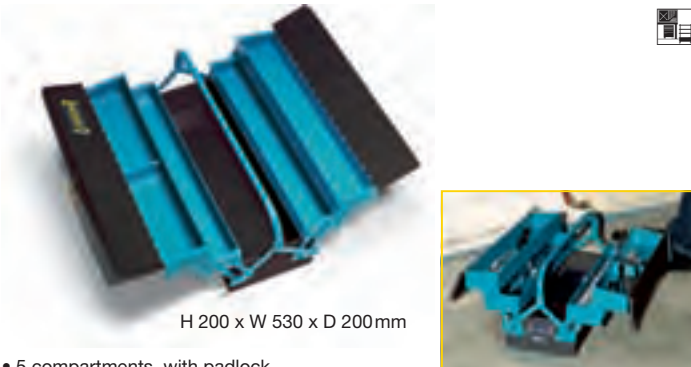

H 200 x W 530 x D 200 mm

- 5 compartments, with padlock
- Sturdy and blue/black design
- Stove-enamelled, HAZET-BLUE® and black

HAZET No.	EAN-No. 4000896+
190 L	007462

Plastic Tote Tray



H 215 x W 396 x D 294 mm

- Open and practical
- With metre/inch scale at the top
- Suitable for transporting liquids and cans
- Rugged **aluminium handle**
- Solvent resistant plastic material, HAZET-BLUE®
- Stackable

Made in Germany

HAZET No.	EAN-No. 4000896+
190 L-1	133901

Plastic Tool Box



190 L-2
H 215 x W 470 x D 250 mm



190 L-3
H 270 x W 550 x D 250 mm

Mobile workplace

- For professionals and demanding hobbyists
- Very sturdy design
- Compact dimensions with highest possible storage capacity
- Safe carrying due to tough aluminium handle
- Sturdy aluminium latches
- Two folding-down trays
- Plastic, HAZET-BLUE®/ black

Made in Germany

HAZET No.	EAN-No. 4000896+
Two removable boxes for small parts in the inside of the lid 190 L-2	150533
Three removable boxes for small parts in the inside of the lid 190 L-3	133987

Tool Case



- Practical and exclusive "Slim-Line" case (only 105 mm high) made of plastic
- For universal applications, e.g. for hobby, house and garden
- Clear and safe tool arrangement in high-quality two coloured soft foam inserts – missing tools are noticed immediately
- Inserts with clamping effect – tools cannot fall down
- Covered compartment for small parts
- **56 pieces**

Contents:

- 450 N-6 x 7 8 x 9 10 x 11 12 x 13 14 x 15 16 x 17 18 x 19 21 x 22
- 760 N-2
- 802-40 55 65 802-PH 1 PH 2 802-PZ 2 839-1
- 880-8 10 11 12 13 14 15 16 17 18 19 20 21 22
- 8816 P 8821-3 6 1803-22 1979-40 1981
- 2100-02 03 04 05 06 07 08
- 2115-T 9 T 10 T 15 T 20 T 25 T 27 T 30 T 40
- 2140-5 2154-2 2157 2158

HAZET No.	EAN-No. 4000896+
1520/56	111183



Tool Assortments



Tool Assortments

Tool Assortment



Mechanic's basic assortment for modern car repairs 117 pieces

- In Safety-Insert-System – missing tools are noticed immediately
- Inserts suitable for HAZET *Assistant* 168, 169 N, 170, 173, 174, 176-1, 177, 177 W, 178, 179, 179 W, 179 XL, 180

Contents:

① **163-57/56**

850-4 5 5,5 6 7 8
9 10 11 12 13 14

8501-3 4 5

863 P 865 866 U 867-2 868 869

900-10 11 12 13 14 15 16

17 18 19 20 21 22 23

24 26 27 28 30 32 34

915 916 SP 917-5 918-10 920

② **163-60/22**

730-3 6 746-1

748 B-3 4 5 6

824

1952-35 1976

2105 Lg/9 H 2140-5

2147 MS 2154-2

③ **163-58/27**

600 N-6 7 8 9 10 11 12 13 14
15 16 17 18 19 21 22 24

801 K-55 801 K-PH 2

803-25 30 35 40 65 80

803-PH 1 PH 2

④ **163-59/12**

630-6 x 7 8 x 9 10 x 11
12 x 13 14 x 15 16 x 17
18 x 19 20 x 22 21 x 23

760 N-2

1802 M-222

1841 A-22



Tool Assortment



Tool Assortment 193 pieces

- In HAZET plastic drawer inserts
- Especially for HAZET *Assistant*

Contents:

① **161-28 P/17**

600 N-6 7 8 9 10 11 12 13 14 15 16 17 18 19 21 22 24

② **450 N/8**

450 N-6 x 7 8 x 9 10 x 11 12 x 13 14 x 15 16 x 17 18 x 19 21 x 22

③ **161-39 P/8**

630-6 x 7 8 x 9 10 x 11 12 x 13 14 x 15 16 x 17 18 x 19 21 x 22

④ **161-22 P/4**

823 824 1846 a-2 1846 c-2

⑤ **161-53P/27**

900-10 11 12 13 14 15 16 17 18 19 20

21 22 23 24 26 27 28 30 32 34

915 916 SP 917-5 918-10 920

⑥ **161-42 P/17**

880-10 11 12 13 14 15 16 17 18 19 21 22

8816 P 8820 8821-3 6 10

⑦ **161-50 P/30**

850-4 5 5,5 6 7 8 9 10 11 12 13 14

8501-3 4 5 6 8

8503-0,6 x 3,5 1 x 5,5 1,2 x 8

8506-PH 1 PH 2 8507-PZ 1 PZ 2

863 P 865 866 U 867-2 868 869

⑧ **161-23 P/3**

760 N-2 1802-22 1841 a-22

⑨ **803/13**

801 K-55 801 K-PH 2 803-25 30 35 40 65 80

803-PZ 1 PZ 2 803-PH 1 PH 2 PH 3

⑩ **161-52 P/58**

609-E 6 x E 8 E 10 x E 12 E 14 x E 18 E 20 x E 24

803-T 6 T 7 T 8 T 9 T 10 T 15 T 20 T 25 T 27 T 30

850-E 4 E 5 E 6 E 7 E 8 880-E 10 E 11 E 12 E 14

8802-T 40 T 45

900-E 16 E 18 E 20 E 24

992-T 50 T 55 T 60

2115-T 6 T 7 T 8 T 9 T 10 T 15

T 20 T 25 T 27 T 30 T 40

2223-T 6

2223-T 7 H T 8 H T 9 H T 10 H T 15 H

T 20 H T 25 H T 27 H T 30 H T 40 H

2223 Lg-T 25 2250-1 2 2264

⑪ **161-24 P/8**

730-3 6 746-1 748 b-3 4 5 6 2140-5



HAZET
No.

0-7/117

EAN-No.
4000896+

120116

HAZET
No.

0-9/193

EAN-No.
4000896+

110292

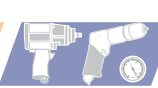

Tool Assortment



VW Tool Assortment



Tool assortment for industry

95 pieces

Contents:

- 279-6 10
- 450 N-6 x 7 8 x 9 10 x 11 12 x 13 14 x 15
16 x 17 18 x 19 21 x 22 24 x 27 30 x 32
- 630-6 x 7 8 x 9 10 x 11 12 x 13 14 x 15
16 x 17 18 x 19 21 x 22 24 x 27 30 x 32
- 730-3 6 740-3
- 745 a-2 4 746-2
- 760 N-1 2 3
- 803-25 30 35 40 55 80 100
- 803-PH 1 PH 2 PH 3 PZ 1 PZ 2
- 850-4 4,5 5 5,5 6 7 8
9 10 11 12 13 14
- 863 P 864
- 865 866 U
- 867-2 868
- 869
- 900-10 11 12 13 14 15 16
17 18 19 21 22 24 26
27 28 30 32 34
- 915 916 SP 917-5
- 918-10 920
- 1802 M-22 1841 M a-33
- 1952-35 1980 N 1981
- 2140-5 2154-2 2157-1



Tool assortment for the

VOLKSWAGEN-Group

109 pieces

• In HAZET plastic drawer inserts

Contents:

- 450 N-6 x 7 8 x 9 10 x 11 12 x 13 14 x 15
16 x 18 17 x 19 20 x 22 24 x 27 30 x 32
- 600 N-6 7 8 9 10 11 12 13
14 15 16 17 18 19 21 22 24
- 630-6 x 7 8 x 9 10 x 11 12 x 13
14 x 15 16 x 17 18 x 19 20 x 22
21 x 23 24 x 26 25 x 28 27 x 32
- 731-5 745-1 746-1
- 748 a-2 748 b-2 6 748 c-8
- 760 N-2
- 802-30 40 55 65 80
- 802-PH 1 PH 2 PH 3
- 801 K-55 801 K-PH 2
- 824
- 8816 F
- 900-10 11 12 13 14 15 16 17 18
19 20 21 22 24 27 30 32
- 900 Z-8 9 19 30
- 916 SP 917-5
- 918-10 920 919-1 5
- 985-12 17 986 Lg-10
- 986 S Lg-8
- 990 S Lg-10 12
- 1802 M-222 1841 A-22
- 1953-35
- 2105 Lg-015 02 025 03 04 05 06 08 10
- 2140-5
- 2505-2 2587
- 4555 N 4561



AUDI Standard Tool Assortment



Standard assortment for the VOLKSWAGEN group
219 pieces

• In Safety-Insert-System

Contents:

- 163-522 x 50 180-38
- 600 N-6 7 8 9 10 11 12 13 14 15
16 17 18 19 21 22 24 27 30 32
- 606-8 10 12 13 17 19
- 609-E 6 x E 8 E 10 x E12 E 14 x E18 E 20 x E24
- 612-10 x 11
- 630-6 x 7 8 x 9 10 x 11 12 x 13 14 x 15
16 x 17 18 x 19 21 x 22 24 x 27 30 x 32
- 650-20
- 730-3 6 746-1 748 B-3 4 5 6
- 759 N-2
- 801 K-55 801 K-PH 2
- 803-25 30 35 40 65 80
- 803-PH 1 PH 2 PH 3
- 803-T 6 T 7 T 8 T 9 T 10 T 15 T 20 T 25 T 27 T 30
824
- 850-4 5 5,5 6 7 8 9 10 11 12 13 14
- 850-E 4 E 5 E 6 E 7 E 8
- 8501-3 4 5 6 8
- 8503-0,6 x 3,5 1 x 5,5 1,2 x 8
- 8506-PH 1 PH 2 8507-PZ 1 PZ 2
- 863 P 865 866 U 867-2 868 869
- 880-10 11 12 13 14 15 16 17 18 19 21 22
- 880-E 10 E 11 E 12 E 14
- 8802-T 40 T 45
- 8816 P 8820 8821-3 6 10
- 900 Z-10 11 12 13 14 15 16 17 18 19
20 21 22 23 24 26 27 28 30 32 34
- 900-E 16 E 18 E 20 E 24
- 915 916 SP 919-1 5 10 920
- 986-5 6 7 8 10 12 14 17 19
- 986 KK-6 7 8 10
- 990-8 10 12 14 16 18
- 990 Lg-8 14 990 S Lg-10 12
- 992-T 50 T 55 T 60
- 1802 M-22 1841 MB-33 1850 M-22
- 2105 Lg/9 H
- 2115-T 6 T 7 T 8 T 9 T 10 T 15 T 20 T 25 T 27 T 30 T 40
- 2130 2140-5
- 2223-T 6
- 2223-T 7 H T 8 H T 9 H T 10 H T 15 H
T 20 H T 25 H T 27 H T 30 H T 40 H
- 2223 Lg-T 25 2250-1 2250-2 2264

HAZET No.

0-2500-163/219

EAN-No.
4000896+

153633



AUDI Expansion Tool Assortment



Expansion assortment for VOLKSWAGEN-Group
70 pieces

• In Safety-Insert-System

Contents:

- 163-130L
- 163-522 x 50
- 426-6 7 8
- 428-8 10 13
- 450 N-6 x 7 8 x 9 10 x 11 12 x 13 14 x 15
16 x 17 18 x 19 21 x 22 24 x 27 30 x 32
- 755-10 A
- 803 Lg-T 15 20 25 30
- 828-T 45
- 858-1
- 880 G-10 11 12 13 14 15 16 17 18 19
- 880 TZ-10 11 12 13 14 15 16 17 18 19
- 8858-1 2
- 900 SZ-32 34 36
- 903 S Lg-17 19
- 918-23 958-1 2
- 1014 1015-1 1058-2
- 1802 M-33 1803 M-11 1841 MA-11
- 1845 A-19 1845 B-19 1845 C-19 1845 D-19
- 2211-4 5
- 2212-6 8 10
- 6420 B 6420 C

HAZET No.

0-2500-163/70

EAN-No.
4000896+

153640



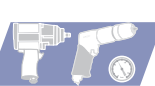

MERCEDES-BENZ Tool Assortment

MERCEDES-BENZ Tool Assortment



- 730-3 6 746-1
- 748 B-3 4 5 6
- 755-10 A 759 N-2
- 801 K-55 801 K-PH 2
- 803 Lg-T 15 20 25 30
- 803-25 30 35 40 65 80
- 803-PH 1 PH 2 PH 3
- 803-T 6 T 7 T 8 T 9 T 10 T 15 T 20 T 25 T 27 T 30
- 824 828-T 45
- 850-4 5 5,5 6 7 8
- 9 10 11 12 13 14
- 850-E 4 E 5 E 6 E 7 E 8
- 8501-3 4 5 6 8
- 8503-0,6 x 3,5 1 x 5,5 1,2 x 8
- 8506-PH 1 PH 2
- 8507-PZ 1 PZ 2
- 858-1 863 P 865 866 U 867-2 868 869
- 880 TZ-10 11 12 13 14 15 16 17 18 19
- 880-10 11 12 13 14 15
- 16 17 18 19 21 22
- 880-E 10 E 11 E 12 E 14
- 880 G-10 11 12 13 14 15 16 17 18 19
- 8802-T 40 T 45
- 8816 P 8820 8821-3 6 10
- 8858-1 2
- 900 SZ-32 34 36
- 900-E 16 E 18 E 20 E 24
- 900 Z-10 11 12 13 14 15 16
- 17 18 19 20 21 22 23
- 24 26 27 28 30 32 34
- 903 S Lg-17 19
- 915 916 SP 918-23 919-1 5 10 920 958-1 2
- 986 KK-6 7 8 10
- 986-5 6 7 8 10 12 14 17 19
- 990 Lg-8 14
- 990 S Lg-10 12
- 990-8 10 12 14 16 18
- 992-T 50 T 55 T 60
- 1014 1015-1 1058-2
- 1802 M-22 33 1803 M-11 1841 MA-11 1841 MB-33 1850 M-22
- 1845 A-19 1845 B-19 1845 C-19 1845 D-19
- 1952-35 1976
- 2105 Lg/9 H
- 2115-T 6 T 7 T 8 T 9 T 10
- T 15 T 20 T 25 T 27 T 30 T 40
- 2130 2140-5
- 2147 2154 N-5 2154-10 2160 2165-2
- 2211-4 5
- 2212-6 8 10
- 2223 Lg-T 25
- 2223-T 6
- 2223-T 7 H T 8 H T 9 H T 10 H T 15 H
- T 20 H T 25 H T 27 H T 30 H T 40 H
- 2250-1 2250-2 2264
- 6420 B 6420 C

Assortment for MERCEDES-BENZ passenger cars
296 pieces



• In Safety-Insert-System

Contents:

- 163-130 L (2x) 163-522 x 50 (6x) 180-38
- 426-6 7 8
- 428-8 10 13
- 450 N-6 x 7 8 x 9 10 x 11 12 x 13 14 x 15
- 16 x 17 18 x 19 21 x 22 24 x 27 30 x 32
- 600 N-6 7 8 9 10 11 12 13 14 15
- 16 17 18 19 21 22 24 27 30 32
- 606-8 10 12 13 17 19
- 609-E 6 x E 8 E 10 x E 12 E 14 x E 18 E 20 x E 24
- 612-10 x 11
- 630-6 x 7 8 x 9 10 x 11 12 x 13 14 x 15
- 16 x 17 18 x 19 21 x 22 24 x 27 30 x 32
- 650-20

HAZET
No.

EAN-No.
4000896+

0-2700-163/296

162031

**Good Tools
are a matter of trust!**

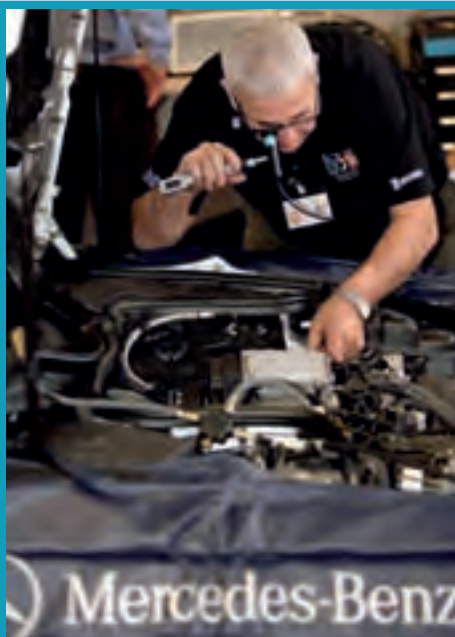

HAZET – Official tool supplier of Mercedes-Benz TechMasters

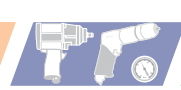

**MERCEDES-BENZ
Tool Assortment**

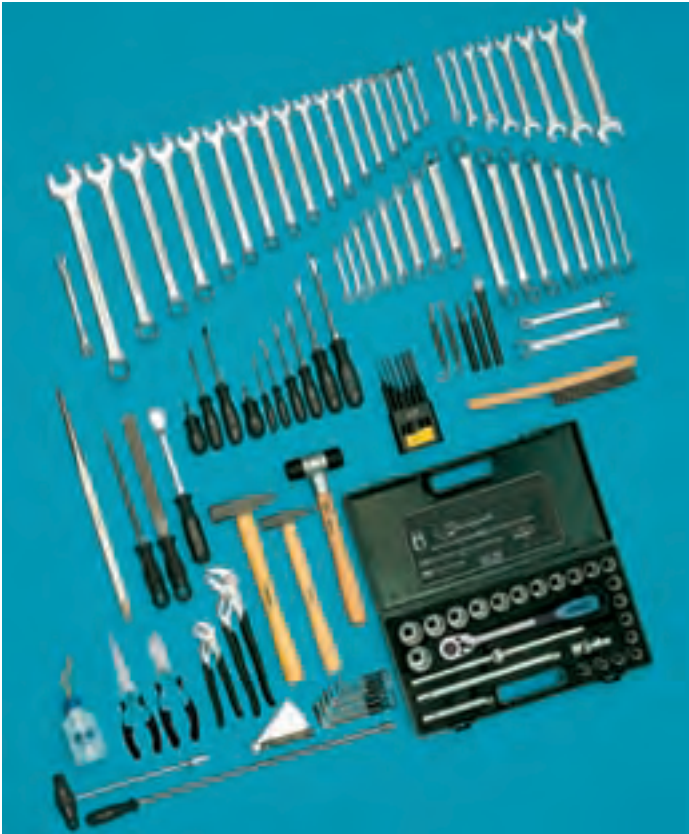

**Assortment for MERCEDES-BENZ passenger cars
117 pieces**

- Contents:
- 428-10
 - 450 N-6 x 7 8 x 9 10 x 11 12 x 13
14 x 15 16 x 17 18 x 19 21 x 22
 - 600 N-7 8 9 10 11 12 13 14 15
16 17 18 19 21 22 24 27
 - 610 N-6 x 7 8 x 9 10 x 11 12 x 13
14 x 15 16 x 17 18 x 19 21 x 22
 - 612 N-10 x 11
 - 612-12 x 14 16 x 18 17 x 19
 - 630-6 x 7 8 x 9 10 x 11 12 x 13 14 x 15
16 x 17 18 x 19 20 x 22 21 x 23
 - 731-5 745 a-2 746-2
 - 748 b-2 3 4 5 6 8
 - 760 N-1 2
 - 801 K-55 801 K-PH 2
 - 803-25 30 35 40 65 80 803-PH 1 PH 2
 - 818-2 819-PH 1 + PH 2 824
 - 900-10 11 12 13 14 15 16
17 18 19 20 21 22 23
24 26 27 28 30 32 34
 - 915 916 SP 917-5 918-10 920
 - 1802-22 1841 a-33 1952-35 1976
 - 2100-03 04 05 06 08 10
 - 2120-8 2122-8 2130
 - 2140-2 5 2147 2160 2165-2



**MERCEDES-BENZ Tool Assortment
for Commercial Vehicles**



**Assortment for MERCEDES-BENZ
commercial vehicles
229 pieces**

- In Safety-Insert-System
- Contents:
- 450 N-6 x 7 8 x 9 10 x 11 12 x 13 14 x 15 16 x 17
18 x 19 21 x 22 24 x 27 30 x 32 34 x 36 36 x 41
 - 600 N-6 7 8 9 10 11 12 13 14 15
16 17 18 19 21 22 24 27 34
 - 609-E 6 x E 8 E 10 x E 12 E 14 x E 18 E 20 x E 24
 - 630-6 x 7 8 x 9 10 x 11 12 x 13 14 x 15 16 x 17 18 x 19
20 x 22 21 x 23 24 x 26 25 x 28 27 x 32 30 x 32 36 x 41
 - 652
 - 730-3 6 746-1
 - 748 B-3 4 5 6
 - 760 N-2 4
 - 801 K-55 801 K-PH 2
 - 803-25 30 35 40 65 80
 - 803-PH 1 PH 2 PH 3
 - 803-PZ 1 PZ 2
 - 803-T6 T 7 T 8 T 9 T 10 T 15 T 20 T 25 T 27 T 30
823 824
 - 850-4 5 5,5 6 7 8 9 10 11 12 13 14
 - 850-E 4 E 5 E 6 E 7 E 8
 - 8501-3 4 5 6 8
 - 8503-0,6 x 3,5 1 x 5,5 1,2 x 8
 - 8506-PH 1 PH 2 8507-PZ 1 PZ 2
 - 858-1 863 P 865 866 U 867-2 868 869
 - 880-10 11 12 13 14 15 16 17 18 19 21 22
 - 880-E 10 E 11 E 12 E 14
 - 8802-T 40 T 45
 - 8816 P 8820 8821-3 6 10 8858-1 2
 - 900 Z-10 11 12 13 14 15 16 17 18 19
20 21 22 23 24 26 27 28 30 32 34
 - 900-E 16 E 18 E 20 E 24 903 S Lg-17 19
 - 915 916 SP 919-1 5 10 920 958-1 2
 - 992-T 50 T 55 T 60
 - 1058-2 1802-22 1841 A-22
 - 1845 A-19 1845 B-19 1845 C-19 1845 D-19
 - 1952-50 1976-1
 - 2115-T 6 T 7 T 8 T 9 T 10 T 15 T 20 T 25 T 27 T 30 T 40
 - 2119-8 2120-8 2122-8 2123-8
 - 2130 2140-5 10
 - 2154 N-5 2154-10 2160
 - 2223-T 6 T 7 H T 8 H T 9 H T 10 H T 15 H
T 20 H T 25 H T 27 H T 30 H T 40 H
 - 2223 Lg-T 25 2250-1 2250-2 2264



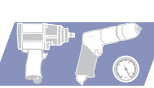

BMW Tool Assortment



**Assortment for BMW passenger cars
258 pieces**

- Long-lasting basic equipment for the work place – maintenance work –
- In Safety-Insert-System
Suitable for HAZET-*Assistent* 173, 179, 179 W, 179 XL, 180

Contents:

- 426-6 7
- 450 N-6 x 7 8 x 9 10 x 11 12 x 13
14 x 15 16 x 17 18 x 19 21 x 22
- 600 N-6 7 8 9 10 11 12
13 14 15 16 17 18 19
21 22 24 27 30 32
- 609-E 6 x E 8 E 10 x E 12 E 14 x E 18 E 20 x E 24
- 612N-10 x 11
- 630-6 x 7 8 x 9 10 x 11 12 x 13
14 x 15 16 x 17 18 x 19 21 x 22
- 730-3 6 746-1
- 748 b-3 4 5 6 8
- 757-10 760 N-2
- 802-30 40 55 65 80 100 120
- 802-PH 1 PH 2 PH 3
- 801 K-55 801 K-PH 2
- 803-T 6 T 7 T 8 T 9 T 10
T 15 T 20 T 25 T 27 T 30
- 824
- 850-4 5 5.5 6 7 8
9 10 11 12 13 14
- 850 Lg-4 5 5.5 6 7 8 9 10 11 12 13
- 850-E 4 E 5 E 6 E 7 E 8
- 8501-3 4 5 6 8
- 8503-0.6 x 3.5 1 x 5.5 1.2 x 8
- 8506-PH 1 PH 2
- 8507-PZ 1 PZ 2
- 858-1 863P 865
- *866U 867-2 868 869
- 880-7 8 9 10 11 12 13 14
15 16 17 18 19 21 22
- 880 Lg-10 11 12 13
- 880 G-10 11 12 13 14 15 16
- 880-E 10 E 11 E 12 E 14
- 880 G-E 8 E 10
- 8802-T 40 T 45
- 8808-6 8 10
- 8816 GK 8816 P
- 8820 8821-3 6 10
- 8858-1 2
- 900-10 11 12 13 14 15 16 17 18
19 20 21 22 24 27 30 32
- 900-E 16 E 18 E 20 E 24
- 986-5 6 7 8 10 12 14 17
- 992-T 50 T 55 T 60



BMW Tool Assortment

- 915 916 SP 917-5 918-10 23 919-1 920
- 958-1 2
- 903S Lg-17
- 903S Lg-19
- 1557 TS-1
- 1802-22
- 1841 A-22 1846 A-2 1846 B-2 1846 C-2 1846 D-2
- 1850-22 1952-40 1975 1976-2
- 2105 Lg-015 02 025 03 04 05 06 08 10
- 2115-T 6 T 7 T 8 T 9 T 10 T 15 T 20 T 25 T 27 T 30 T 40
- 2140-4 2152/3 2154-5
- 2215-PH 1 PH 2 PH 3
- 2223-T 6
- 2223-T 7 H T 8 H T 9 H T 10 H T 15 H
T 20 H T 25 H T 27 H T 30 H T 40 H
- 2223 Lg-T 25
- 2250-1 2
- 2264 4968-2

HAZET No.	EAN-No. 4000896+
0-2900-163/258	151240



**Assortment for BMW passenger cars
258 pieces**

- Long-lasting basic equipment for the work place – maintenance work –
- In HAZET plastic drawer inserts
Suitable for HAZET *Assistent* 177 and 178
Contents see 0-2900-163/258



HAZET No.	EAN-No. 4000896+
0-2900/258	121236



Recommended by BMW:
HAZET Tool Trolleys with special BMW Tool Assortment





PORSCHE Tool Assortment



Tool assortment for PORSCHE
218 pieces

Contents:

- 440-5,5 6 11 12 13 14
- 600 N-20 21 22 24 25 27 29 30 32 36
- 603-6 8 9 10 12 13
- 14 15 16 17 18 19
- 609-E 6 x E 8 E 10 x E 12 E 14 x E 18 E 20 x E 24
- 612-8 x 10 11 x 13 12 x 14 17 x 19
- 630-10 x 11 12 x 13 14 x 15
- 16 x 18 17 x 19 20 x 22
- 645-10 x 11 12 x 13
- 731-2 5 745 a-6 745-4 746-2 748 b-4 760 N-2
- 801 K-35 55 801 K-PH 1 PH 2
- 803-20 25 30 35 55 65 80
- 803-PH 1 PH 2 PH 3 821-1
- 803-T 8 T 9 T 10 T 15 T 20 T 25 T 30
- 850-4 5 6 7 8 9
- 10 11 12 13 14
- 850-E 5 E 6 E 7 E 8
- 880-E 10 E 12 E 14
- 8501-3 4 5 6 8 8503-0,6 x 3,5 0,8 x 4 1 x 5,5 1,2 x 8
- 8506-PH 1 PH 2 PH 3 PH 4 8507-PZ 1 PZ 2 PZ 3
- 858-1 863 P 865 866 U 867-2 868 869
- 880-6 7 8 9 10 11 12 13
- 14 15 16 17 18 19 21 22
- 8801-4 5 6 8
- 8803-1 x 5,5 1,2 x 8 1,6 x 10
- 8806-PH 1 PH 2 PH 3
- 8815 8816 P 8820
- 8821-3 5 10
- 8858-1 2
- 900 Z-10 11 12 13 14 15 16 17 18 19
- 20 21 22 23 24 26 27 28 30 32
- 900-E 10 E 12 E 14
- 915 916 SP 917-5
- 918-10 920 958-1 2
- 986 Lg-8 10 992-T 55 T 60
- 1802 M-22 1816-22 1841 M b-33 1846 a-2
- 1846 c-2 1846 d-2 1952-35 1976
- 2100-025 03 04 05 06 08 10 12 14
- 2122-10
- 2140-5 2143 2147 2150
- 2223-T 10 T 20 T 25 T 27 T 30
- 2223-T 30 H 2223 Lg-T 25
- 2224-T 40 T 45 T 50
- 2250-1 3 5
- 2255-1



With HAZET in Pole Position!



OFFICIAL SUPPLIER
PORSCHE
MOTORSPORT



PORSCHE
relies on:
HAZET Service
Tool Trolley and
Assortments

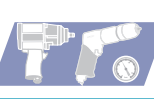

Tool Assortment



Tool assortment for electricians
18 pieces



Contents:

- 803 VDE-25 35 40 55 65
- 803 VDE-PH 0 PH 1 PH 2
- 839-1
- 1803 VDE-33 1816 VDE-22 1826 VDE-22
- 1841 a VDE-22 1841 b VDE-33
- 1850 VDE-22 1862
- 2154 N-3 2156-1

HAZET
No.

FAN No.
4000896+

0-20/18

000265



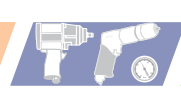

Tool Assortment for Commercial Vehicles

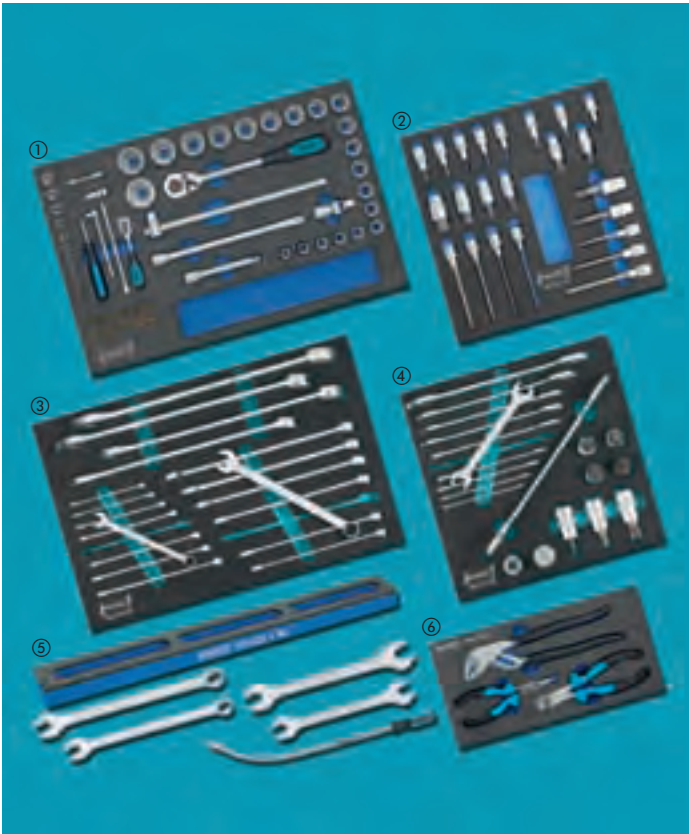

Tool Assortment for Commercial Vehicles
128 pieces



• In Safety-Insert-System

Contents:

- ① **163-57/56**
850-4 5 5,5 6 7 8
9 10 11 12 13 14
863 P 865 866 U
867-2 868 869
8501-3 4 5 6 8
8503-0,6 x 3,5 1 x 5,5 1,2 x 8
8506-PH 1 PH 2 8507-PZ 1 PZ 2
900-10 11 12 13 14 15 16
17 18 19 20 21 22 23
24 26 27 28 30 32 34
915 916 SP 917-5 918-10 920
- ② **163-119/23**
986-5 6 7 8 10 12 14 17 19
986 KK-6 7 8 10
990-8 10 12 14 16 18
990 Lg-8 14
990 S Lg-10 12
- ③ **163-210/19**
600 N-8 9 10 11 12 13 14
15 16 17 18 19 21 22
24 27 30 32 34
- ④ **163-211/20**
450 N-8 x 9 10 x 11 12 x 13 14 x 15
21 x 22 24 x 27 30 x 32 34 x 36
16 x 18 17 x 19 20 x 22
1058-1 2
1010-14 17 19 22
1012-T 60 T 80 T 100
- ⑤ **163-522 x 40**
450 N-36 x 41 46 x 50
600 N-36 41
1976
- ⑥ **163-96/3**
760 N-2 1802-22 1841 A-22

HAZET
No.

0-22/128

EAN-No.
4000896+

164745

Tool Assortment



Assortment for car body work
77 pieces

• For Tool Trolleys HAZET Assistant



Contents:

- 428-6 7 8 10 11 13
- 600 N-8 9 10 11 12 13
14 15 17 19 22 24
- 745 a-6 745-4 746-1
- 757-10 760 N-2 799-3
- 801 K-55
- 803-25 55 65 80 100
- 803-PH 1 PH 2 PH 3
- 821-2
- 900-10 11 12 13 15 17 19 22
- 916 SP 917-5 918-10
- 1810-250 1850-44
- 1917 N 1919 N 1920 N 1921
- 1922 1923 1927 1929-1
- 1930 1931 1934
- 1934-1 4 9 10
- 1937 K 1940
- 1950 1960-5
- 1961 L-2 1961 R-2
- 1965-1 2 3 4 5
- 2130
- 2140-3 5
- 2143 2150
- 2165-1 2

HAZET
No.

0-1900/77

EAN-No.
4000896+

000241